

D-SUB cable - VS-09-DSUB-20-LI-2,0 - 1656246

Please be informed that the data shown in this PDF Document is generated from our Online Catalog. Please find the complete data in the user's documentation. Our General Terms of Use for Downloads are valid (<http://phoenixcontact.com/download>)



Assembled D-SUB cable, shielded, 9-pos., stranded (7-wire), cable color: RAL 7000 (gray), secured using 4-40 UNC thread, IP20 protection, head 1 with socket shell 1 and straight cable outlet, head 2 with pin shell 1 and straight cable outlet, length: 2 m

RoHS

IP20

Key Commercial Data

Packing unit	1 pc
GTIN	 4 046356 029728
GTIN	4046356029728

Technical data

Environmental Product Compliance

China RoHS	Environmentally friendly use period: unlimited = EFUP-e
	No hazardous substances above threshold values

Drawings

Dimensional drawing

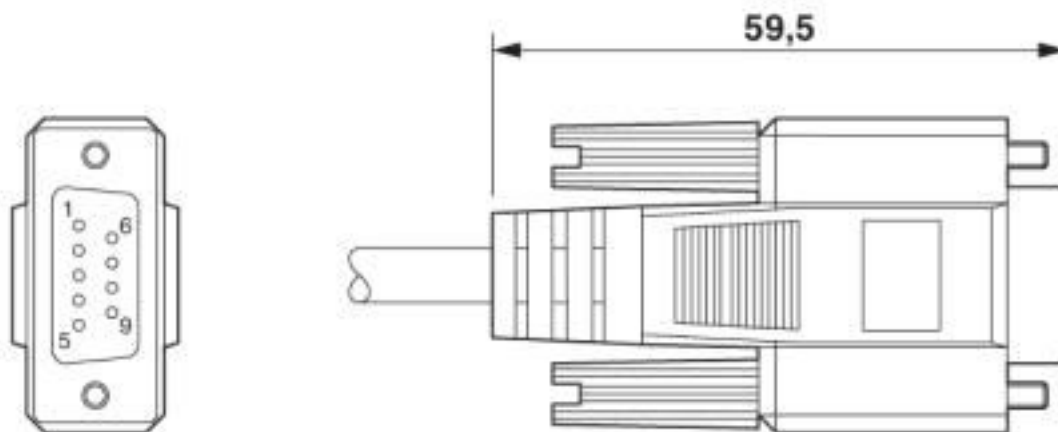

D-SUB cable - VS-09-DSUB-20-LI-2,0 - 1656246

Dimensional drawing

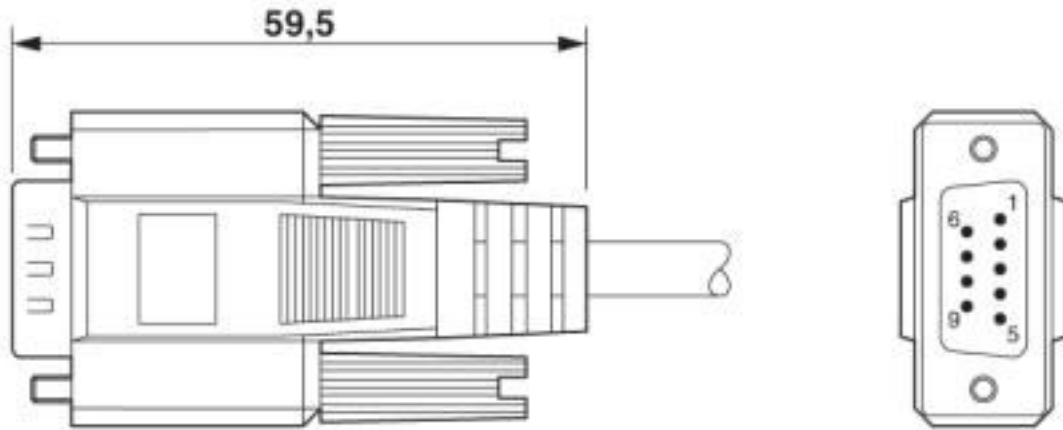

Circuit diagram

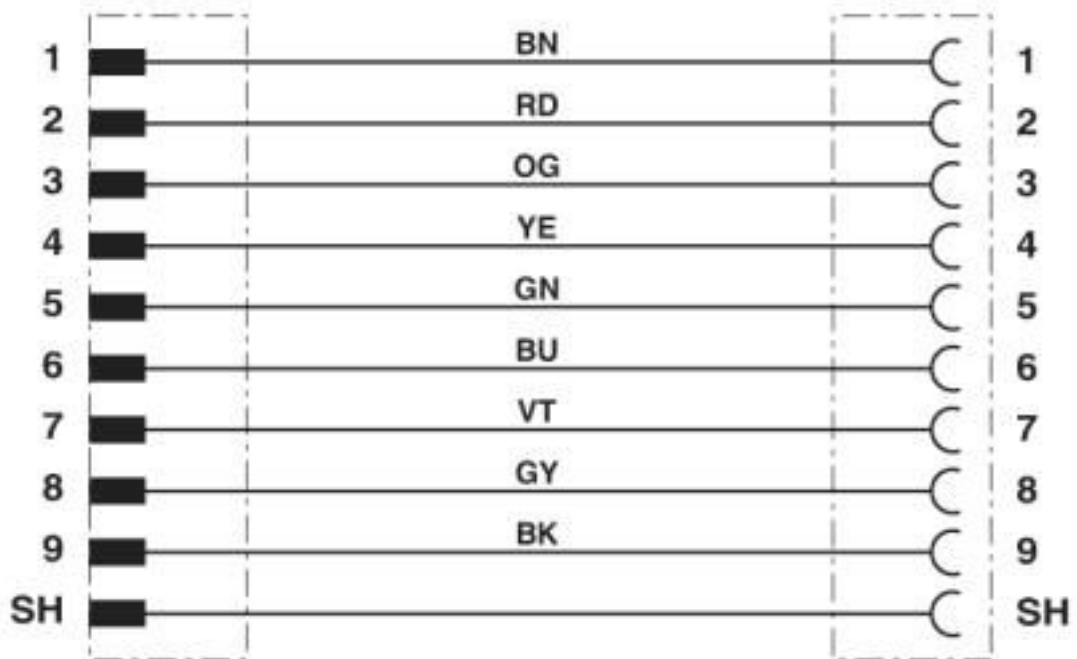

D-SUB cable - VS-09-DSUB-20-LI-2,0 - 1656246

Schematic diagram

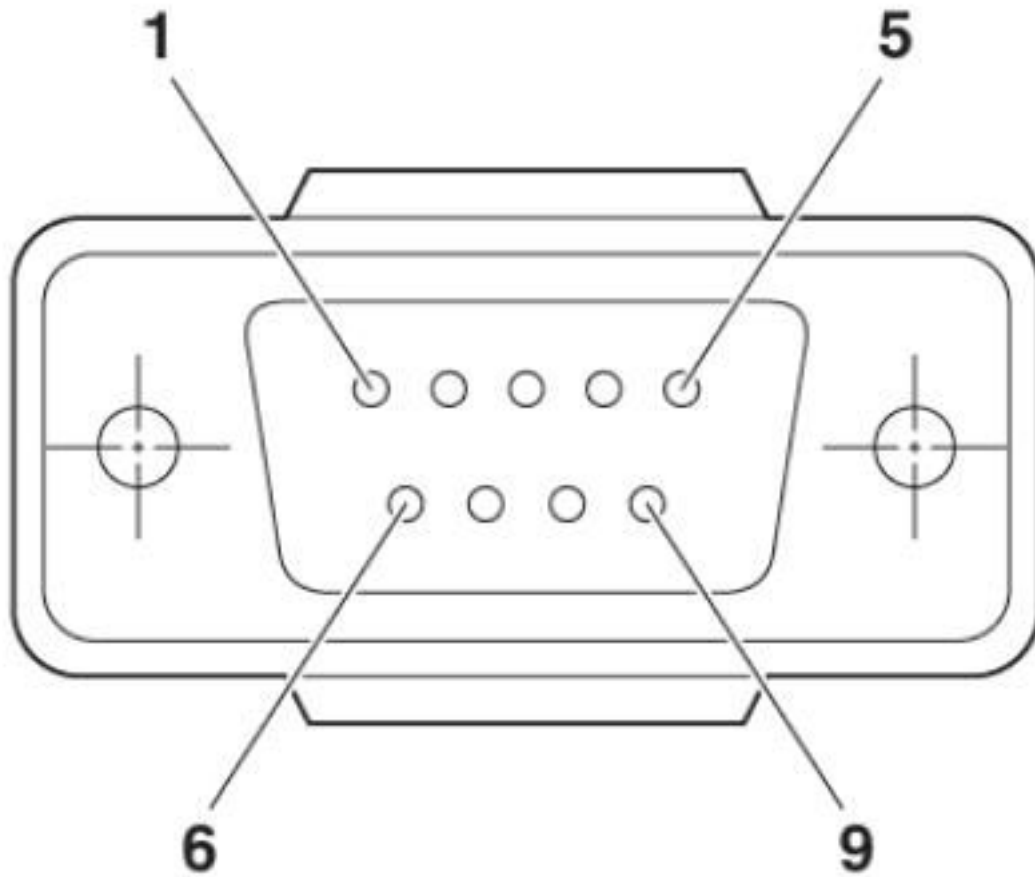

D-SUB cable - VS-09-DSUB-20-LI-2,0 - 1656246

Schematic diagram

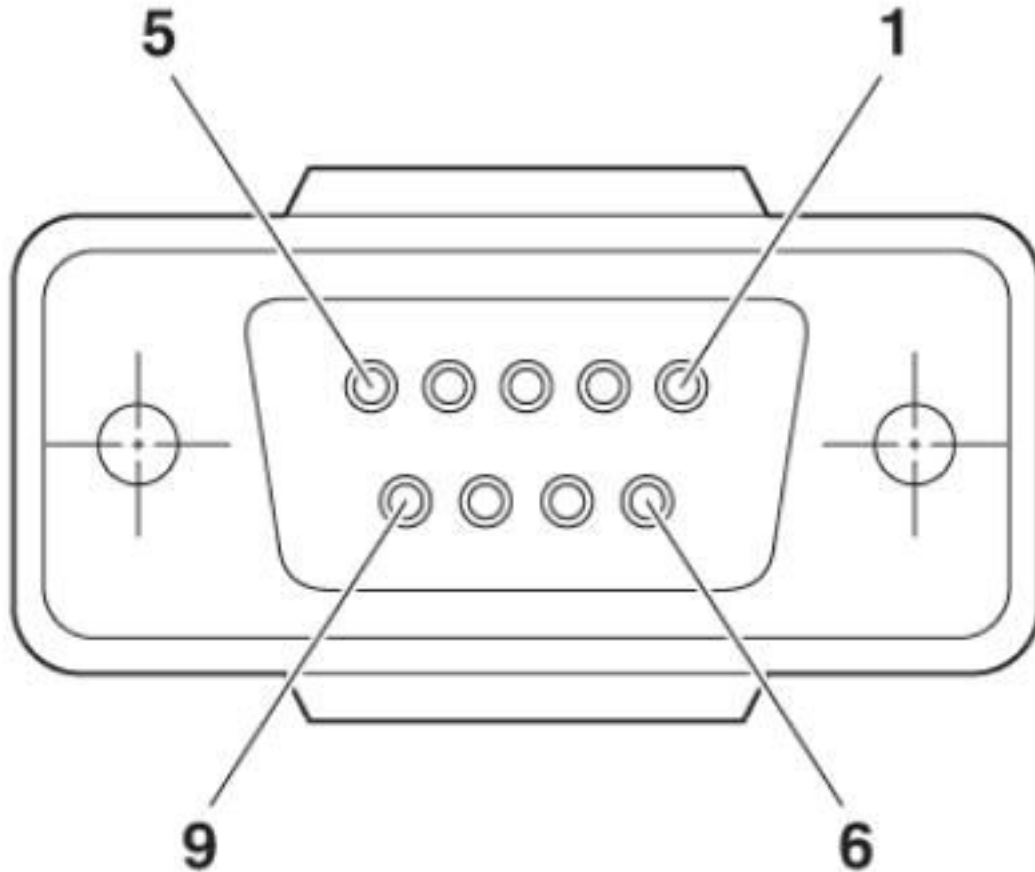

Classifications

eCl@ss

eCl@ss 10.0.1	27060390
eCl@ss 4.0	24010400
eCl@ss 4.1	24010400
eCl@ss 5.0	19030300
eCl@ss 5.1	19030300
eCl@ss 6.0	27060300
eCl@ss 7.0	27060390
eCl@ss 8.0	27060390
eCl@ss 9.0	27060390

ETIM

ETIM 2.0	EC000830
ETIM 3.0	EC001855
ETIM 4.0	EC001855
ETIM 5.0	EC001408

D-SUB cable - VS-09-DSUB-20-LI-2,0 - 1656246

Classifications

ETIM

ETIM 6.0	EC000748
ETIM 7.0	EC000748

UNSPSC

UNSPSC 6.01	31261501
UNSPSC 7.0901	31261501
UNSPSC 11	31261501
UNSPSC 12.01	31261501
UNSPSC 13.2	26121604
UNSPSC 18.0	26121604
UNSPSC 19.0	26121604
UNSPSC 20.0	26121604
UNSPSC 21.0	26121604

Approvals

Approvals

Approvals

EAC

Ex Approvals

Approval details

EAC		19060508
-----	---	----------

Phoenix Contact 2020 © - all rights reserved
<http://www.phoenixcontact.com>

PHOENIX CONTACT GmbH & Co. KG
Flachsmarktstr. 8
32825 Blomberg
Germany
Tel. +49 5235 300
Fax +49 5235 3 41200
<http://www.phoenixcontact.com>

X-ON Electronics

Largest Supplier of Electrical and Electronic Components

Click to view similar products for [D-Sub Cables](#) category:

Click to view products by [Phoenix Contact](#) manufacturer:

Other Similar products are found below :

[1200980218](#) [1200980067](#) [RB09P09P-006](#) [RB09P09P-012](#) [RB15P15P-006](#) [RB25P25P-006](#) [RB37P37P-024](#) [172-0906](#) [SHD15P15S-012](#)
[SHD15P15S-036](#) [SHD15P15S-060](#) [ACL-10137-2MM](#) [RB09P09P-024](#) [319285-3](#) [RS422-OM2](#) [SHD26P26S-060](#) [SHD44P44S-036](#) [73-](#)
[6210MM-6](#) [C200H-CN320-EU](#) [49725A 060S2](#) [73231-1321](#) [SDB-50AFFM-SL7A02](#) [49760A 060S2](#) [HDB-26AFFM-SL7A02](#) [30-9503P](#) [30-](#)
[9522P](#) [73-6220MM-6](#) [1200980058](#) [1200980066](#) [1200980078](#) [1200980052](#) [1200980093](#) [1200980028](#) [1200980021](#) [1200980127](#) [SDB-](#)
[09AFFM-SL7A02](#) [SDB-15AMMM-SL7A01](#) [BB-LDVYCBL](#) [83421-9286](#) [MLDM2L-21P-6K7-18B](#) [KSFD1](#) [MM-2J2-021-SS1-41WN](#) [HDB-](#)
[78AMMM-SL7A05](#) [SDB-37AMMM-SL7A03](#) [SDB-15AFFM-SL7A05](#) [ACC-500-163-R](#) [172-1910](#) [2900907/21.4](#) [VS-25-DSUB-20-LI-2,0](#)
[VS-25-DSUB-20-LI-5,0](#)