

Connector - SACC-M12MR-5CON-PG 7 - 1662269

Please be informed that the data shown in this PDF Document is generated from our Online Catalog. Please find the complete data in the user's documentation. Our General Terms of Use for Downloads are valid (<http://phoenixcontact.com/download>)



Connector, Universal, 5-position, Plug angled M12, Coding: A, Screw connection, knurl material: Plastic, cable gland Pg7, external cable diameter 4 mm ... 6 mm

Your advantages

- Safe use in the field, thanks to a high degree of protection
- Flexible: connectors for on-site assembly
- Screw connection: proven connection technology for a large selection of different conductors

RoHS

Key Commercial Data

| | |
|--------------|---------------------------------------------------------------------------------------------------------|
| Packing unit | 1 pc |
| GTIN |  4 017918 100452 |
| GTIN | 4017918100452 |
| Sales Key | 02 |

Technical data

Dimensions

| | |
|-----------------------------------------|---------------|
| Diameter housing | 20 mm |
| Length | 41 mm |
| External cable diameter | 4 mm ... 6 mm |
| Stripping length of the sheath | 20 mm |
| Stripping length of the individual wire | 5 mm |

Ambient conditions

| | |
|---------------------------------|----------------------------------|
| Ambient temperature (operation) | -40 °C ... 85 °C (Plug / socket) |
| Degree of protection | IP67 |

General

| | |
|------|------------------------------------------------------------------------------------------------------------------------------------------|
| Note | NOTE: Observe the permissible bending radii when laying conductors, since the degree of protection may be put in jeopardy if the bending |
|------|------------------------------------------------------------------------------------------------------------------------------------------|

Connector - SACC-M12MR-5CON-PG 7 - 1662269

Technical data

General

| | |
|-----------------------------|------------------------------------------------------------------------------------------------------|
| | forces are too high. Alleviate mechanical loads upstream of the connector, e.g. by using cable ties. |
| Rated current at 40°C | 4 A |
| Rated voltage | 48 V AC |
| | 60 V DC |
| Number of positions | 5 |
| Color handle area | black |
| Insulation resistance | ≥ 100 MΩ |
| Coding | A - standard |
| Standards/regulations | M12 connector IEC 61076-2-101 |
| Signal type/category | Universal |
| Status display | No |
| Overvoltage category | II |
| Degree of pollution | 3 |
| Connection method | Screw connection |
| Conductor cross section | 0.25 mm ² ... 0.75 mm ² (without ferrule) |
| | 0.14 mm ² ... 0.75 mm ² (with ferrule) |
| | 0.25 mm ² ... 0.75 mm ² (solid) |
| Conductor cross section AWG | 24 ... 18 (without ferrule) |
| | 26 ... 20 (with ferrule) |
| Insertion/withdrawal cycles | ≥ 50 |
| Torque | 0.4 Nm (M12 knurl) |
| | 0.2 Nm (Screw terminal blocks) |
| | 0.8 Nm ... 1 Nm (Pressure screw) |
| Tightening torque | Screw plug insert with sleeve housing as far it will go |
| Assembly instructions | The connector pin assignment can be rotated 90° to the cable outlet |
| | The wires can be connected both with ferrules and without ferrules |

Material

| | |
|----------------------------------------|---------|
| Flammability rating according to UL 94 | HB |
| Contact material | CuZn |
| Contact surface material | CuSnZn |
| Contact carrier material | PA |
| Material of grip body | PA |
| Material, knurls | Plastic |
| Sealing material | NBR |

Standards and Regulations

| | |
|----------------------------------------|-------------------------------|
| Standards/specifications | M12 connector IEC 61076-2-101 |
| Connection in acc. with standard | CUL |
| Flammability rating according to UL 94 | HB |

Environmental Product Compliance

Connector - SACC-M12MR-5CON-PG 7 - 1662269

Technical data

Environmental Product Compliance

| | |
|------------|-----------------------------------------------------------------------------------------------------|
| REACH SVHC | Lead 7439-92-1 |
| China RoHS | Environmentally Friendly Use Period = 50 years |
| | For details about hazardous substances go to tab "Downloads", Category "Manufacturer's declaration" |

Drawings

Dimensional drawing

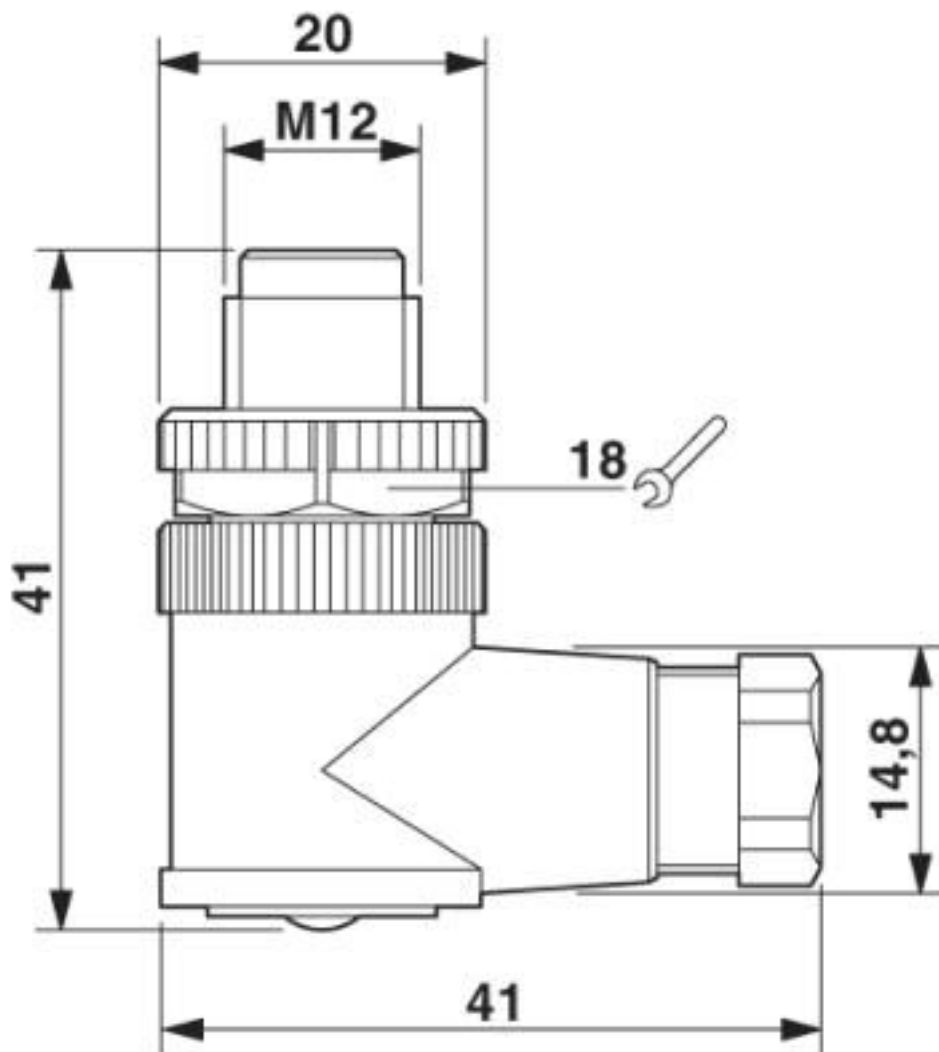

M12 x 1 male plug, angled

Connector - SACC-M12MR-5CON-PG 7 - 1662269

Schematic diagram

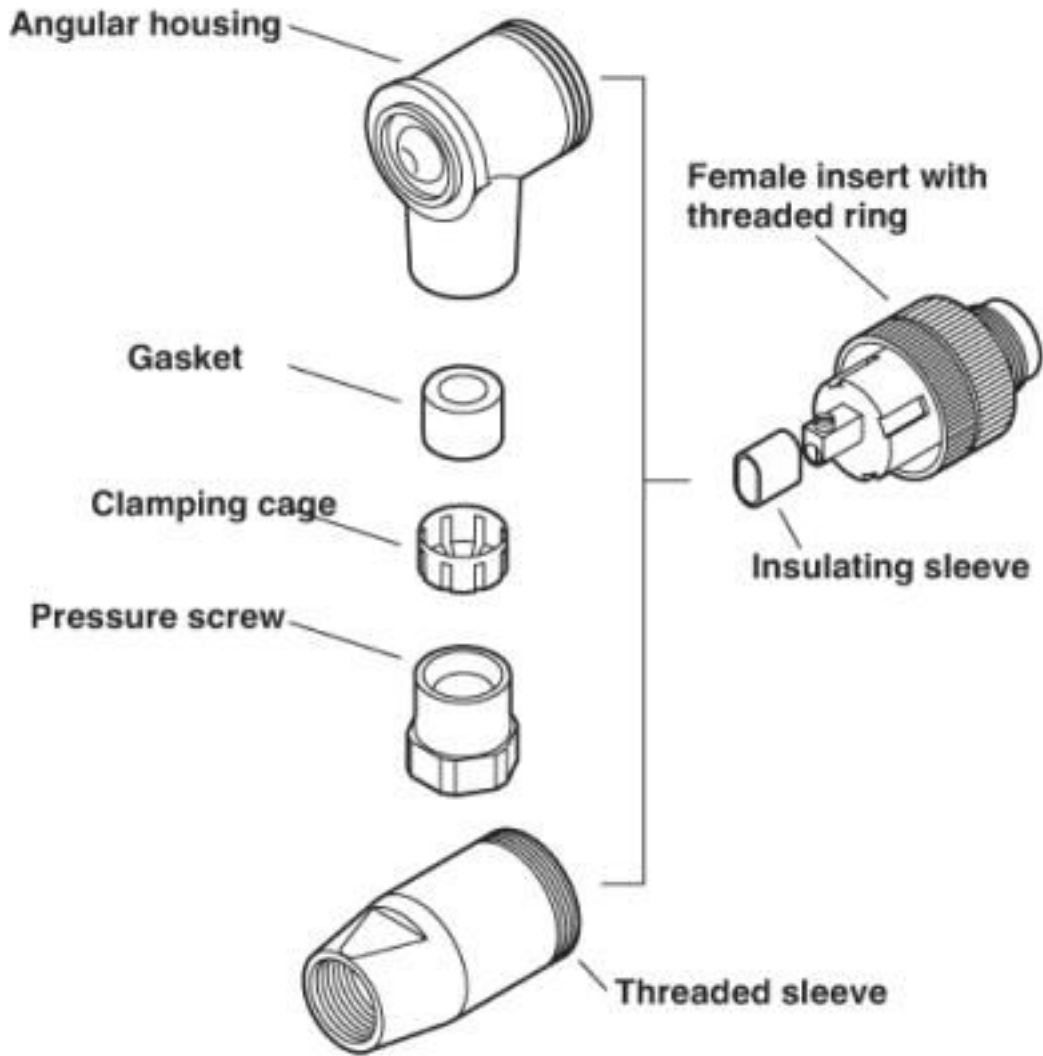

Male/Female M12

Connector - SACC-M12MR-5CON-PG 7 - 1662269

Schematic diagram

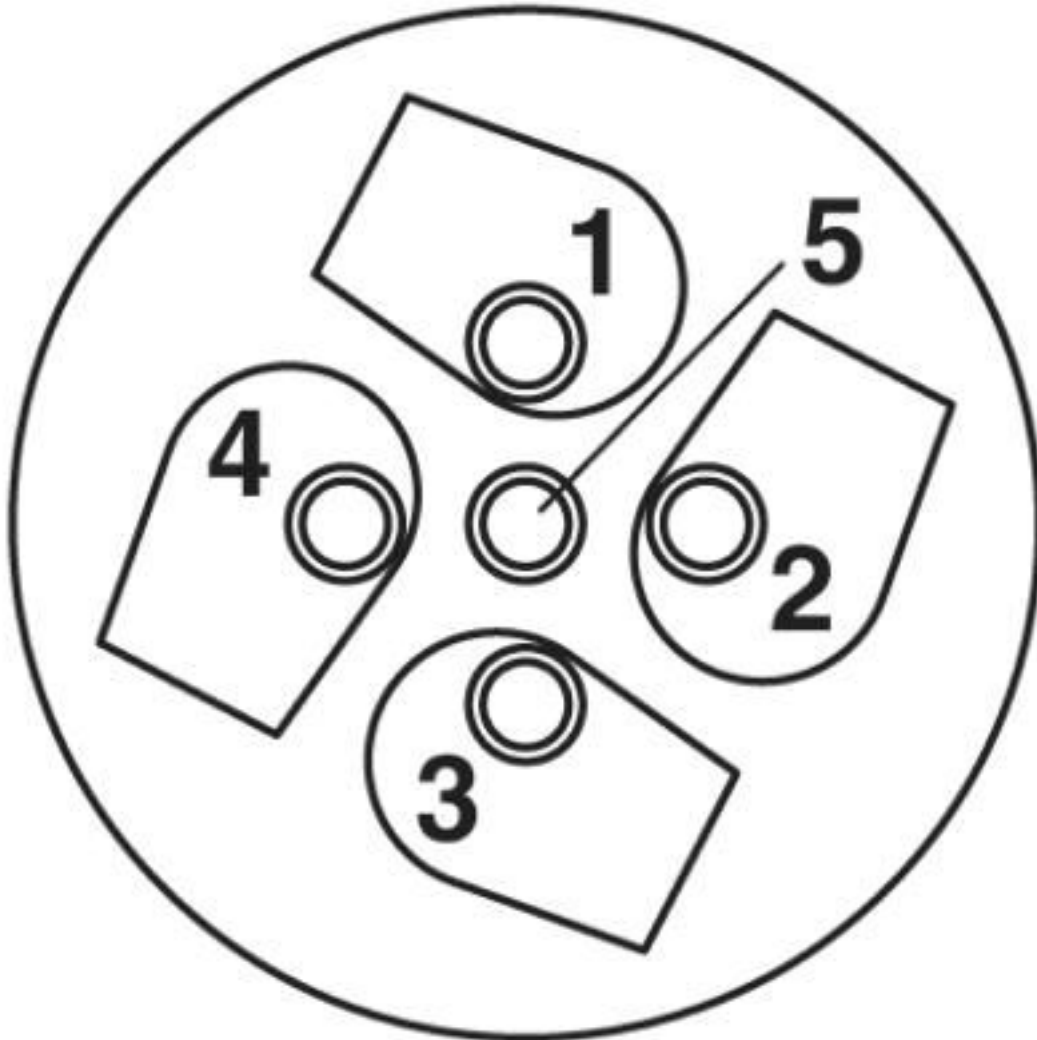

Cable connection side M12 (screw connection)

Connector - SACC-M12MR-5CON-PG 7 - 1662269

Schematic diagram

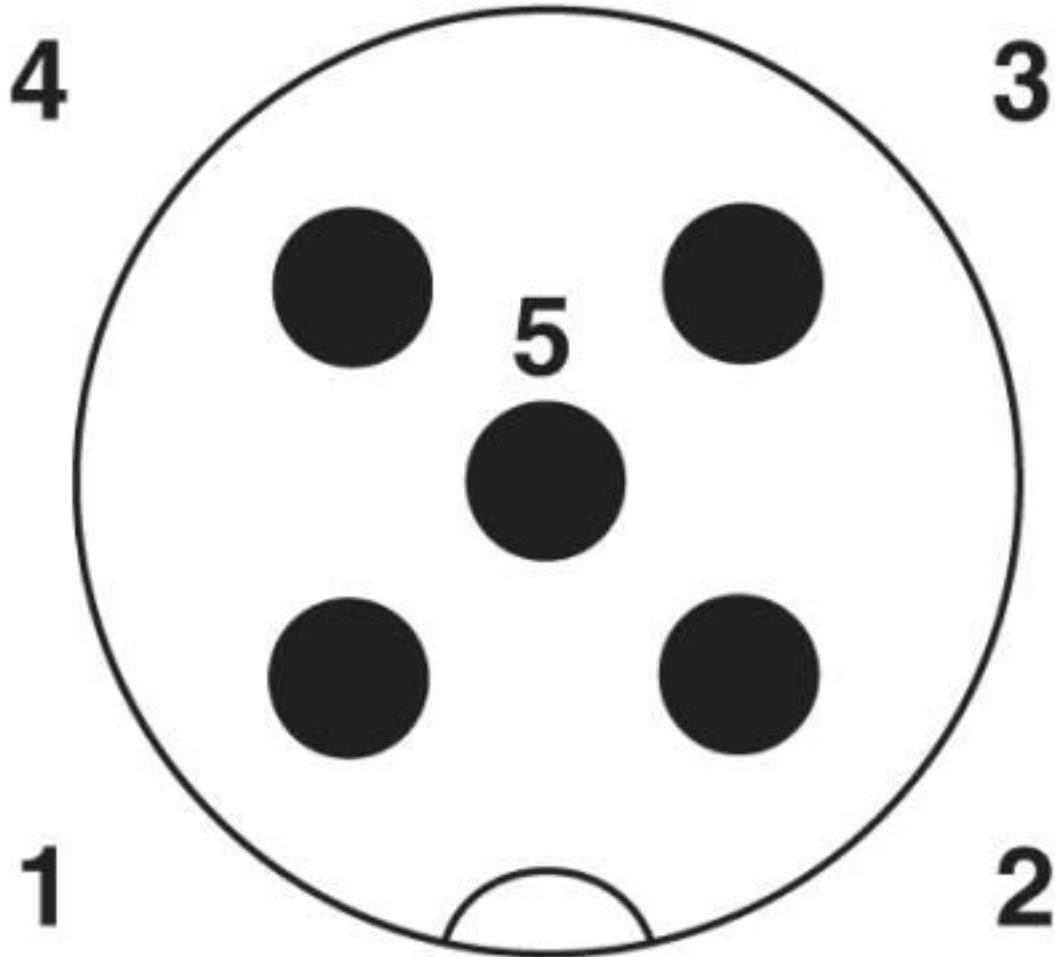

Pin assignment, plug M 12 (male side)

Classifications

eCl@ss

| | |
|---------------|----------|
| eCl@ss 10.0.1 | 27440102 |
| eCl@ss 4.0 | 27260700 |
| eCl@ss 4.1 | 27260700 |
| eCl@ss 5.0 | 27260700 |
| eCl@ss 5.1 | 27260700 |
| eCl@ss 6.0 | 27279200 |
| eCl@ss 7.0 | 27440104 |
| eCl@ss 8.0 | 27440104 |
| eCl@ss 9.0 | 27440102 |

Connector - SACC-M12MR-5CON-PG 7 - 1662269

Classifications

ETIM

| | |
|----------|----------|
| ETIM 2.0 | EC001121 |
| ETIM 3.0 | EC002062 |
| ETIM 4.0 | EC002062 |
| ETIM 5.0 | EC002062 |
| ETIM 6.0 | EC002062 |

UNSPSC

| | |
|---------------|----------|
| UNSPSC 6.01 | 31251501 |
| UNSPSC 7.0901 | 31251501 |
| UNSPSC 11 | 31251501 |
| UNSPSC 12.01 | 31251501 |
| UNSPSC 13.2 | 39121413 |
| UNSPSC 18.0 | 39121413 |
| UNSPSC 19.0 | 39121413 |
| UNSPSC 20.0 | 39121413 |
| UNSPSC 21.0 | 39121413 |

Approvals

Approvals

Approvals

UL Recognized / cUL Recognized / cULus Recognized

Ex Approvals

Approval details

| | | | |
|--------------------|-------------------------------------------------------------------------------------|-------------------------------------------------------------------------------------------------------------------------------------------------------|---------------|
| UL Recognized |  | http://database.ul.com/cgi-bin/XYV/template/LISEXT/1FRAME/index.htm | FILE E 221474 |
| Nominal voltage UN | 125 V | | |
| Nominal current IN | 4 A | | |

| | | | |
|--------------------|-------------------------------------------------------------------------------------|-------------------------------------------------------------------------------------------------------------------------------------------------------|---------------|
| cUL Recognized |  | http://database.ul.com/cgi-bin/XYV/template/LISEXT/1FRAME/index.htm | FILE E 221474 |
| Nominal voltage UN | 125 V | | |

Connector - SACC-M12MR-5CON-PG 7 - 1662269

Approvals

| | |
|--------------------------------|-----|
| Nominal current I _N | 4 A |
|--------------------------------|-----|

| | |
|------------------|--|
| cULus Recognized | |
|------------------|--|

Accessories

Accessories

Cable by the meter

Cable reel - SAC-5P-100,0-PUR/0,34 - 1501676



By the meter, Cable reel, PUR halogen-free, black-gray RAL 7021, 5-wire, color single wire: brown, white, blue, black, green-yellow, cable length: 100 m

Cable end sleeve

Ferrule - A 0,25- 5 - 3202465



Ferrule, length: 5 mm, color: silver

Crimping tool

Crimping pliers - CRIMPFOX 6H - 1212046



Crimping pliers, for ferrules without insulating collar according to DIN 46228 Part 1 and ferrules with insulating collar according to DIN 46228 Part 4, 0.14 mm² ... 6 mm², unlockable pressure lock, lateral entry

Protective cap

Connector - SACC-M12MR-5CON-PG 7 - 1662269

Accessories

Sealing cap - PROT-M12 FS-PA-CHAIN - 1430873

M12 sealing cap made of plastic with fixing band, for sensor cables, for free M12 plugs



Screwdriver tools

Adapter insert - TSD-M SAC-BIT ADAPTER - 1212600



Adapter bit for TSD-M...torque tools, E6.3-1/4" drive with 4 mm hexagon to accommodate SAC bits

Tool - SACC BIT M12-D20 - 1208445



Nut for assembling M12 connectors for assembly with a knurl diameter of 20 mm, for 4 mm hexagonal drive

Screwdriver - SZF 1-0,6X3,5 - 1204517



Actuation tool, for ST terminal blocks, also suitable for use as a bladed screwdriver, size: 0.6 x 3.5 x 100 mm, 2-component grip, with non-slip grip

Seal

Connector - SACC-M12-SET/2,5-3,5 - 1436505



Sensor/actuator connector, accessories, pressure screw and Pg7 seal, for unshielded M12 connector, cable diameter 2.5 mm - 3.5 mm

Torque tool

Connector - SACC-M12MR-5CON-PG 7 - 1662269

Accessories

Torque screwdriver - TSD 04 SAC - 1208429



Torque screwdriver, with preset torque of 0.4 Nm and 4 mm hexagonal drive for M12 connectors

Torque screwdriver - TSD-M 1,2NM - 1212224



Torque screw driver, accuracy as per EN ISO 6789 standard, adjustable from 0.3 - 1.2 Nm

Phoenix Contact 2020 © - all rights reserved
<http://www.phoenixcontact.com>

PHOENIX CONTACT GmbH & Co. KG
Flachsmarktstr. 8
32825 Blomberg
Germany
Tel. +49 5235 300
Fax +49 5235 3 41200
<http://www.phoenixcontact.com>

X-ON Electronics

Largest Supplier of Electrical and Electronic Components

Click to view similar products for [Circular Metric Connectors](#) category:

Click to view products by [Phoenix Contact](#) manufacturer:

Other Similar products are found below :

[600X518037X](#) [6STD15PCR99B70A](#) [8R4000A16M020](#) [8R5000A16M005](#) [1200910002](#) [1203580030](#) [1200910008](#) [1200910011](#) [1300140094](#)
[130203-0054](#) [1300140026](#) [1300150099](#) [RF-12S1N8A90DU](#) [1-3637-600-5205](#) [1612618](#) [21036836414](#) [8R4006A16M010](#) [1604232](#)
[1R3006A20M005](#) [RF-12P1N8A90DU](#) [41-40011](#) [42-00006](#) [42-01015](#) [4-22279-4](#) [4-22281-1](#) [4-22284-9](#) [43-00113](#) [43-01088](#) [43-01203](#) [41-](#)
[40013](#) [42-00008](#) [43-00343](#) [43-01026](#) [43-01162](#) [43-01173](#) [43-10000](#) [XS3P-M421-2](#) [600X518050X](#) [SACC-DSI-FS-5P-PG9-L180 SC](#)
[8R5006A16M020](#) [8R5006A16M005](#) [8R4000A16M010](#) [6-22279-3](#) [1605332](#) [N03FA03144](#) [1300140077](#) [43-16213](#) [43-01338](#) [XS2RD4265](#)
[XS2R-D426-1](#)