

Crimp contact - CK4,0-ED-6,00ST AG - 1663268

Please be informed that the data shown in this PDF Document is generated from our Online Catalog. Please find the complete data in the user's documentation. Our General Terms of Use for Downloads are valid (<http://phoenixcontact.com/download>)



Turned 4.0 crimp contact, individual male contact, core diameter 6.00 mm², silver-plated



Key Commercial Data

Packing unit	25 pc
Minimum order quantity	25 pc
GTIN	 4 017918 123079
GTIN	4017918123079

Technical data

Ambient conditions

Ambient temperature (operation)	-40 °C ... 125 °C
---------------------------------	-------------------

Mechanical characteristics

Conductor cross section	6 mm ² ... 6 mm ²
Connection cross section AWG	10
Stripping length of the individual wire	10 mm
Contact diameter	4 mm
Insertion/withdrawal cycles	≥ 500

General

Note	For HC-M-3 modules
Type	Individual male contact
Series	HC-M-03
Connection method	Crimp connection
Contact type	turned

Material data

Contact material	Copper alloy
------------------	--------------

Crimp contact - CK4,0-ED-6,00ST AG - 1663268

Technical data

Material data

Contact surface material	silver-plated
--------------------------	---------------

Environmental Product Compliance

REACH SVHC	Lead 7439-92-1
China RoHS	Environmentally Friendly Use Period = 50 years
	For details about hazardous substances go to tab "Downloads", Category "Manufacturer's declaration"

Drawings

Dimensional drawing

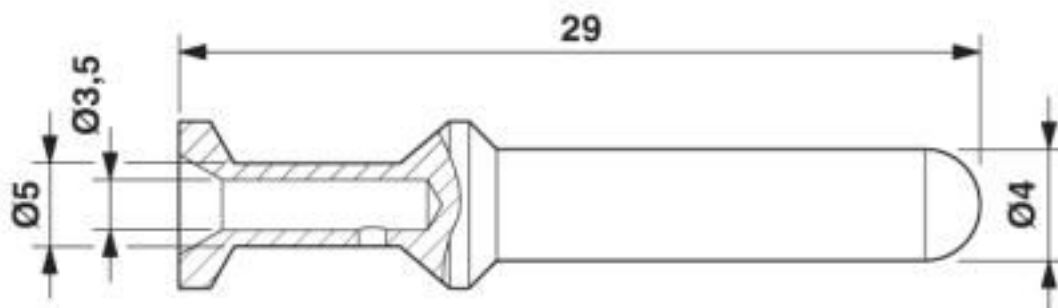

Classifications

eCl@ss

eCl@ss 10.0.1	27440204
eCl@ss 4.0	27140800
eCl@ss 4.1	27140800
eCl@ss 5.0	27143400
eCl@ss 5.1	27261200
eCl@ss 6.0	27261200
eCl@ss 7.0	27440204
eCl@ss 8.0	27440204
eCl@ss 9.0	27440204

ETIM

ETIM 2.0	EC000796
ETIM 3.0	EC000796
ETIM 4.0	EC000796
ETIM 5.0	EC000796
ETIM 6.0	EC000796
ETIM 7.0	EC000796

Crimp contact - CK4,0-ED-6,00ST AG - 1663268

Classifications

UNSPSC

UNSPSC 6.01	30211923
UNSPSC 7.0901	39121522
UNSPSC 11	39121522
UNSPSC 12.01	39121522
UNSPSC 13.2	39121522
UNSPSC 18.0	39121522
UNSPSC 19.0	39121522
UNSPSC 20.0	39121522
UNSPSC 21.0	39121522

Approvals

Approvals

Approvals

EAC / EAC

Ex Approvals

Approval details

EAC		RU C- DE.AI30.B.01102
-----	--	--------------------------

EAC		EAC-Zulassung
-----	--	---------------

Accessories

Accessories

Crimping tool

Crimping pliers - CRIMPFOX-4,0-ED-6,00 - 1205859



Crimping pliers, for CK 4,0... contacts, for 4.0 - 6.0 mm² conductor cross sections

Crimp contact - CK4,0-ED-6,00ST AG - 1663268

Accessories

Universal tools

Contact removal tool - UNIFOX RT-CK 4.0 - 1072064



Contact removal tool, for rotated CK-4,0-... contacts

Additional products

Crimp contact - CK4,0-ED-6,00BU AG - 1663307



Turned 4.0 crimp contact, individual female contact, core diameter 6.00 mm², silver-plated

Phoenix Contact 2020 © - all rights reserved
<http://www.phoenixcontact.com>

PHOENIX CONTACT GmbH & Co. KG
Flachsmarktstr. 8
32825 Blomberg
Germany
Tel. +49 5235 300
Fax +49 5235 3 41200
<http://www.phoenixcontact.com>

X-ON Electronics

Largest Supplier of Electrical and Electronic Components

Click to view similar products for [Heavy Duty Power Connectors](#) category:

Click to view products by [Phoenix Contact](#) manufacturer:

Other Similar products are found below :

[647757-1](#) [6643411-1](#) [6646058-2](#) [6646137-1](#) [6646138-1](#) [6646479-1](#) [6646608-1](#) [6646786-1](#) [6646940-1](#) [6651091-1](#) [6651525-1](#) [6651529-1](#)
[6651788-1](#) [696475-1](#) [702-32-01109](#) [703-25-02205](#) [73000005059](#) [73000005642](#) [73080255059](#) [73080965046](#) [765-15-0080A](#) [765-16-0080B](#)
[765-18-0080D](#) [829992-1](#) [902-77-02113](#) [PS00/A0620/6300](#) [PS25/A0420/63](#) [129-1J](#) [1409400](#) [AN0024023](#) [E6374G1](#) [e6389g2](#) [157-43GW8](#)
[MS3117-14AC](#) [1643543-1](#) [1650540-1](#) [1651811-2](#) [1766260-1](#) [1766282-1](#) [1766966-1](#) [1791340000](#) [NLDFT-3-BL-L-S120-M40A](#) [NLDFT-N-](#)
[W-L-C240-M40B](#) [NLS-2-R-C240-M40B](#) [NLS-N-W-C240-M40B](#) [NPS-3-BL-T6](#) [1986615-1](#) [2-1589900-8](#) [2199314-1](#) [KA8102](#)