

Pneumatic contact - HC-M-PN3-4,00-ST - 1663501

Please be informed that the data shown in this PDF Document is generated from our Online Catalog. Please find the complete data in the user's documentation. Our General Terms of Use for Downloads are valid (<http://phoenixcontact.com/download>)



Pneumatic pin, for HC-M-PN3 module, internal hose diameter of 4.0 mm



Key Commercial Data

Packing unit	10 pc
GTIN	 4 017918 123314
GTIN	4017918123314

Technical data

Ambient conditions

Ambient temperature (operation)	-40 °C ... 80 °C
---------------------------------	------------------

Mechanical characteristics

Contact diameter	5.2 mm
Operating pressure	8.00 bar
Internal diameter of pressure hose connection	4 mm
Insertion/withdrawal cycles	≥ 500

General

Series	HC-M-03-PN
Integrated valve	No
Color	black
Connection method	Hose connection

Material data

Contact material	Delrin acetal
------------------	---------------

Environmental Product Compliance

China RoHS	Environmentally friendly use period: unlimited = EFUP-e
------------	---

Pneumatic contact - HC-M-PN3-4,00-ST - 1663501

Technical data

Environmental Product Compliance

	No hazardous substances above threshold values
--	--

Drawings

Dimensional drawing

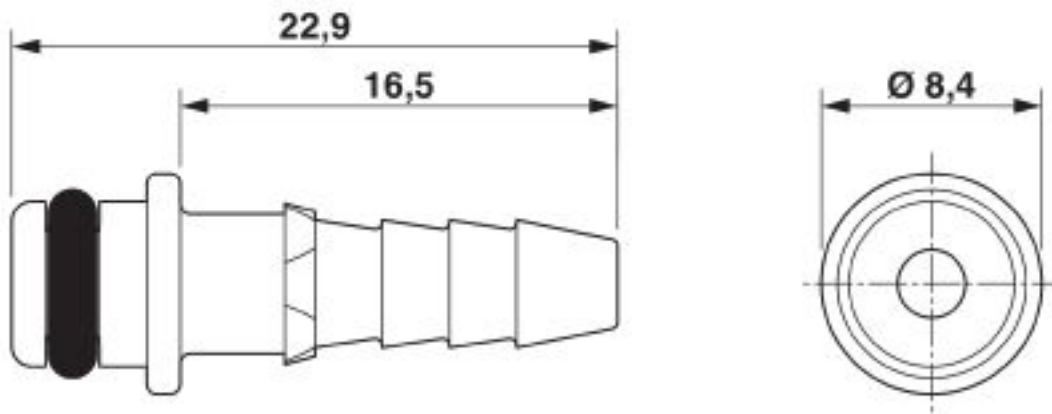

Classifications

eCl@ss

eCl@ss 10.0.1	27440192
eCl@ss 4.0	27140800
eCl@ss 4.1	27140800
eCl@ss 5.0	27143400
eCl@ss 5.1	27261200
eCl@ss 6.0	27261200
eCl@ss 7.0	27440205
eCl@ss 8.0	27440205
eCl@ss 9.0	27440192

ETIM

ETIM 2.0	EC000796
ETIM 3.0	EC000796
ETIM 4.0	EC000796
ETIM 5.0	EC000438
ETIM 6.0	EC000438
ETIM 7.0	EC000438

UNSPSC

UNSPSC 6.01	30211808
-------------	----------

Pneumatic contact - HC-M-PN3-4,00-ST - 1663501

Classifications

UNSPSC

UNSPSC 7.0901	39121408
UNSPSC 11	39121408
UNSPSC 12.01	39121408
UNSPSC 13.2	39121522
UNSPSC 18.0	39121421
UNSPSC 19.0	39121421
UNSPSC 20.0	39121421
UNSPSC 21.0	39121421

Approvals

Approvals

Approvals

EAC

Ex Approvals

Approval details

EAC		RU C- DE.AI30.B.01102
-----	--	--------------------------

Accessories

Accessories

Pneumatic insert, modular

Contact insert module - HC-M-03-PN-M-F - 1417433



Contact insert module, number of positions: 3, Socket, Pin, application: Pneumatics, for internal hose diameter of 1.6 / 3 / 4 mm

Pneumatic contact - HC-M-PN3-4,00-ST - 1663501

Accessories

Gasket - HC-M-PN3-ERSORI - 1408203



Replacement O-ring for HC-M-PN3...ST pneumatic pin contacts

Additional products

Pneumatic contact - HC-M-PN3-4,00-BU - 1663530



Pneumatic socket, for HC-M-PN3 module, internal hose diameter of 4.0 mm

Phoenix Contact 2020 © - all rights reserved
<http://www.phoenixcontact.com>

PHOENIX CONTACT GmbH & Co. KG
Flachsmarktstr. 8
32825 Blomberg
Germany
Tel. +49 5235 300
Fax +49 5235 3 41200
<http://www.phoenixcontact.com>

X-ON Electronics

Largest Supplier of Electrical and Electronic Components

Click to view similar products for [Heavy Duty Power Connectors](#) category:

Click to view products by [Phoenix Contact](#) manufacturer:

Other Similar products are found below :

[647757-1](#) [6643411-1](#) [6646058-2](#) [6646137-1](#) [6646138-1](#) [6646479-1](#) [6646608-1](#) [6646786-1](#) [6646940-1](#) [6651091-1](#) [6651525-1](#) [6651529-1](#)
[6651788-1](#) [696475-1](#) [702-32-01109](#) [703-25-02205](#) [73000005059](#) [73000005642](#) [73080965046](#) [765-15-0080A](#) [765-16-0080B](#) [765-18-0080D](#)
[829992-1](#) [902-77-02113](#) [PS00/A0620/6300](#) [129-1J](#) [1409400](#) [AN0024023](#) [E6374G1](#) [e6389g2](#) [157-43GW8](#) [MS3117-14AC](#) [1643543-1](#)
[1650540-1](#) [1651811-2](#) [1766260-1](#) [1766282-1](#) [1766966-1](#) [1791340000](#) [NLDFT-3-BL-L-S120-M40A](#) [NLDFT-N-W-L-C240-M40B](#) [NLS-2-R-](#)
[C240-M40B](#) [NLS-N-W-C240-M40B](#) [NPS-3-BL-T6](#) [1986615-1](#) [2-1589900-8](#) [2199314-1](#) [KA8102](#) [9300480317](#) [SBS50BRN#6](#)