

## Sensor/actuator cable - SAC-4P- 1,5-PUR/M12FR-3L - 1668289

Please be informed that the data shown in this PDF Document is generated from our Online Catalog. Please find the complete data in the user's documentation. Our General Terms of Use for Downloads are valid (<http://phoenixcontact.com/download>)



Sensor/actuator cable, 4-position, PUR halogen-free, black-gray RAL 7021, free cable end, on Socket angled M12, coding: A, with 3 LEDs, cable length: 1.5 m

### Your advantages

- ✓ Easy and safe: 100% electrically tested plug-in components
- ✓ Our standard: robust halogen-free PUR cable
- ✓ Convenient: increased machine availability thanks to quick and easy diagnostics

RoHS

### Key Commercial Data

|              |   |
|--------------|---|
| Packing unit | 1 pc  |
| GTIN         | <br>4 017918 137137 |
| GTIN         | 4017918137137   |
| Sales Key    | 02  |

### Technical data

#### Dimensions

|  |       |
|--|-------|
| Length of cable                            | 1.5 m |
| Stripping length of the free conductor end | 50 mm |

#### Ambient conditions

|                                 |                                  |
|---------------------------------|----------------------------------|
| Ambient temperature (operation) | -25 °C ... 90 °C (Plug / socket) |
| Degree of protection            | IP65                             |
|                                 | IP67                             |
|                                 | IP68                             |

#### General

|                       |         |
|-----------------------|---------|
| Rated current at 40°C | 4 A     |
| Rated voltage         | 24 V DC |
| Number of positions   | 4       |

# Sensor/actuator cable - SAC-4P- 1,5-PUR/M12FR-3L - 1668289

## Technical data

### General

|                              |                               |
|------------------------------|-------------------------------|
| Color handle area            | transparent                   |
| Insulation resistance        | ≥ 100 MΩ                      |
| Coding                       | A - standard                  |
| Standards/regulations        | M12 connector IEC 61076-2-101 |
| Status display               | 3 LEDs                        |
| Protective circuit/component | unwired                       |
| Overvoltage category         | II                            |
| Degree of pollution          | 3                             |
| Insertion/withdrawal cycles  | ≥ 100                         |
| Torque                       | 0.4 Nm (M12 connector)        |

### Material

|  |   |
|--|---|
| Flammability rating according to UL 94 | HB  |
| Contact material                       | CuSn  |
| Contact surface material               | Ni/Au                                       |
| Contact carrier material               | TPU GF                                      |
| Material of grip body                  | TPU, hardly inflammable, self-extinguishing |
| Material, knurls                       | Zinc die-cast, nickel-plated                |
| Sealing material                       | NBR   |

### Standards and Regulations

|  |                               |
|--|-------------------------------|
| Standards/specifications               | M12 connector IEC 61076-2-101 |
| Flammability rating according to UL 94 | HB                            |

### Cable

|   |                            |
|---|----------------------------|
| Cable type                                    | PUR halogen-free black     |
| Cable type (abbreviation)                     | PUR                        |
| Cable abbreviation                            | Li9Y11Y-HF                 |
| UL AWM style                                  | 20549 / 10493 (80°C/300 V) |
| Conductor cross section                       | 4x 0.34 mm <sup>2</sup>    |
| AWG signal line                               | 22                         |
| Conductor structure signal line               | 42x 0.10 mm                |
| Core diameter including insulation            | 1.27 mm ±0.02 mm           |
| Thickness, insulation                         | ≥ 0.21 mm                  |
| Wire colors                                   | brown, white, blue, black  |
| Overall twist                                 | 4 wires, twisted           |
| External sheath, color                        | black-gray RAL 7021        |
| Outer sheath thickness                        | approx. 0.5 mm             |
| External cable diameter D                     | 4.2 mm ±0.15 mm            |
| Minimum bending radius, fixed installation    | 5 x D                      |
| Minimum bending radius, flexible installation | 10 x D                     |
| Number of bending cycles                      | 10000000                   |

## Sensor/actuator cable - SAC-4P- 1,5-PUR/M12FR-3L - 1668289

### Technical data

#### Cable

|   |   |
|---|---|
| Minimum bending radius, drag chain applications | 10 x D  |
| Traversing path                                 | 10 m  |
| Traversing rate                                 | 3 m/s   |
| Acceleration                                    | 10 m/s <sup>2</sup>   |
| Cable weight                                    | 30 kg/km  |
| Outer sheath, material                          | PUR   |
| Material conductor insulation                   | PP  |
| Conductor material                              | Bare Cu litz wires  |
| Insulation resistance                           | ≥ 1 GΩ*km   |
| Conductor resistance                            | ≤ 58 Ω/km   |
| Nominal voltage, cable                          | ≤ 300 V   |
| Test voltage, cable                             | ≥ 3000 V  |
| Special properties                              | Flexible cable conduit capable                                      |
|   | Silicone-free   |
|   | Free of substances which would hinder coating with paint or varnish |
|   | flexible  |
| Flame resistance                                | in accordance with UL 758/1581 FT2                                  |
|   | DIN EN 60332-2-2 (20 s)   |
| Halogen-free                                    | in accordance with DIN VDE 0472 part 815                            |
|   | in accordance with DIN EN 50267-2-1                                 |
| Resistance to oil                               | in accordance with DIN EN 60811-2-1                                 |
| Other resistance                                | Highly resistant to acids, alkaline solutions and solvents          |
|   | hydrolysis and microbe resistant                                    |
|   | partly UV-resistant in accordance with DIN EN ISO 4892-2-A          |
|   | Low adhesion  |
|   | abrasion-resistant  |
| Ambient temperature (operation)                 | -40 °C ... 80 °C (cable, fixed installation)                        |
|   | -25 °C ... 80 °C (cable, flexible installation)                     |

#### Environmental Product Compliance

|            |   |
|------------|---|
| China RoHS | Environmentally friendly use period: unlimited = EFUP-e |
|            | No hazardous substances above threshold values          |

#### Drawings

## Sensor/actuator cable - SAC-4P- 1,5-PUR/M12FR-3L - 1668289

Dimensional drawing

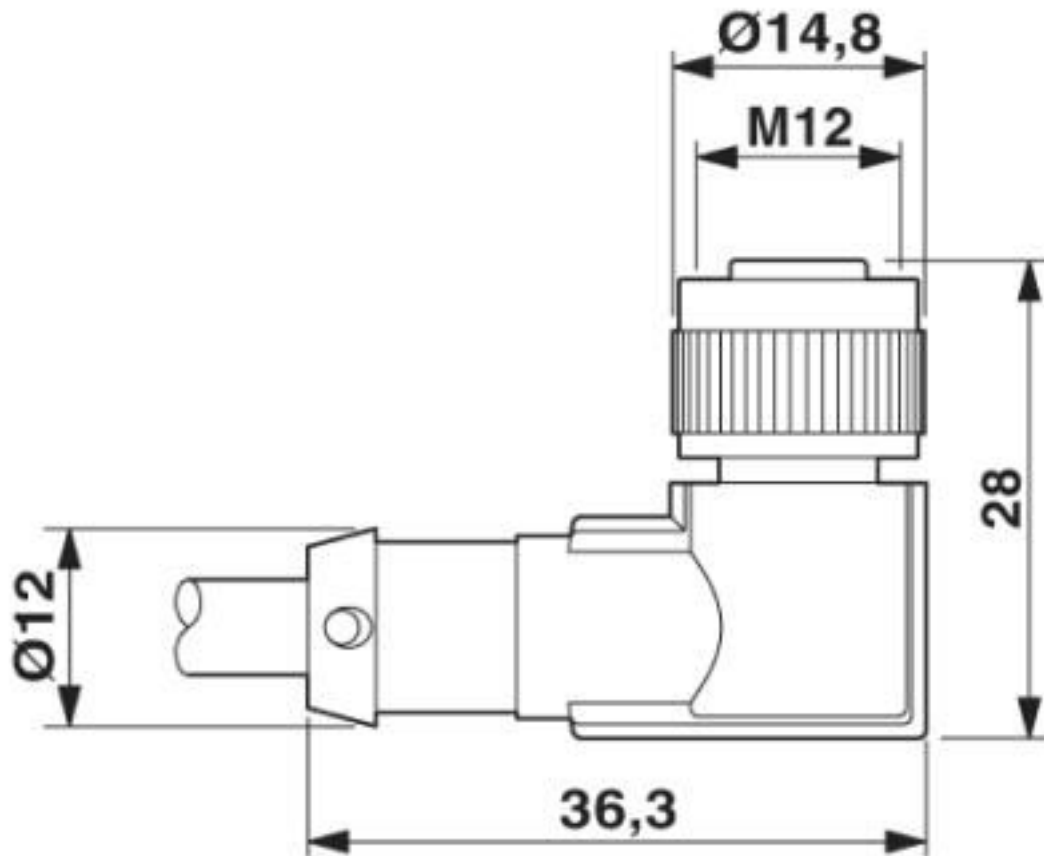

Socket M12 x 1, angled, with LED

## Sensor/actuator cable - SAC-4P- 1,5-PUR/M12FR-3L - 1668289

Circuit diagram

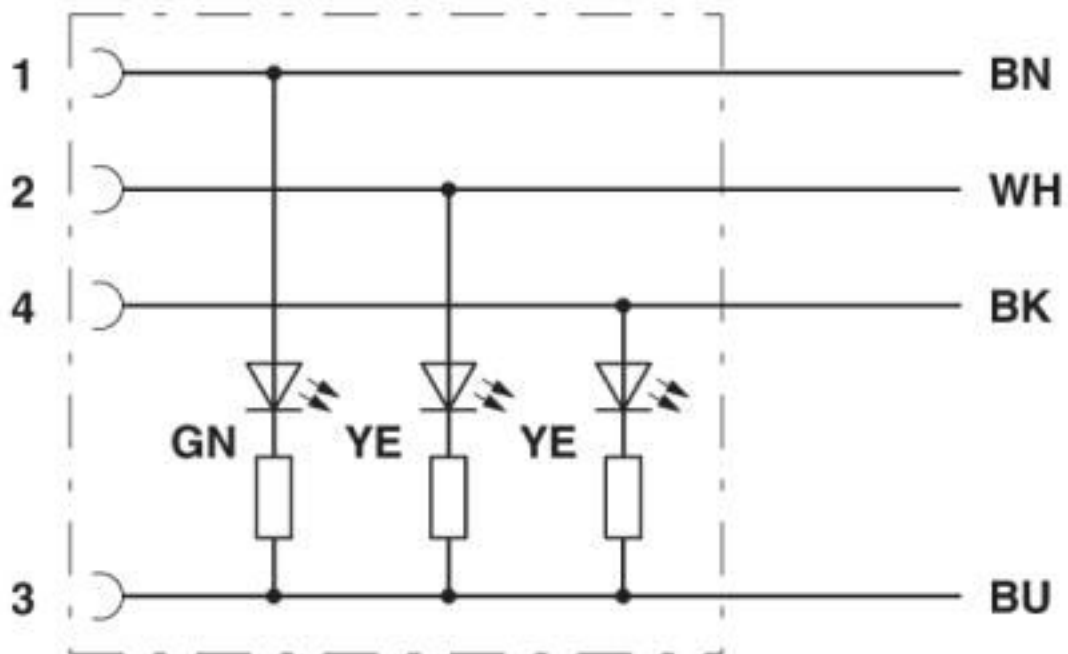

Contact assignment of M12 sockets with LED

## Sensor/actuator cable - SAC-4P- 1,5-PUR/M12FR-3L - 1668289

Schematic diagram

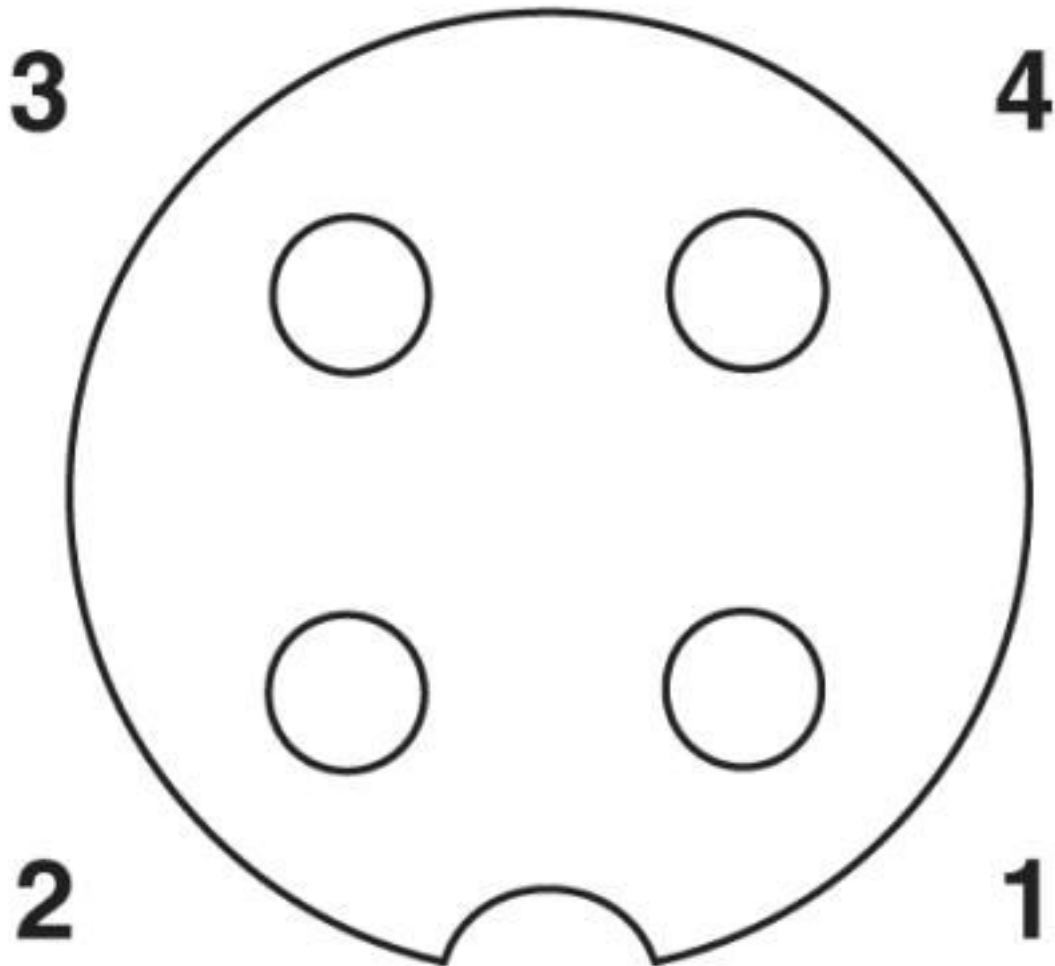

Pin assignment M12 socket, 4-pos., A-coded, view female side

# Sensor/actuator cable - SAC-4P- 1,5-PUR/M12FR-3L - 1668289

Cable cross section

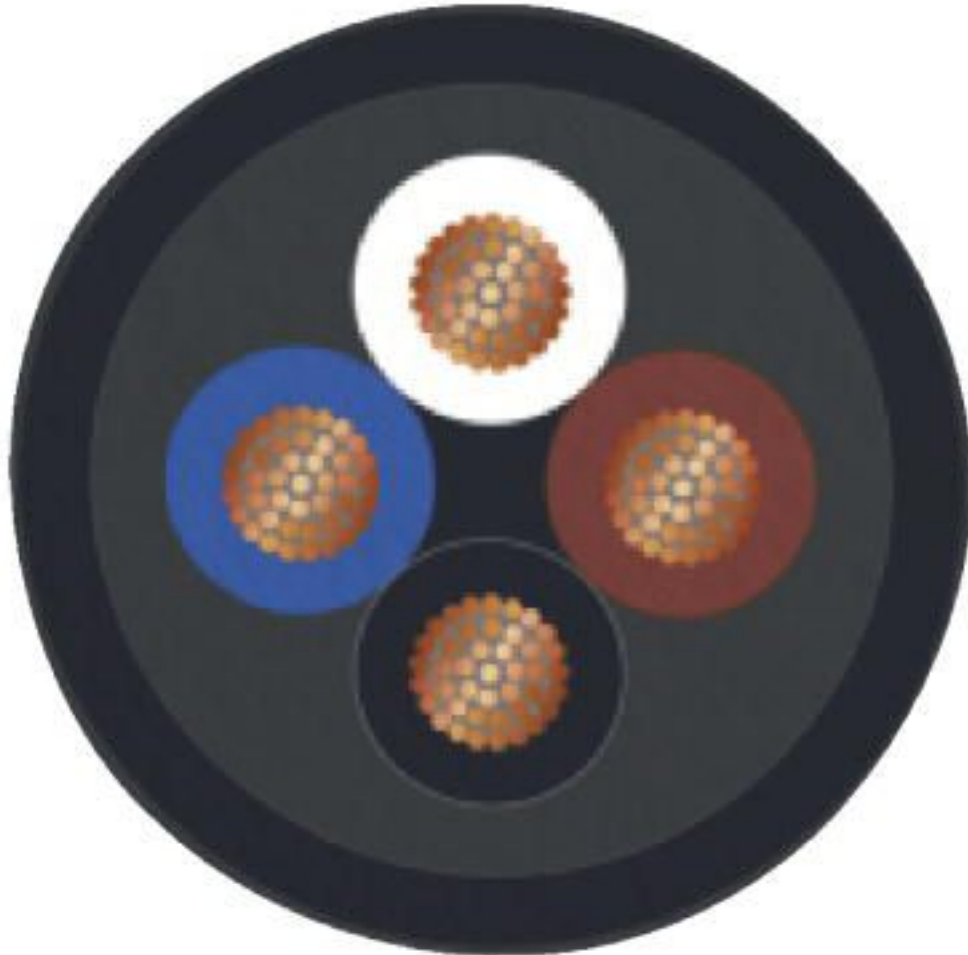

PUR halogen-free black [PUR]

## Classifications

eCl@ss

|               |          |
|---------------|----------|
| eCl@ss 10.0.1 | 27060311 |
| eCl@ss 4.0    | 27060300 |
| eCl@ss 4.1    | 27060300 |
| eCl@ss 5.0    | 27061800 |
| eCl@ss 5.1    | 27061800 |
| eCl@ss 6.0    | 27279200 |
| eCl@ss 7.0    | 27279218 |
| eCl@ss 8.0    | 27279218 |
| eCl@ss 9.0    | 27060311 |

# Sensor/actuator cable - SAC-4P- 1,5-PUR/M12FR-3L - 1668289

## Classifications

### ETIM

|          |          |
|----------|----------|
| ETIM 2.0 | EC000830 |
| ETIM 3.0 | EC001855 |
| ETIM 4.0 | EC001855 |
| ETIM 5.0 | EC001855 |
| ETIM 6.0 | EC001855 |
| ETIM 7.0 | EC001855 |

### UNSPSC

|               |          |
|---------------|----------|
| UNSPSC 6.01   | 31251501 |
| UNSPSC 7.0901 | 31251501 |
| UNSPSC 11     | 31251501 |
| UNSPSC 12.01  | 31251501 |
| UNSPSC 13.2   | 31251501 |
| UNSPSC 19.0   | 31251501 |
| UNSPSC 20.0   | 31251501 |
| UNSPSC 21.0   | 31251501 |

## Approvals

### Approvals

#### Approvals

UL Listed / cUL Listed / EAC-RoHS / EAC / cULus Listed

#### Ex Approvals

### Approval details

|                    |   |   |               |
|--------------------|---|---|---------------|
| UL Listed          |  | <a href="http://database.ul.com/cgi-bin/XYV/template/LISEXT/1FRAME/index.htm">http://database.ul.com/cgi-bin/XYV/template/LISEXT/1FRAME/index.htm</a> | FILE E 221474 |
| Nominal voltage UN | 24 V  |   |               |
| Nominal current IN | 4 A   |   |               |

|                    |   |   |               |
|--------------------|---|---|---------------|
| cUL Listed         |  | <a href="http://database.ul.com/cgi-bin/XYV/template/LISEXT/1FRAME/index.htm">http://database.ul.com/cgi-bin/XYV/template/LISEXT/1FRAME/index.htm</a> | FILE E 221474 |
| Nominal voltage UN | 24 V  |   |               |



# Sensor/actuator cable - SAC-4P- 1,5-PUR/M12FR-3L - 1668289

## Approvals

|                                |     |
|--------------------------------|-----|
| Nominal current I <sub>N</sub> | 4 A |
|--------------------------------|-----|

|          |  |                          |
|----------|--|--------------------------|
| EAC-RoHS |  | RU D-<br>DE.HB35.B.00387 |
|----------|--|--------------------------|

|     |  |               |
|-----|--|---------------|
| EAC |  | EAC-Zulassung |
|-----|--|---------------|

|              |  |  |
|--------------|--|--|
| cULus Listed |  |  |
|--------------|--|--|

## Accessories

### Accessories

#### Conductor marking

Insert label - PABA WH/23 - 1013779



Insert label, Strip, white, unlabeled, can be labeled with: CMS-P1-PLOTTER, mounting type: thread on, cable diameter range: 1.5 ... 35 mm, lettering field size: 23 x 4 mm, Number of individual labels: 20

Insert label - PABA YE/23 - 1013782



Insert label, Strip, yellow, unlabeled, can be labeled with: CMS-P1-PLOTTER, mounting type: thread on, cable diameter range: 1.5 ... 35 mm, lettering field size: 23 x 4 mm, Number of individual labels: 20

#### Corrugated pipe

Protective hose - WP-PA HF 13,0 BK - 3240681



Polyamide protective hose, inflammability class V0, UV resistant

## Sensor/actuator cable - SAC-4P- 1,5-PUR/M12FR-3L - 1668289

### Accessories

Protective hose - WP-PA HF-HB 13,0 BK - 3240839



Polyamide protective hose, inflammability class HB, UV resistant

---

### Cutting tools

Diagonal cutter - CUTFOX-S VDE - 1212207



Diagonal cutter for hard (piano wire) and soft wires, VDE 1000 V AC/1500 V DC tested

---

### Marker pen

Marker pen - B-STIFT - 1051993



Marker pen, for manual labeling of unprinted Zack strips, smear-proof and waterproof, line thickness 0.5 mm

---

### Plug for cable screw gland

Screw plug - PROT-M12 MS-PA-CHAIN - 1430899



M12 sealing cap with fixing band, for sensor cables, for free M12 sockets

---

### Safety locking

Locking clip - SAC-M12-EXCLIP-F - 1558991



Locking clip for the socket side of sensor/actuator cables with M12 connector and M12 connectors for assembly, for knurl diameter: 15 mm or for Allen key with a wrench size of 14 mm, prevents the disconnection of plug-in connections without tools

## Sensor/actuator cable - SAC-4P- 1,5-PUR/M12FR-3L - 1668289

### Accessories

#### Screwdriver tools

Adapter insert - TSD-M SAC-BIT ADAPTER - 1212600



Adapter bit for TSD-M...torque tools, E6.3-1/4" drive with 4 mm hexagon to accommodate SAC bits

---

Tool - SAC BIT M12-D15 - 1208432



Nut for assembling sensor/actuator cables with M12 connector and M12 connectors for assembly, with a knurl diameter of 15 mm, for 4 mm hexagonal drive

---

#### Stripping tool

Stripping tool - WIREFOX SAC-1 - 1212757



Stripping pliers, for halogen-free sensor/actuator cables (SAC cables), with PUR and PVC insulation, from Ø of 3.2 to 4.4 mm, any stripping length

---

Stripping tool - WIREFOX SAC - 1212623



Stripping pliers, for halogen-free sensor/actuator cables (SAC cables), with PUR and PVC insulation, from Ø of 4.4 to 7 mm, any stripping length

---

Stripping tool - WIREFOX 10 - 1212150



Stripping tool, for cables and conductors from 0.02 - 10 mm<sup>2</sup>, self-adjusting, stripping length of up to 18 mm, cutting capacity of up to 10 mm<sup>2</sup> stranded/1.5 mm<sup>2</sup> solid, replaceable stripping blade

---

#### Torque tool

## Sensor/actuator cable - SAC-4P- 1,5-PUR/M12FR-3L - 1668289

### Accessories

Torque screwdriver - TSD 04 SAC - 1208429



Torque screwdriver, with preset torque of 0.4 Nm and 4 mm hexagonal drive for M12 connectors

---

Torque screwdriver - TSD-M 1,2NM - 1212224



Torque screw driver, accuracy as per EN ISO 6789 standard, adjustable from 0.3 - 1.2 Nm

---

Protective hose adapter - WP-CTA POM 13,0 BK - 1422884



Protective hose adapter, for corrugated hoses with a nominal size of 13 (10 x 13), corrugated in parallel

---

Phoenix Contact 2020 © - all rights reserved  
<http://www.phoenixcontact.com>

PHOENIX CONTACT GmbH & Co. KG  
Flachsmarktstr. 8  
32825 Blomberg  
Germany  
Tel. +49 5235 300  
Fax +49 5235 3 41200  
<http://www.phoenixcontact.com>

## X-ON Electronics

Largest Supplier of Electrical and Electronic Components

*Click to view similar products for [Sensor Cables / Actuator Cables](#) category:*

*Click to view products by [Phoenix Contact](#) manufacturer:*

Other Similar products are found below :

[60963](#) [60964](#) [M83513/19-F01CP](#) [703000D02F2002](#) [703000D02F300](#) [703001D02F0602](#) [703001D02F300](#) [704000D02F120](#) [773032K02F030](#)  
[802027107404-1](#) [804001A09M150](#) [805001A09M0502](#) [84914-0235](#) [84914-0237](#) [885030A09M020](#) [1200651332](#) [1200651713](#) [1200660844](#)  
[1200660845](#) [1200661173](#) [1200680071](#) [1200720053](#) [1200720081](#) [1200720099](#) [1200720217](#) [1200800231](#) [1200860125](#) [1200870123](#)  
[1200980102](#) [1200650267](#) [1200650298](#) [1200660183](#) [1200660782](#) [1200660849](#) [1200661295](#) [1200661297](#) [1200661342](#) [1200661343](#)  
[1200670080](#) [1200670220](#) [1200680331](#) [1200720252](#) [1200730184](#) [1200860344](#) [1200870359](#) [1200870643](#) [1200980008](#) [1200980031](#)  
[1210502211](#) [1210400542](#)