

Feed-through header - DFK-PC 6-16/ 8-GU-10,16 - 1701676

Please be informed that the data shown in this PDF Document is generated from our Online Catalog. Please find the complete data in the user's documentation. Our General Terms of Use for Downloads are valid (<http://phoenixcontact.com/download>)

Feed-through header, nominal current: 76 A, rated voltage (III/2): 1000 V, nominal cross section: 16 mm², number of positions: 8, pitch: 10.16 mm, color: green, contact surface: Silver, mounting: Wave soldering, pin layout: Linear pinning, solder pin [P]: 4.1 mm



The figure shows a 5-pos. version of the product

Your advantages

- Well-known mounting principle allows worldwide use
- Flange system enables secure fixing to the housing panel by means of tool-free snap-in locking or screws



Key Commercial Data

Packing unit	10 pc
GTIN	 4 046356 030748
GTIN	4046356030748

Technical data

Item properties

Brief article description	Feed-through header
Plug-in system	POWER COMBICON 16
Type of contact	Male connector
Range of articles	DFK-PC 6-16/..-GU
Pitch	10.16 mm
Number of positions	8
Mounting type	Wave soldering
Pin layout	Linear pinning
Locking	without
Number of levels	1
Number of connections	8
Number of potentials	8

Feed-through header - DFK-PC 6-16/ 8-GU-10,16 - 1701676

Technical data

Electrical parameters

Nominal current	76 A
Nom. voltage	1000 V
Rated voltage	1000 V
Rated voltage (III/2)	1000 V
Rated voltage (II/2)	1000 V
Rated surge voltage (III/3)	8 kV
Rated surge voltage (III/2)	8 kV
Rated surge voltage (II/2)	6 kV

Material data - contact

Note	WEEE/RoHS-compliant, free of whiskers according to IEC 60068-2-82/ JEDEC JESD 201
Contact material	Cu alloy
Surface characteristics	Selective coating
Metal surface contact area (top layer)	Silver (4 - 8 µm Ag)
Metal surface contact area (middle layer)	Nickel (2 - 4 µm Ni),
Metal surface soldering area (top layer)	Silver (4 - 8 µm Ag)
Metal surface soldering area (middle layer)	Nickel (2 - 4 µm Ni)

Material data - housing

Housing color	green (6021)
Insulating material	PA
Insulating material group	I
CTI according to IEC 60112	600
Flammability rating according to UL 94	V0
Glow wire flammability index GWFI according to EN 60695-2-12	850
Glow wire ignition temperature GWIT according to EN 60695-2-13	775
Temperature for the ball pressure test according to EN 60695-10-2	125 °C

Dimensions for the product

Length [l]	34 mm
Width [w]	100.72 mm
Height [h]	20.3 mm
Pitch	10.16 mm
Height (without solder pin)	19 mm
Solder pin [P]	4.1 mm
Pin spacing	10.16 mm
Pin dimensions	1 x 1.2 mm

Dimensions for PCB design

Hole diameter	1.7 mm
Pin spacing	10.16 mm

Packaging information

Feed-through header - DFK-PC 6-16/ 8-GU-10,16 - 1701676

Technical data

Packaging information

Type of packaging	packed in cardboard
Pieces per package	10
Denomination packing units	Pcs.

Standards and Regulations

Connection in acc. with standard	EN-VDE
	CUL
Flammability rating according to UL 94	V0

Environmental Product Compliance

China RoHS	Environmentally friendly use period: unlimited = EFUP-e
	No hazardous substances above threshold values

Drawings

Feed-through header - DFK-PC 6-16/ 8-GU-10,16 - 1701676

Drilling diagram

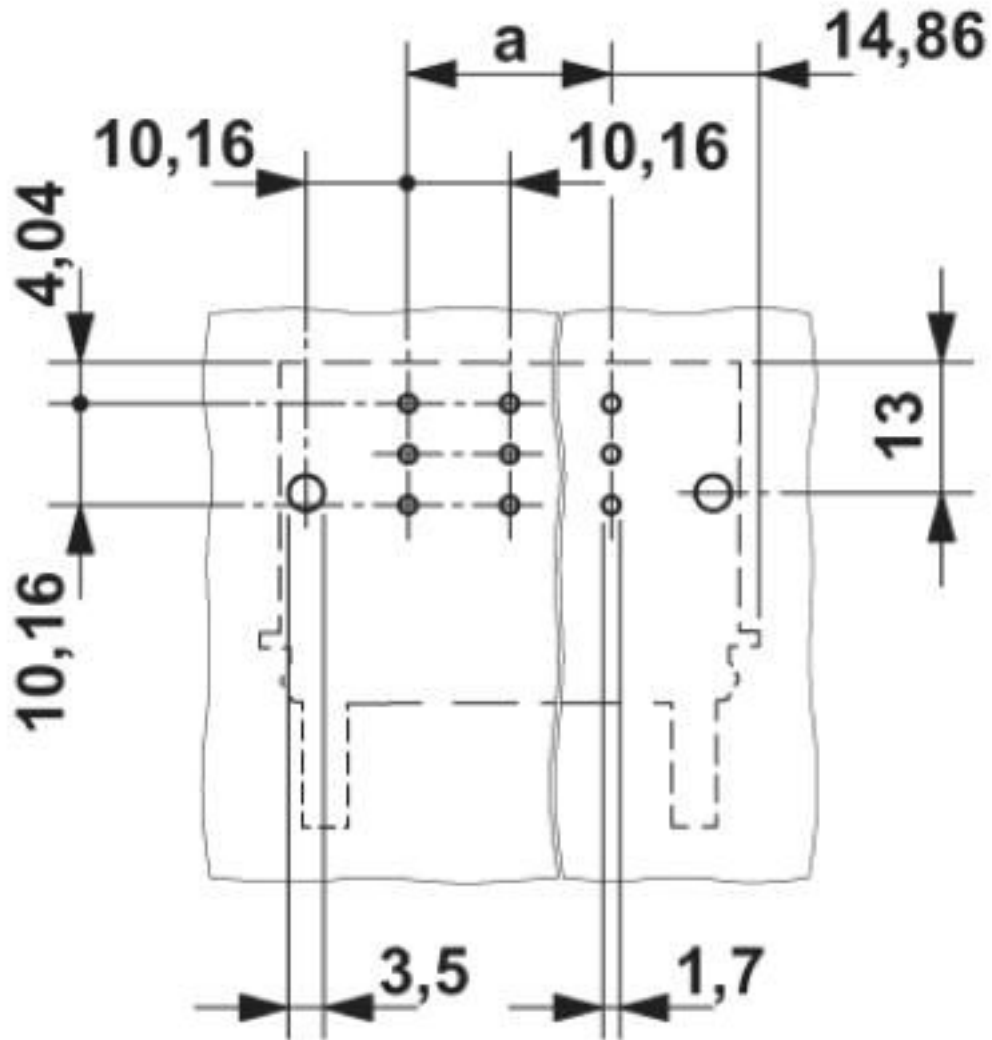

Feed-through header - DFK-PC 6-16/ 8-GU-10,16 - 1701676

Dimensional drawing

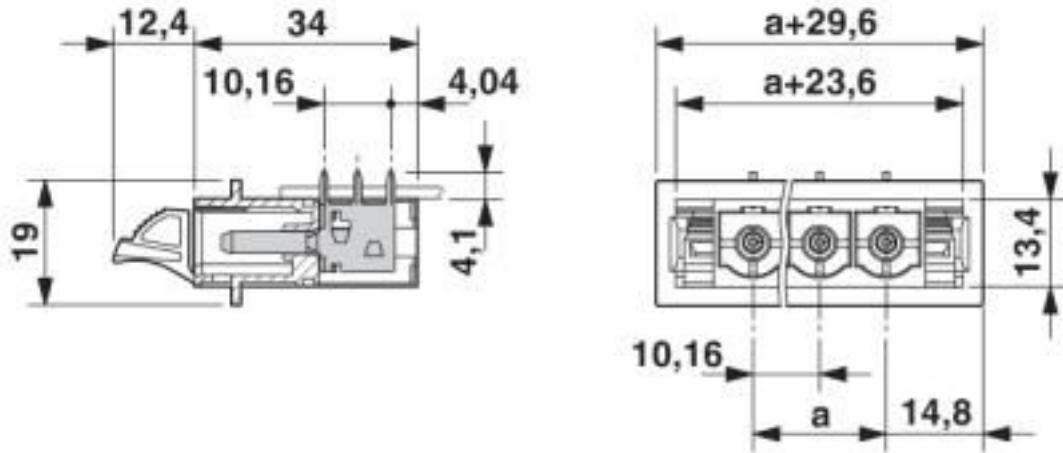

Dimensional drawing

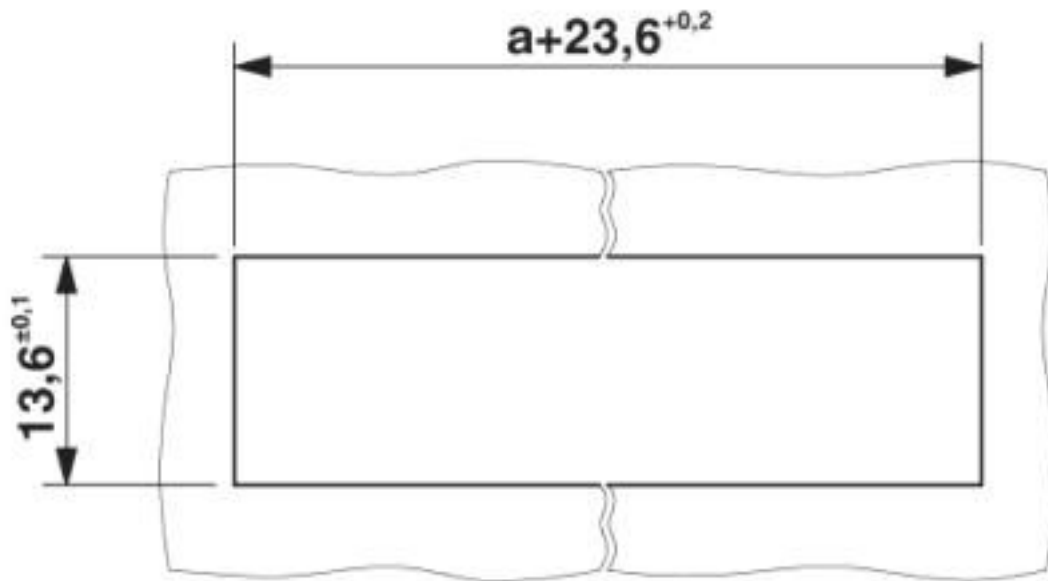

Sheet metal cutout for snap-on.

Feed-through header - DFK-PC 6-16/ 8-GU-10,16 - 1701676

Dimensional drawing

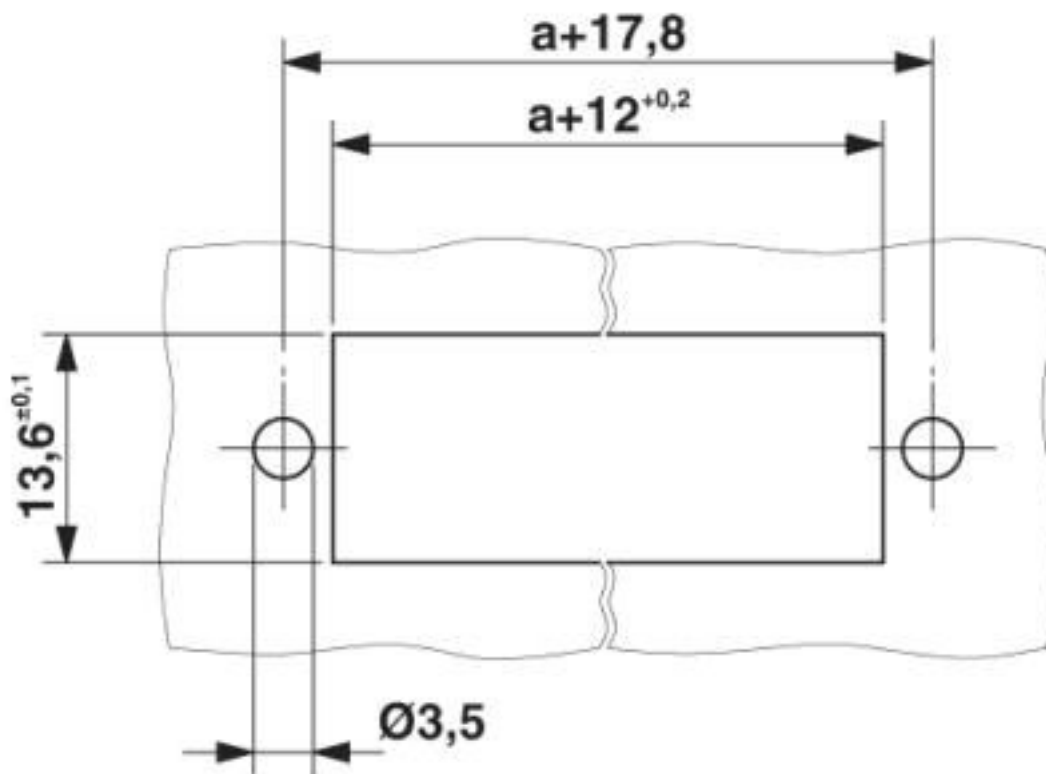

Sheet metal cutout for screw connection.

Classifications

eCl@ss

eCl@ss 10.0.1	27440402
eCl@ss 4.0	27260700
eCl@ss 4.1	27260700
eCl@ss 5.0	27260700
eCl@ss 5.1	27260700
eCl@ss 6.0	27260700
eCl@ss 7.0	27440402
eCl@ss 8.0	27440402
eCl@ss 9.0	27440402

ETIM

ETIM 3.0	EC001121
ETIM 4.0	EC002637
ETIM 5.0	EC002637
ETIM 6.0	EC002637
ETIM 7.0	EC002637

Feed-through header - DFK-PC 6-16/ 8-GU-10,16 - 1701676

Classifications

UNSPSC

UNSPSC 6.01	30211810
UNSPSC 7.0901	39121409
UNSPSC 11	39121409
UNSPSC 12.01	39121409
UNSPSC 13.2	39121409
UNSPSC 18.0	39121409
UNSPSC 19.0	39121409
UNSPSC 20.0	39121409
UNSPSC 21.0	39121409

Approvals

Approvals

Approvals

IECEE CB Scheme / SEV / EAC / cULus Recognized

Ex Approvals

Approval details

IECEE CB Scheme		http://www.iecee.org/	CH-10654-M1
Nominal voltage UN	1000 V		
Nominal current IN	76 A		

SEV		https://www.eurofins.ch/de/	IK-4469-M1
Nominal voltage UN	1000 V		
Nominal current IN	76 A		

EAC		B.01687	
-----	---	---------	--

Feed-through header - DFK-PC 6-16/ 8-GU-10,16 - 1701676

Approvals

cULus Recognized		http://database.ul.com/cgi-bin/XYV/template/LISEXT/1FRAME/index.htm	E60425-20040202
	B	C	D
Nominal voltage UN	300 V	300 V	600 V
Nominal current IN	66 A	66 A	5 A

Accessories

Accessories

Coding element

Coding profile - CP-PC RD - 1701967



Coding profile, for plugging into the coding ribs of the plug at a later date, insulating material, color: Red

Connector set

Accessories - DFK-PC MOUNT SET - 1054021

Contains 20 pcs. latch and screw elements for feed-through connectors each

Additional products

Printed-circuit board connector - PC 6/ 8-ST-10,16 - 1913565



PCB connector, nominal current: 41 A, rated voltage (III/2): 1000 V, nominal cross section: 6 mm², number of positions: 8, pitch: 10.16 mm, connection method: Screw connection with tension sleeve, color: green, contact surface: Silver

Printed-circuit board connector - PC 16/ 8-ST-10,16 - 1967430



PCB connector, nominal current: 76 A, rated voltage (III/2): 1000 V, nominal cross section: 16 mm², number of positions: 8, pitch: 10.16 mm, connection method: Screw connection with tension sleeve, color: green, contact surface: Silver

Feed-through header - DFK-PC 6-16/ 8-GU-10,16 - 1701676

Accessories

Printed-circuit board connector - TPC 16/ 8-ST-10,16 - 1715235



PCB connector, nominal current: 76 A, rated voltage (III/2): 1000 V, nominal cross section: 16 mm², number of positions: 8, pitch: 10.16 mm, connection method: Screw connection with tension sleeve, color: green, contact surface: Silver

Printed-circuit board connector - SPC 16/ 8-ST-10,16 - 1711323



PCB connector, nominal current: 76 A, rated voltage (III/2): 1000 V, nominal cross section: 16 mm², number of positions: 8, pitch: 10.16 mm, connection method: Push-in spring connection, color: green, contact surface: Silver

Phoenix Contact 2020 © - all rights reserved
<http://www.phoenixcontact.com>

PHOENIX CONTACT GmbH & Co. KG
Flachsmarktstr. 8
32825 Blomberg
Germany
Tel. +49 5235 300
Fax +49 5235 3 41200
<http://www.phoenixcontact.com>

X-ON Electronics

Largest Supplier of Electrical and Electronic Components

Click to view similar products for [Pluggable Terminal Blocks](#) category:

Click to view products by [Phoenix Contact](#) manufacturer:

Other Similar products are found below :

[57.510.0053](#) [MC 1.5/ 6-ST-3.5 GY AU](#) [734-104](#) [734-302](#) [8-141-P](#) [8426620000](#) [860505](#) [860810](#) [GBPACX-12](#) [93.731.4953.0](#) [PV05-5,08-K](#)
[PVP02-5,00](#) [PVP03-3,50](#) [PVP04-3,50](#) [PVS02-5,00](#) [1-1986160-3](#) [1377680000](#) [1531000000](#) [1546228-5](#) [ELFH16150](#) [ELFP03110](#)
[ELFP10210](#) [ELFT06250](#) [ELVP03100](#) [1700101](#) [1700410](#) [1700425](#) [1702246](#) [1705229](#) [1710175](#) [1714537](#) [1717806](#) [1719600](#) [1728941](#)
[1734692](#) [1734795](#) [1736036](#) [1740194](#) [1740291](#) [1740628](#) [1740990](#) [1746952](#) [1750207](#) [1752441](#) [1752865](#) [1754115](#) [1754144](#) [1756913](#)
[1760051](#) [1760336](#)