

Feed-through header - DFK-IPC 16/ 6-GF-SH-10,16 - 1703014

Please be informed that the data shown in this PDF Document is generated from our Online Catalog. Please find the complete data in the user's documentation. Our General Terms of Use for Downloads are valid (<http://phoenixcontact.com/download>)

Feed-through header, nominal current: 76 A, rated voltage (III/2): 1000 V, nominal cross section: 16 mm², number of positions: 6, pitch: 10.16 mm, color: green, contact surface: Silver, mounting: Wave soldering, pin layout: Linear pinning, solder pin [P]: 4.1 mm



The figure shows a 5-pos. version of the product

Your advantages

- Well-known mounting principle allows worldwide use
- Flange system enables secure fixing to the housing panel by means of tool-free snap-in locking or screws
- Inverted header with socket contacts for touch-proof device outputs or PCB/PCB connections
- Shroud for professional EMC shield feed-through on the inside of the device
- Screwable flange for superior mechanical stability
- Integrated double steel spring provides additional safety in the event of temperature and power fluctuations



Key Commercial Data

Packing unit	10 pc
GTIN	
GTIN	4046356031608

Technical data

Dimensions

Length [l]	34.55 mm
Width	102.04 mm
Pitch	10.16 mm
Dimension a	50.8 mm
Width [w]	102.04 mm
Height [h]	22 mm
Installed height	19.9 mm
Length of the solder pin	4.1 mm
Pin dimensions	0.8 x 1.2 mm

Feed-through header - DFK-IPC 16/ 6-GF-SH-10,16 - 1703014

Technical data

Dimensions

Pin spacing	10.16 mm
Length	34.55 mm

General

Range of articles	DFK-IPC 16/...GF-SH
Insulating material group	I
Rated surge voltage (III/3)	8 kV
Rated surge voltage (III/2)	8 kV
Rated surge voltage (II/2)	6 kV
Rated voltage (III/3)	1000 V
Rated voltage (III/2)	1000 V
Rated voltage (II/2)	1000 V
Connection in acc. with standard	EN-VDE
Nominal current I_N	76 A
Maximum load current	76 A
Insulating material	PA
Flammability rating according to UL 94	V0
Color	green
Number of positions	6

Standards and Regulations

Connection in acc. with standard	EN-VDE
	CUL
Flammability rating according to UL 94	V0

Environmental Product Compliance

China RoHS	Environmentally friendly use period: unlimited = EFUP-e
	No hazardous substances above threshold values

Drawings

Feed-through header - DFK-IPC 16/ 6-GF-SH-10,16 - 1703014

Drilling diagram

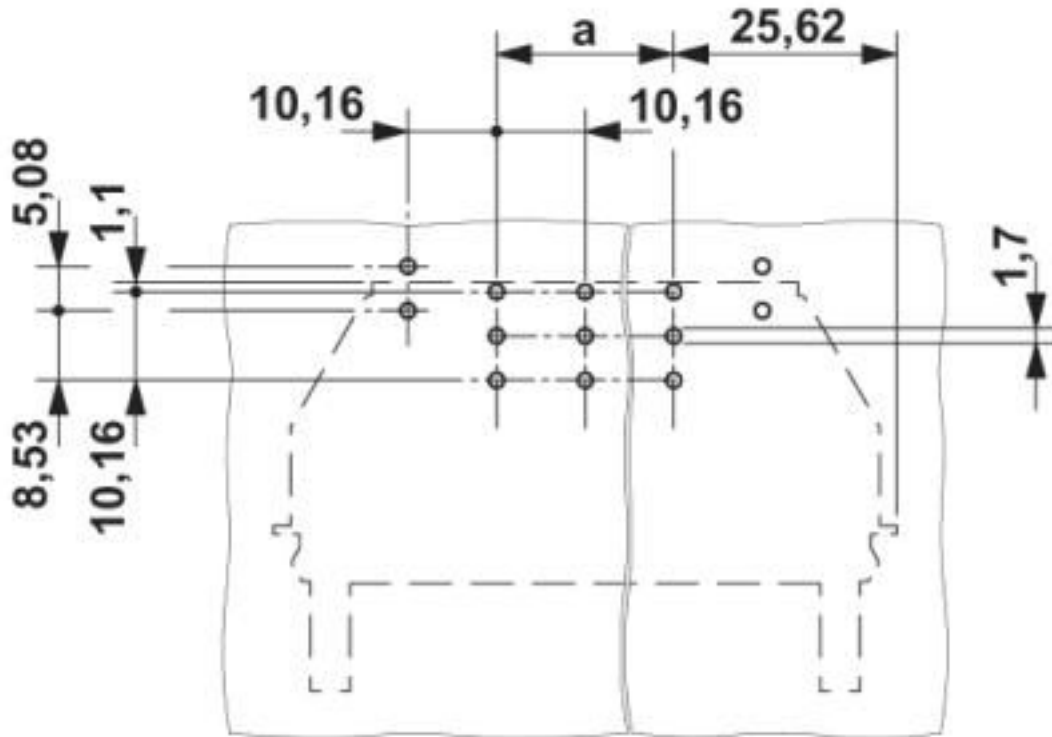

Diagram

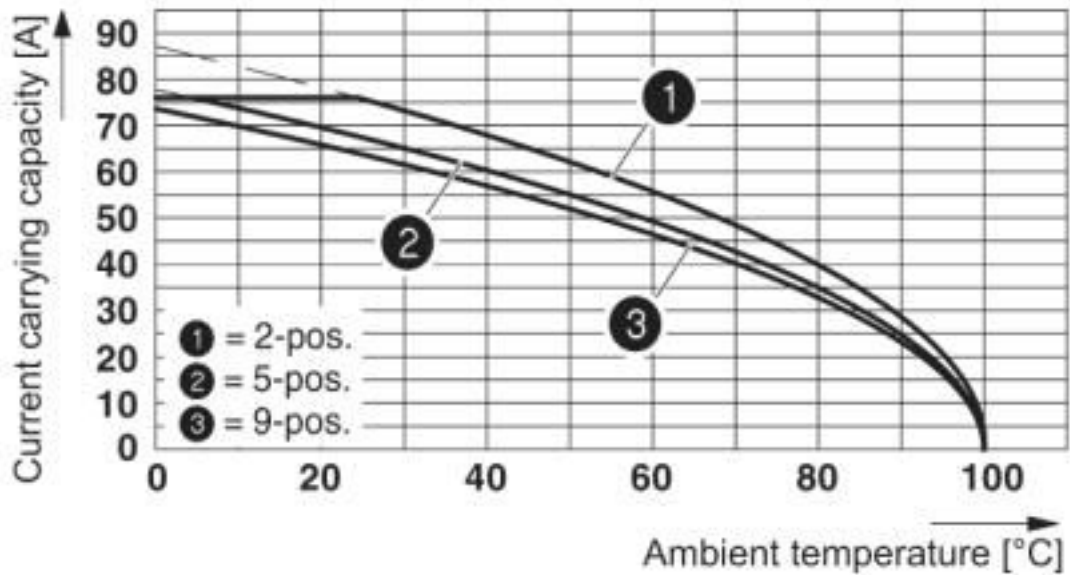

The figure shows the derating curve for DFK-IPC 16/...-G-10,16 inverted plugs in combination with the inverted header IPC 16/...-ST-10,16.

Feed-through header - DFK-IPC 16/ 6-GF-SH-10,16 - 1703014

Dimensional drawing

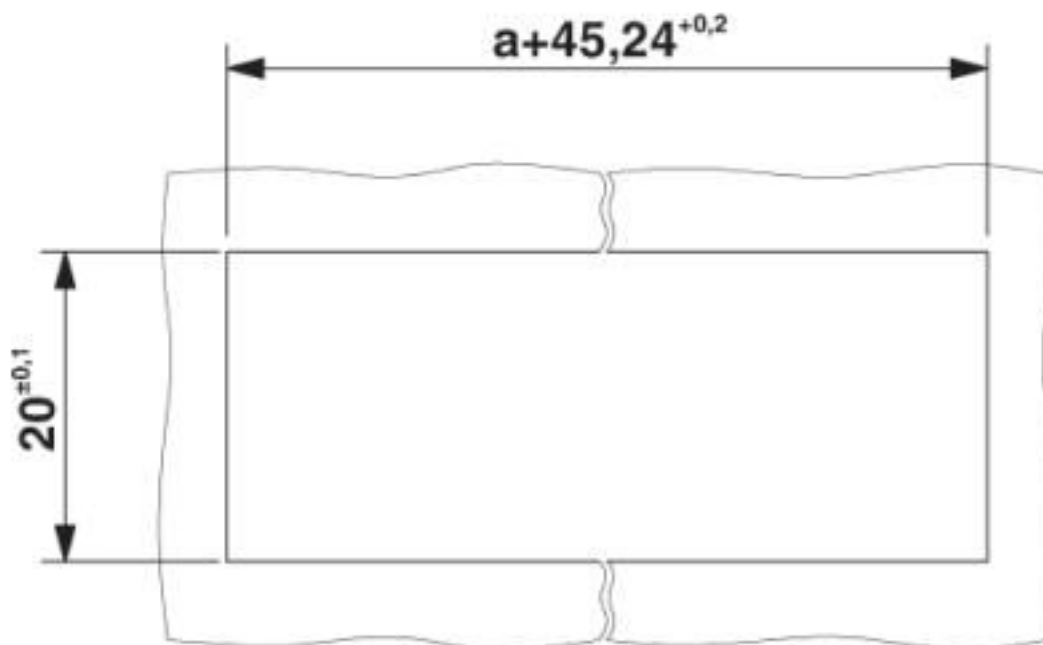

Sheet metal cutout for snap-on.

Feed-through header - DFK-IPC 16/ 6-GF-SH-10,16 - 1703014

Dimensional drawing

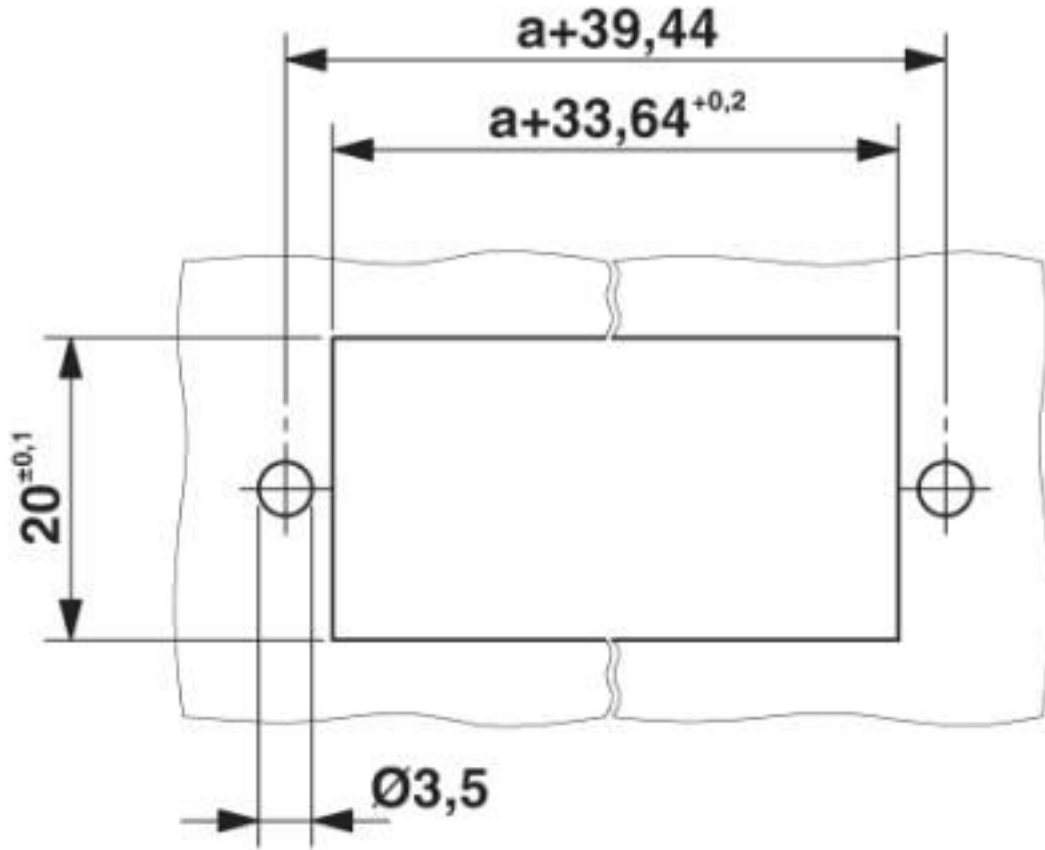

Sheet metal cutout for screw connection.

Dimensional drawing

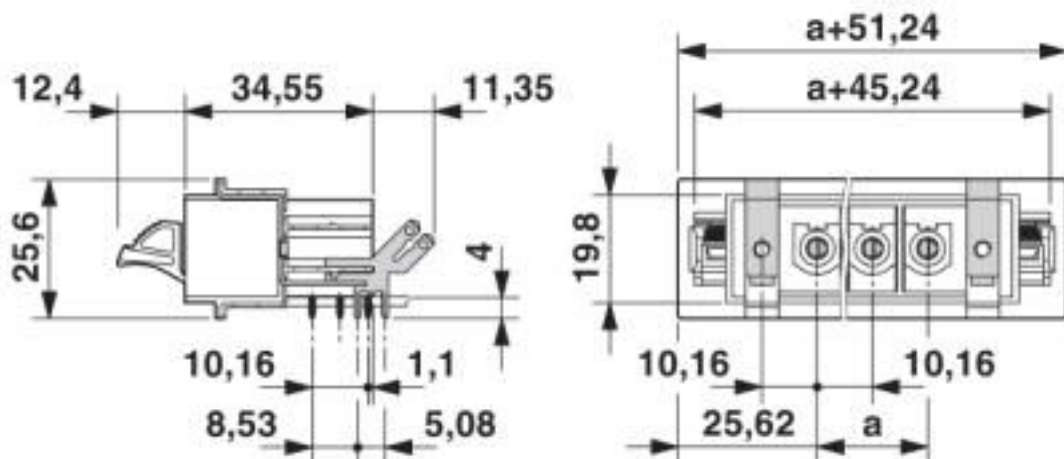

Feed-through header - DFK-IPC 16/ 6-GF-SH-10,16 - 1703014

Classifications

eCl@ss

eCl@ss 10.0.1	27440402
eCl@ss 4.0	27260700
eCl@ss 4.1	27260700
eCl@ss 5.0	27141100
eCl@ss 5.1	27141100
eCl@ss 6.0	27141100
eCl@ss 7.0	27141134
eCl@ss 8.0	27440402
eCl@ss 9.0	27440402

ETIM

ETIM 3.0	EC001121
ETIM 4.0	EC002637
ETIM 5.0	EC002637
ETIM 6.0	EC002637
ETIM 7.0	EC002637

UNSPSC

UNSPSC 6.01	30211810
UNSPSC 7.0901	39121409
UNSPSC 11	39121409
UNSPSC 12.01	39121409
UNSPSC 13.2	39121410
UNSPSC 18.0	39121409
UNSPSC 19.0	39121409
UNSPSC 20.0	39121409
UNSPSC 21.0	39121409

Approvals

Approvals

Approvals

IECEE CB Scheme / SEV / EAC / cULus Recognized

Ex Approvals

Approval details

Feed-through header - DFK-IPC 16/ 6-GF-SH-10,16 - 1703014

Approvals

IECEE CB Scheme		http://www.iecee.org/	CH-10654-M1
Nominal voltage UN	1000 V		
Nominal current IN	76 A		

SEV		https://www.eurofins.ch/de/	IK-4469-M1
Nominal voltage UN	1000 V		
Nominal current IN	76 A		

EAC		B.01687	
-----	--	---------	--

cULus Recognized		http://database.ul.com/cgi-bin/XYV/template/LISEXT/1FRAME/index.htm		E60425-20040202
	B	C	D	
Nominal voltage UN	300 V	300 V	600 V	
Nominal current IN	55 A	55 A	5 A	

Accessories

Accessories

Coding element

Coding profile - CP-PC RD - 1701967

Coding profile, for plugging into the coding ribs of the plug at a later date, insulating material, color: Red



Feed-through header - DFK-IPC 16/ 6-GF-SH-10,16 - 1703014

Accessories

Coding element - CS-IPC 16/ 6 - 1970016



Coding pin, serves to ensure correct polarization on the PCB during manual mounting

Connector set

Accessories - DFK-PC MOUNT SET - 1054021

Contains 20 pcs. latch and screw elements for feed-through connectors each

Mounting material

Accessories - DFK-PC 16-SS - 1705449



Screw set for DFK-PC 16... connectors

Screwdriver tools

Screwdriver - SZK PH1 VDE - 1205150



Screwdriver, PH crosshead, VDE insulated, size: PH 1 x 80 mm, 2-component grip, with non-slip grip

Screwdriver - SZS 0,6X2,5 VDE - 1205040



Screwdriver, slot-headed, VDE insulated, size: 0.6 x 2.5 x 80 mm, 2-component grip, with non-slip grip

Phoenix Contact 2020 © - all rights reserved
<http://www.phoenixcontact.com>

PHOENIX CONTACT GmbH & Co. KG
Flachsmarktstr. 8
32825 Blomberg
Germany
Tel. +49 5235 300
Fax +49 5235 3 41200
<http://www.phoenixcontact.com>

X-ON Electronics

Largest Supplier of Electrical and Electronic Components

Click to view similar products for [Pluggable Terminal Blocks](#) category:

Click to view products by [Phoenix Contact](#) manufacturer:

Other Similar products are found below :

[57.510.0053](#) [MC 1.5/ 6-ST-3.5 GY AU](#) [734-104](#) [734-302](#) [8-141-P](#) [8426620000](#) [860505](#) [860810](#) [GBPACX-12](#) [93.731.4953.0](#) [PV05-5,08-K](#)
[PVP02-5,00](#) [PVP03-3,50](#) [PVP04-3,50](#) [PVS02-5,00](#) [1-1986160-3](#) [1377680000](#) [1531000000](#) [1546228-5](#) [ELFH16150](#) [ELFP03110](#)
[ELFP10210](#) [ELFT06250](#) [ELVP03100](#) [1700101](#) [1700410](#) [1700425](#) [1702246](#) [1705229](#) [1710175](#) [1714537](#) [1717806](#) [1719600](#) [1728941](#)
[1734692](#) [1734795](#) [1736036](#) [1740194](#) [1740291](#) [1740628](#) [1740990](#) [1746952](#) [1750207](#) [1752441](#) [1752865](#) [1754115](#) [1754144](#) [1756913](#)
[1760051](#) [1760336](#)