

Feed-through plug - DFK-IPC 16/ 9-STF-SH-10,16 - 1704000

Please be informed that the data shown in this PDF Document is generated from our Online Catalog. Please find the complete data in the user's documentation. Our General Terms of Use for Downloads are valid (<http://phoenixcontact.com/download>)



Feed-through connector, nominal current: 76 A, rated voltage (III/2): 1000 V, nominal cross section: 16 mm², number of positions: 9, pitch: 10.16 mm, connection method: Screw connection with tension sleeve, color: green, contact surface: Silver

The figure shows a 5-pos. version of the product

Your advantages

- ✓ Well-known connection principle allows worldwide use
- ✓ Low temperature rise, thanks to maximum contact force
- ✓ Allows connection of two conductors
- ✓ Flange system enables secure fixing to the housing panel by means of tool-free snap-in locking or screws
- ✓ Inverted connector with pin contacts for touch-proof device outputs or free-hanging cable/cable connections
- ✓ Integrated double steel spring provides additional safety in the event of temperature and power fluctuations
- ✓ Shroud for professional EMC shield feed-through on the inside of the device
- ✓ Screwable flange for superior mechanical stability



Key Commercial Data

Packing unit	10 pc
GTIN	 4 017918 994761
GTIN	4017918994761

Technical data

Item properties

Brief article description	Feed-through plug
Plug-in system	POWER COMBICON 16
Type of contact	Female connector
Range of articles	DFK-IPC 16/...-STF-SH
Pitch	10.16 mm
Number of positions	9
Connection method	Screw connection with tension sleeve

Feed-through plug - DFK-IPC 16/ 9-STF-SH-10,16 - 1704000

Technical data

Item properties

Drive form screw head	Slotted (L)
Screw thread	M4
Locking	Screw flange
Number of levels	1
Number of connections	9
Number of potentials	9

Electrical parameters

Nominal current	76 A
Nom. voltage	1000 V
Rated voltage	1000 V
Rated voltage (III/2)	1000 V
Rated voltage (II/2)	1000 V
Rated surge voltage (III/3)	8 kV
Rated surge voltage (III/2)	8 kV
Rated surge voltage (II/2)	6 kV

Connection capacity

Connection method	Screw connection with tension sleeve
pluggable	Yes
Conductor cross section solid	0.75 mm ² ... 16 mm ²
Conductor cross section flexible	0.75 mm ² ... 16 mm ²
Conductor cross section AWG / kcmil	18 ... 6
Conductor cross section flexible, with ferrule without plastic sleeve	0.5 mm ² ... 16 mm ² (Only in connection with CRIMPFOX 16 S)
Conductor cross section, flexible, with ferrule, with plastic sleeve	0.5 mm ² ... 16 mm ² (Only in connection with CRIMPFOX 16 S)
2 conductors with same cross section, solid	0.75 mm ² ... 6 mm ²
2 conductors with same cross section, flexible	0.75 mm ² ... 6 mm ²
2 conductors with same cross section, flexible, with ferrule without plastic sleeve	0.5 mm ² ... 4 mm ²
2 conductors with the same cross section, flexible, with TWIN ferrule with plastic sleeve	0.5 mm ² ... 6 mm ²
Stripping length	12 mm
Torque	1.7 Nm ... 1.8 Nm

Flange specifications

Type of locking	Screw locking
Mounting flange	Screw flange

Material data - contact

Note	WEEE/RoHS-compliant, free of whiskers according to IEC 60068-2-82/ JEDEC JESD 201
Contact material	Cu alloy
Surface characteristics	Electroplated silver
Metal surface terminal point (top layer)	Tin (3 - 5 µm Sn)

Feed-through plug - DFK-IPC 16/ 9-STF-SH-10,16 - 1704000

Technical data

Material data - contact

Metal surface terminal point (middle layer)	Nickel (1.3 - 3 µm Ni)
Metal surface contact area (top layer)	Tin (3 - 5 µm Sn)
Metal surface contact area (middle layer)	Nickel (1.3 - 3 µm Ni),

Material data - housing

Housing color	green (6021)
Insulating material	PA
Insulating material group	I
CTI according to IEC 60112	600
Flammability rating according to UL 94	V0
Glow wire flammability index GWFI according to EN 60695-2-12	850
Glow wire ignition temperature GWIT according to EN 60695-2-13	775
Temperature for the ball pressure test according to EN 60695-10-2	125 °C

Dimensions for the product

Length [l]	56.4 mm
Width [w]	132.52 mm
Height [h]	32.05 mm
Pitch	10.16 mm
Height (without solder pin)	32.5 mm

Packaging information

Type of packaging	packed in cardboard
Pieces per package	10
Denomination packing units	Pcs.

Air clearances and creepage distances

Clearances and creepage distances	IEC 60664-1:2007-04
Specification	IEC 60664-1:2007-04
Minimum clearance - inhomogeneous field (III/3)	8 mm
Minimum clearance - inhomogeneous field (III/2)	8 mm
Minimum clearance - inhomogeneous field (II/2)	5.5 mm
Minimum creepage distance value (III/3)	12.5 mm
Minimum creepage distance value (III/2)	5 mm
Minimum creepage distance value (II/2)	5 mm

Environmental Product Compliance

REACH SVHC	Lead 7439-92-1
China RoHS	Environmentally Friendly Use Period = 50 years
	For details about hazardous substances go to tab "Downloads", Category "Manufacturer's declaration"

Drawings

Feed-through plug - DFK-IPC 16/ 9-STF-SH-10,16 - 1704000

Drilling diagram

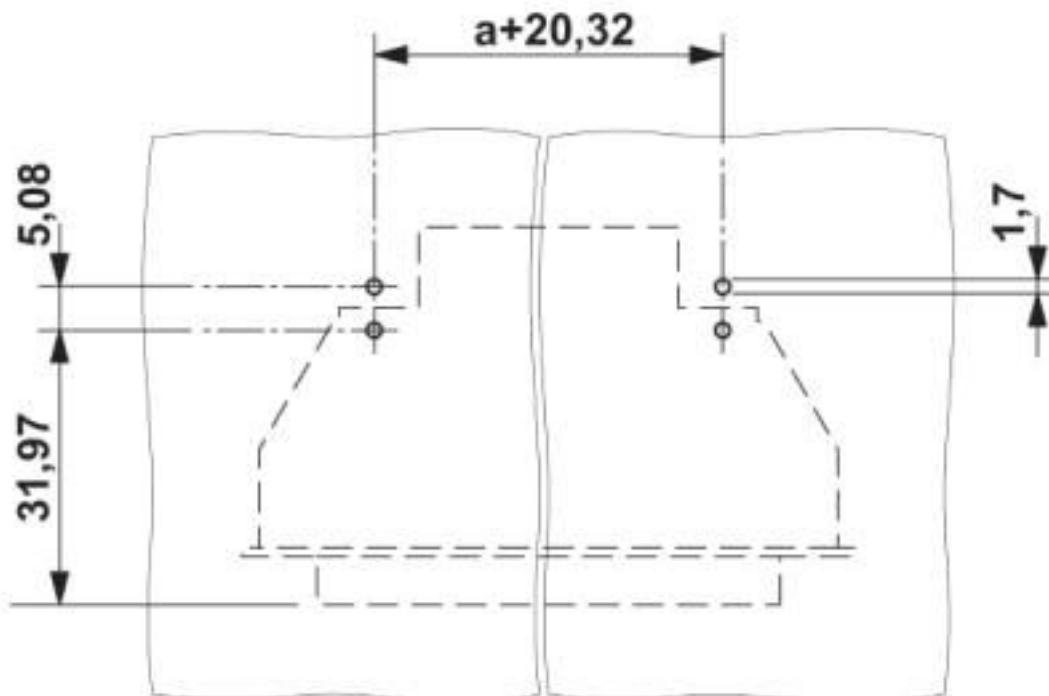

Diagram

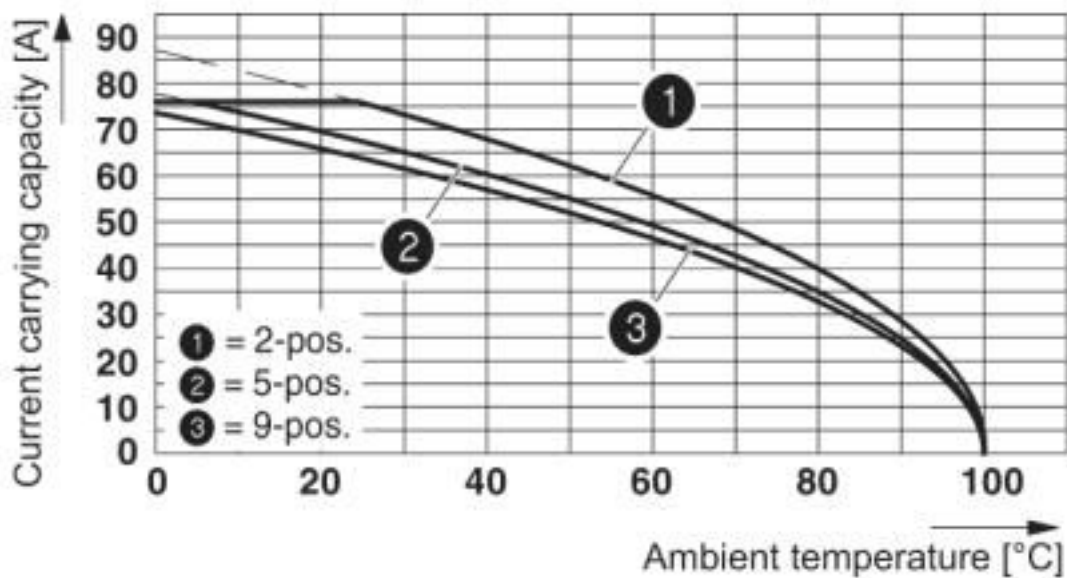

Derating curve for: IPC 16/...-ST-10.16 with DFK-IPC 16/...-ST-10.16

Feed-through plug - DFK-IPC 16/ 9-STF-SH-10,16 - 1704000

Dimensional drawing

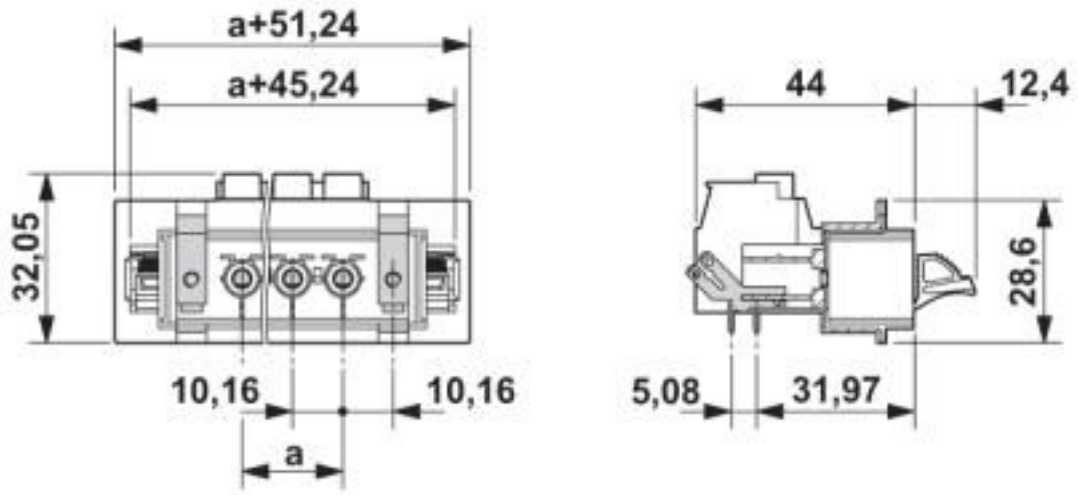

Dimensional drawing

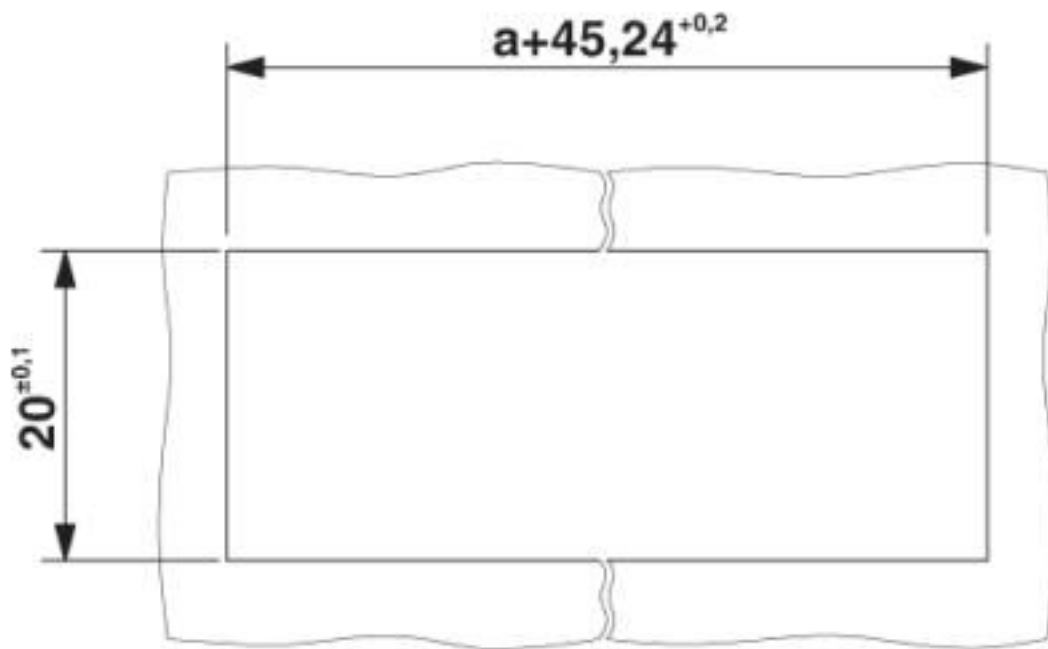

Sheet metal cutout for snap-on.

Feed-through plug - DFK-IPC 16/ 9-STF-SH-10,16 - 1704000

Dimensional drawing

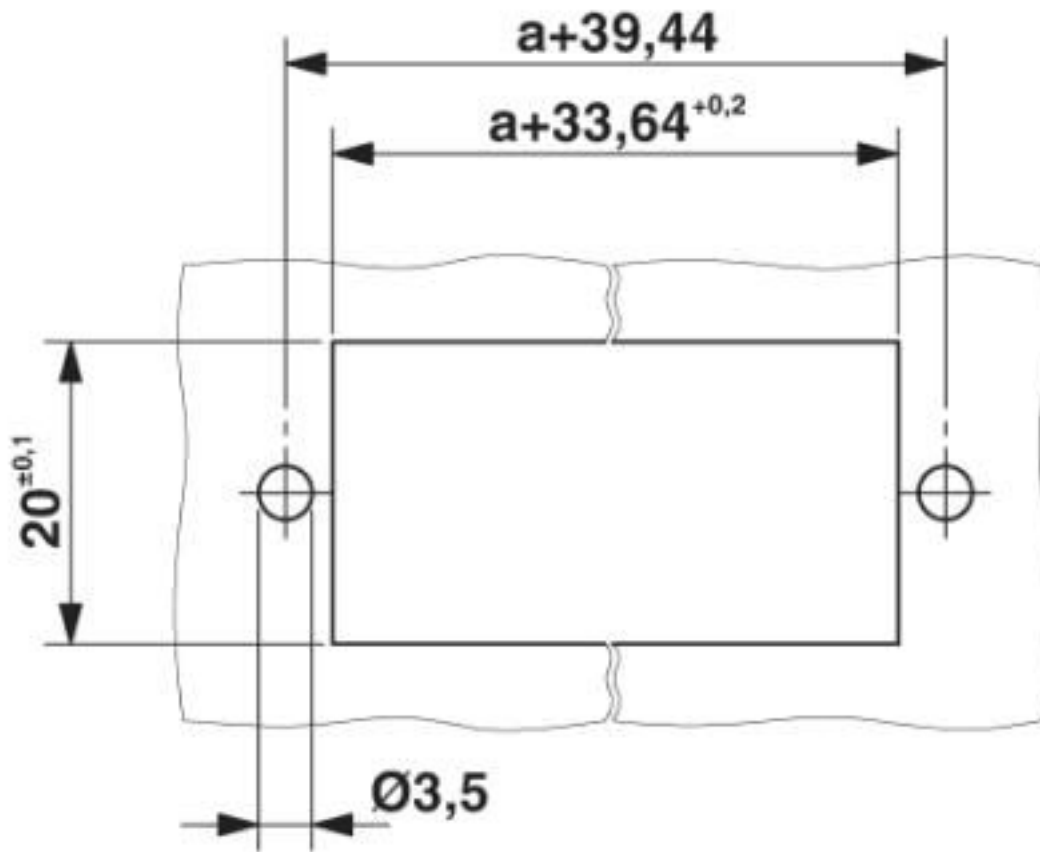

Sheet metal cutout for screw connection.

Classifications

eCl@ss

eCl@ss 10.0.1	27440309
eCl@ss 4.0	27260700
eCl@ss 4.1	27260700
eCl@ss 5.0	27141100
eCl@ss 5.1	27141100
eCl@ss 6.0	27141100
eCl@ss 7.0	27141134
eCl@ss 8.0	27440309
eCl@ss 9.0	27440309

ETIM

ETIM 3.0	EC001121
ETIM 4.0	EC002638
ETIM 5.0	EC002638

Feed-through plug - DFK-IPC 16/ 9-STF-SH-10,16 - 1704000

Classifications

ETIM

ETIM 6.0	EC002638
ETIM 7.0	EC002638

UNSPSC

UNSPSC 6.01	30211810
UNSPSC 7.0901	39121409
UNSPSC 11	39121409
UNSPSC 12.01	39121409
UNSPSC 13.2	39121410
UNSPSC 18.0	39121409
UNSPSC 19.0	39121409
UNSPSC 20.0	39121409
UNSPSC 21.0	39121409

Approvals

Approvals

Approvals

EAC / cULus Recognized / IECEE CB Scheme / SEV

Ex Approvals

Approval details

EAC		B.01687
-----	---	---------

cULus Recognized		http://database.ul.com/cgi-bin/XYV/template/LISEXT/1FRAME/index.htm	E60425-20040202
	B	C	
Nominal voltage UN	600 V	600 V	
Nominal current IN	55 A	55 A	
mm ² /AWG/kcmil	20-6	20-6	

Feed-through plug - DFK-IPC 16/ 9-STF-SH-10,16 - 1704000

Approvals

IECEE CB Scheme		http://www.iecee.org/	CH-10654-M1
Nominal voltage UN	1000 V		
Nominal current IN	76 A		
mm ² /AWG/kcmil	0.75-16		

SEV		https://www.eurofins.ch/de/	IK-4469-M1
Nominal voltage UN	1000 V		
Nominal current IN	76 A		
mm ² /AWG/kcmil	0.75-16		

Accessories

Accessories

Coding element

Coding profile - CP-PC RD - 1701967



Coding profile, for plugging into the coding ribs of the plug at a later date, insulating material, color: Red

Connector

Connector - C-SCF 2,5/6,3X0,8 - 3240159



Slip-on sleeve, non-insulated, 1.5 ... 2.5 mm², 6.3 x 0.8

Connector - C-SCF 6/6,3X0,8 - 3240160



Slip-on sleeve, non-insulated, 4 ... 6 mm², 6.3 x 0.8

Feed-through plug - DFK-IPC 16/ 9-STF-SH-10,16 - 1704000

Accessories

Connector - C-SCF 1,5/6,3X0,8 - 3240156



Slip-on sleeve, non-insulated, 0.5 ... 1.5 mm², 6.3 x 0.8

Connector - C-SCFI 6/6,3X0,8 - 3240056



Slip-on sleeve, yellow, 4 ... 6 mm², 6.3 x 0.8

Connector - C-SCFI 1,5/6,3X0,8 - 3240052



Slip-on sleeve, red, 0.5 ... 1.5 mm², 6.3 x 0.8

Connector - C-SCFFI 2,5/6,3X0,8 - 3240547



Slip-on sleeve, fully isolated, blue, 1.5 ... 2.5 mm², for plug 6.3 x 0.8 mm

Connector - C-SCFI 2,5/6,3X0,8 - 3240055



Slip-on sleeve, blue, 1.5 ... 2.5 mm², 6.3 x 0.8

Feed-through plug - DFK-IPC 16/ 9-STF-SH-10,16 - 1704000

Accessories

Connector - C-SCFFI 6/6,3X0,8 - 3240541



Slip-on sleeve, fully insulated, yellow, 4 ... 6 mm², for 6.3 x 0.8 mm plugs

Connector - C-SCFFI 1,5/6,3X0,8 - 3240538



Slip-on sleeve, fully isolated, red, 0.5 ... 1.5 mm², for plug 6.3 x 0.8 mm

Connector set

Accessories - DFK-PC MOUNT SET - 1054021

Contains 20 pcs. latch and screw elements for feed-through connectors each

Additional products

Printed-circuit board connector - IPC 16/ 9-STF-10,16 - 1969522



PCB connector, nominal current: 76 A, rated voltage (III/2): 1000 V, nominal cross section: 16 mm², number of positions: 9, pitch: 10.16 mm, connection method: Screw connection with tension sleeve, color: green, contact surface: Silver

Printed-circuit board connector - ISPC 16/ 9-STF-10,16 - 1748697



PCB connector, nominal current: 76 A, rated voltage (III/2): 1000 V, nominal cross section: 16 mm², number of positions: 9, pitch: 10.16 mm, connection method: Push-in spring connection, color: green, contact surface: Silver

Phoenix Contact 2020 © - all rights reserved
<http://www.phoenixcontact.com>

PHOENIX CONTACT GmbH & Co. KG
Flachmarktstr. 8
32825 Blomberg
Germany
Tel. +49 5235 300
Fax +49 5235 3 41200
<http://www.phoenixcontact.com>

X-ON Electronics

Largest Supplier of Electrical and Electronic Components

Click to view similar products for [Pluggable Terminal Blocks](#) category:

Click to view products by [Phoenix Contact](#) manufacturer:

Other Similar products are found below :

[57.510.0053](#) [MC 1.5/ 6-ST-3.5 GY AU](#) [734-104](#) [734-302](#) [8-141-P](#) [8426620000](#) [860505](#) [860810](#) [GBPACX-12](#) [93.731.4953.0](#) [PV05-5,08-K](#)
[PVP02-5,00](#) [PVP03-3,50](#) [PVP04-3,50](#) [PVS02-5,00](#) [1-1986160-3](#) [1377680000](#) [1531000000](#) [1546228-5](#) [ELFH16150](#) [ELFP03110](#)
[ELFP10210](#) [ELFT06250](#) [ELVP03100](#) [1700101](#) [1700410](#) [1700425](#) [1702246](#) [1705229](#) [1710175](#) [1714537](#) [1717806](#) [1719600](#) [1728941](#)
[1734692](#) [1734795](#) [1736036](#) [1740194](#) [1740291](#) [1740628](#) [1740990](#) [1746952](#) [1750207](#) [1752441](#) [1752865](#) [1754115](#) [1754144](#) [1756913](#)
[1760051](#) [1760336](#)