

Printed-circuit board connector - MCV 0,5/ 2-G-2,54 P20THRR24C2 - 1706169

Please be informed that the data shown in this PDF Document is generated from our Online Catalog. Please find the complete data in the user's documentation. Our General Terms of Use for Downloads are valid (<http://phoenixcontact.com/download>)

PCB headers, nominal current: 6 A, rated voltage (III/2): 160 V, nominal cross section: 0.5 mm², number of positions: 2, pitch: 2.54 mm, color: black, contact surface: Gold, mounting: THR soldering, pin layout: Linear pinning, solder pin [P]: 2 mm, Fixed coding of the last position, can be combined with the FMC 0,5/...-ST-2,54 C2 connector



The figure shows the 10-position version

Your advantages

- ✓ Designed for integration into the SMT soldering process
- ✓ Additional solder anchors reduce the mechanical strain on the soldering spots
- ✓ Gold-plated contacts ensure transfer quality remains stable over the long term
- ✓ Vertical connection enables multi-row arrangement on the PCB
- ✓ Supplied in tape-on-reel packing according to IEC 60286-3 for automated mounting



Key Commercial Data

Packing unit	315 pc
Minimum order quantity	315 pc
GTIN	
GTIN	4046356841856

Technical data

Dimensions

Length [l]	4.8 mm
Width	9.62 mm
Pitch	2.54 mm
Dimension a	2.54 mm
Width [w]	9.62 mm
Height [h]	9.1 mm
Installed height	7.1 mm
Length of the solder pin	2 mm

Printed-circuit board connector - MCV 0,5/ 2-G-2,54 P20THRR24C2 - 1706169

Technical data

Dimensions

Pin dimensions	0.64 x 0.64 mm
Length	4.8 mm

General

Range of articles	MCV 0,5/...-G-THR
Insulating material group	IIIa
Rated surge voltage (III/3)	2.5 kV
Rated surge voltage (III/2)	2.5 kV
Rated surge voltage (II/2)	2.5 kV
Rated voltage (III/3)	32 V
Rated voltage (III/2)	160 V
Rated voltage (II/2)	160 V
Connection in acc. with standard	EN-VDE
Nominal current I _N	6 A
Insulating material	LCP
Flammability rating according to UL 94	V0
Color	black
Number of positions	2

Standards and Regulations

Connection in acc. with standard	EN-VDE
Flammability rating according to UL 94	V0

Environmental Product Compliance

China RoHS	Environmentally friendly use period: unlimited = EFUP-e
	No hazardous substances above threshold values

Drawings

Printed-circuit board connector - MCV 0,5/ 2-G-2,54 P20THRR24C2 - 1706169

Drilling diagram

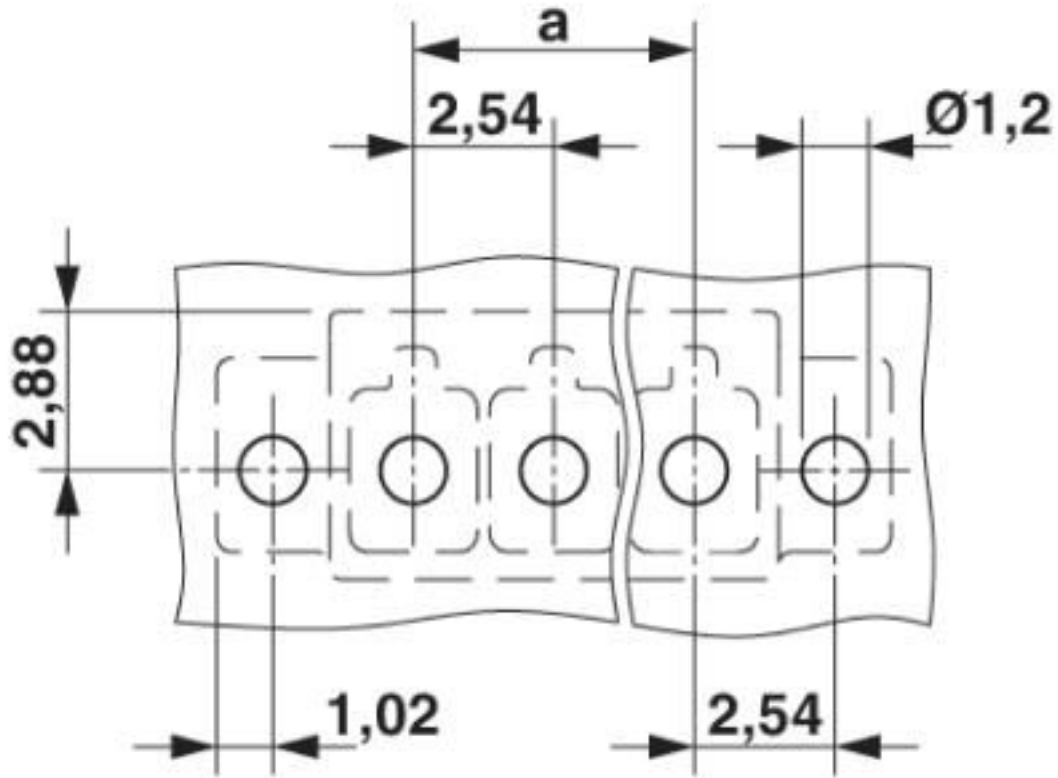

Diagram

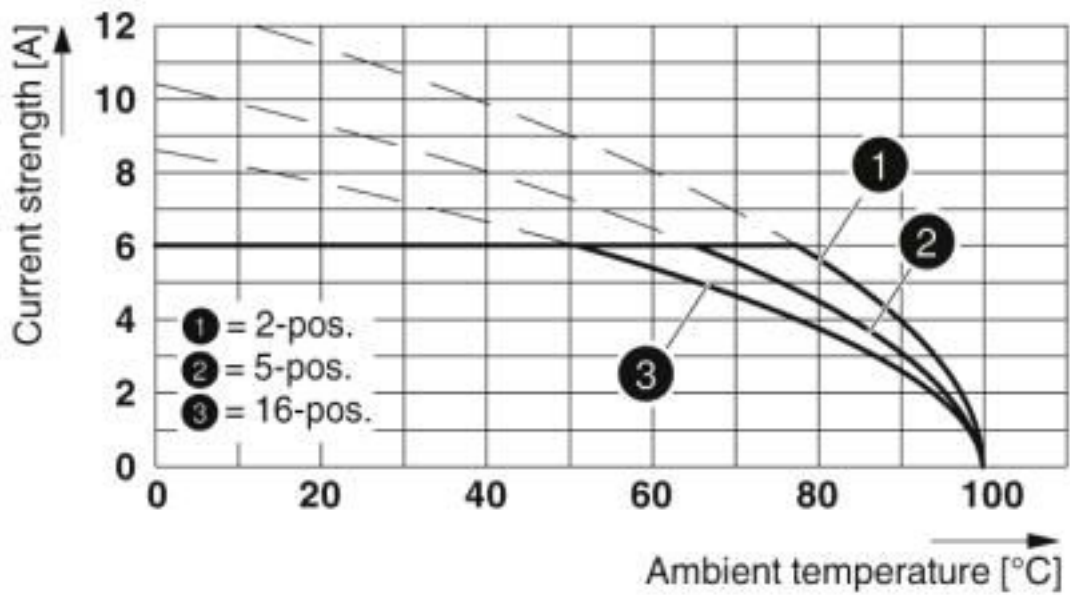

Printed-circuit board connector - MCV 0,5/ 2-G-2,54 P20THRR24C2 - 1706169

Dimensional drawing

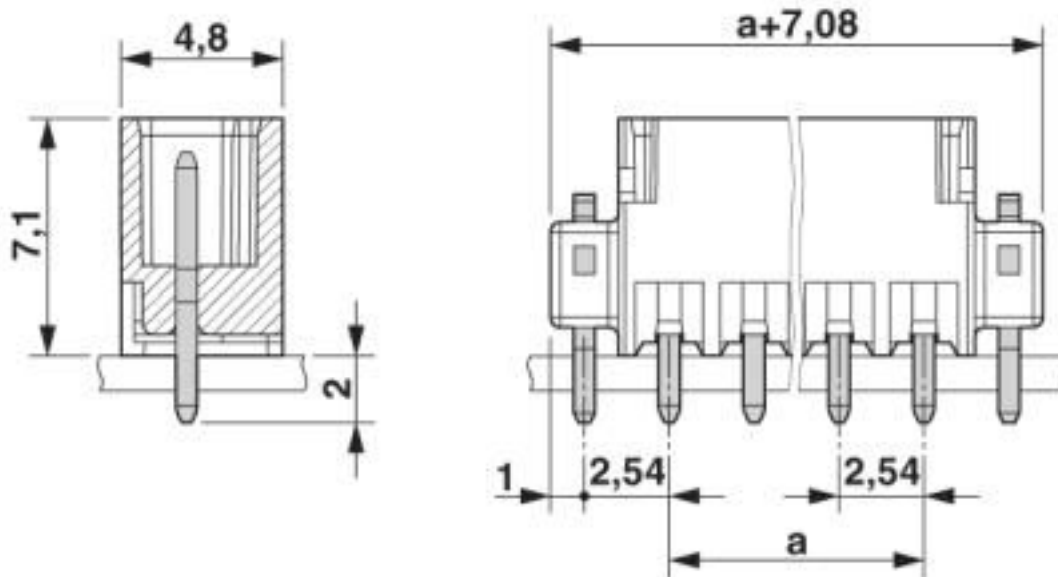

Classifications

eCl@ss

eCl@ss 10.0.1	27440402
eCl@ss 4.0	27260700
eCl@ss 4.1	27260700
eCl@ss 5.0	27260700
eCl@ss 5.1	27260700
eCl@ss 6.0	27260700
eCl@ss 7.0	27440402
eCl@ss 8.0	27440402
eCl@ss 9.0	27440402

ETIM

ETIM 3.0	EC001121
ETIM 4.0	EC002637
ETIM 5.0	EC002637
ETIM 6.0	EC002637
ETIM 7.0	EC002637

UNSPSC

UNSPSC 6.01	30211810
UNSPSC 7.0901	39121409
UNSPSC 11	39121409
UNSPSC 12.01	39121409

Printed-circuit board connector - MCV 0,5/ 2-G-2,54 P20THRR24C2 - 1706169

Classifications

UNSPSC

UNSPSC 13.2	39121409
UNSPSC 18.0	39121409
UNSPSC 19.0	39121409
UNSPSC 20.0	39121409
UNSPSC 21.0	39121409

Approvals

Approvals

Approvals

IECEE CB Scheme / VDE Gutachten mit Fertigungsüberwachung / EAC / cULus Recognized

Ex Approvals

Approval details

IECEE CB Scheme		http://www.iecee.org/	DE1-63595
Nominal voltage UN	160 V		
Nominal current IN	6 A		

VDE Gutachten mit Fertigungsüberwachung		http://www2.vde.com/de/Institut/Online-Service/VDE-gepruefteProdukte/Seiten/Online-Suche.aspx	40042258
Nominal voltage UN	160 V		
Nominal current IN	6 A		

EAC		B.01687
-----	---	---------

Printed-circuit board connector - MCV 0,5/ 2-G-2,54 P20THRR24C2 - 1706169

Approvals

cULus Recognized		http://database.ul.com/cgi-bin/XYV/template/LISEXT/1FRAME/index.htm	E60425-19920306
	B	C	
Nominal voltage UN	150 V	50 V	
Nominal current IN	6 A	6 A	

Accessories

Accessories

Labeled terminal marker

Marker card - SK 2,54/2,8:FORTL.ZAHLEN - 0804853



Marker card, Card, white, labeled, horizontal: consecutive numbers 1 ... 10, 11 ... 20, etc. up to 91 ... 99, mounting type: adhesive, for terminal block width: 2.54 mm, lettering field size: 2.54 x 2.8 mm

Additional products

Printed-circuit board connector - FMC 0,5/ 2-ST-2,54 C2 - 1706243



PCB connector, nominal current: 6 A, rated voltage (III/2): 160 V, nominal cross section: 0.5 mm², number of positions: 2, pitch: 2.54 mm, connection method: Push-in spring connection, color: black, contact surface: Gold, Fixed coding of last position; can be combined with MC(V) 0,5/...-G-2,54...C2 headers

Phoenix Contact 2020 © - all rights reserved
<http://www.phoenixcontact.com>

PHOENIX CONTACT GmbH & Co. KG
Flachsmarktstr. 8
32825 Blomberg
Germany
Tel. +49 5235 300
Fax +49 5235 3 41200
<http://www.phoenixcontact.com>

X-ON Electronics

Largest Supplier of Electrical and Electronic Components

Click to view similar products for [Pluggable Terminal Blocks](#) category:

Click to view products by [Phoenix Contact](#) manufacturer:

Other Similar products are found below :

[57.510.0053](#) [MC 1.5/ 6-ST-3.5 GY AU](#) [734-104](#) [734-302](#) [8-141-P](#) [8426620000](#) [860505](#) [860810](#) [GBPACX-12](#) [93.731.4953.0](#) [PV05-5,08-K](#)
[PVP02-5,00](#) [PVP03-3,50](#) [PVP04-3,50](#) [PVS02-5,00](#) [1-1986160-3](#) [1377680000](#) [1531000000](#) [1546228-5](#) [ELFH16150](#) [ELFP03110](#)
[ELFP10210](#) [ELFT06250](#) [ELVP03100](#) [1700101](#) [1700410](#) [1700425](#) [1702246](#) [1705229](#) [1710175](#) [1714537](#) [1717806](#) [1719600](#) [1728941](#)
[1734692](#) [1734795](#) [1736036](#) [1740194](#) [1740291](#) [1740628](#) [1740990](#) [1746952](#) [1750207](#) [1752441](#) [1752865](#) [1754115](#) [1754144](#) [1756913](#)
[1760051](#) [1760336](#)