

# Printed-circuit board connector - MCV 1,5/ 4-GF-3,81 P26 THR - 1707654

Please be informed that the data shown in this PDF Document is generated from our Online Catalog. Please find the complete data in the user's documentation. Our General Terms of Use for Downloads are valid (<http://phoenixcontact.com/download>)

PCB headers, nominal current: 8 A, rated voltage (III/2): 160 V, nominal cross section: 1.5 mm<sup>2</sup>, number of positions: 4, pitch: 3.81 mm, color: black, contact surface: Tin, mounting: THR soldering, pin layout: Linear pinning, solder pin [P]: 2.6 mm, User information and design recommendations for through hole reflow technology can be found under: Downloads



The figure shows a 10-position version of the product

## Your advantages

- Designed for integration into the SMT soldering process
- Screwable flange for superior mechanical stability
- Vertical connection enables multi-row arrangement on the PCB
- Maximum flexibility when it comes to device design – one header for connectors with different connection technologies



## Key Commercial Data

Packing unit	50 pc
GTIN	
GTIN	4046356034357

## Technical data

### Dimensions

Length [ l ]	7.25 mm
Width	25.63 mm
Pitch	3.81 mm
Dimension a	11.43 mm
Width [ w ]	25.63 mm
Height [ h ]	11.8 mm
Installed height	9.2 mm
Length of the solder pin	2.6 mm
Pin dimensions	0.8 x 0.8 mm
Length	7.25 mm

### General

# Printed-circuit board connector - MCV 1,5/ 4-GF-3,81 P26 THR - 1707654

## Technical data

### General

Range of articles	MCV 1,5/...-GF-THR
Insulating material group	IIIa
Rated surge voltage (III/3)	2.5 kV
Rated surge voltage (III/2)	2.5 kV
Rated surge voltage (II/2)	2.5 kV
Rated voltage (III/3)	160 V
Rated voltage (III/2)	160 V
Rated voltage (II/2)	250 V
Connection in acc. with standard	EN-VDE
Nominal current I <sub>N</sub>	8 A
Maximum load current	8 A
Insulating material	LCP
Flammability rating according to UL 94	V0
Color	black
Number of positions	4

### General information

Type of note	Details for soldering processes
Note	Processing using reflow processes in compliance with IEC 60068-2-58 or DIN EN 61760-1 (latest version) Moisture Sensitive Level (MSL) = 1 according to IPC/JEDEC J-STD-020-C

### Standards and Regulations

Connection in acc. with standard	EN-VDE
	CUL
Flammability rating according to UL 94	V0

### Environmental Product Compliance

REACH SVHC	Lead 7439-92-1
China RoHS	Environmentally Friendly Use Period = 50 years
	For details about hazardous substances go to tab "Downloads", Category "Manufacturer's declaration"

## Drawings

# Printed-circuit board connector - MCV 1,5/ 4-GF-3,81 P26 THR - 1707654

Drilling diagram

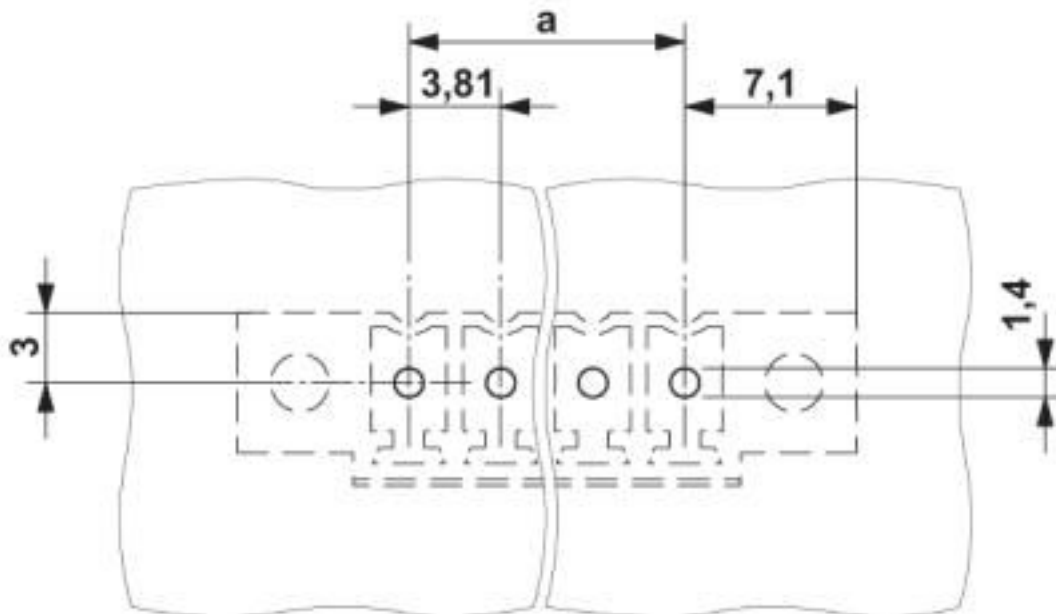

Diagram

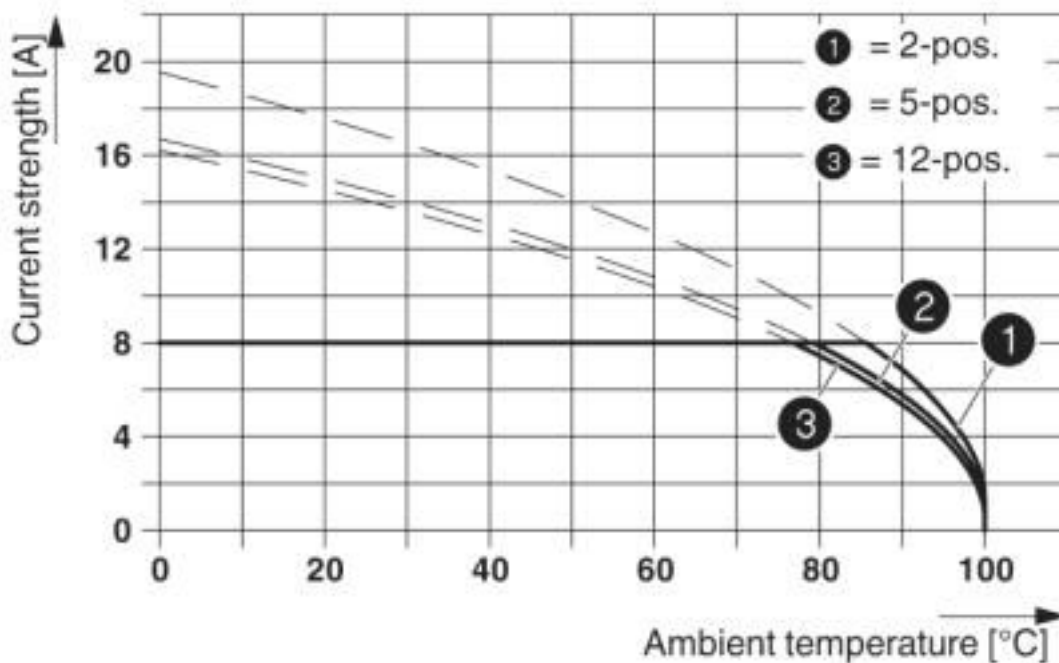

The figure shows the derating curve for plugs MC 1,5/...STF-3,81 in combination with header MCV 1,5/...GF-3,81 P26 THR.

# Printed-circuit board connector - MCV 1,5/ 4-GF-3,81 P26 THR - 1707654

Diagram

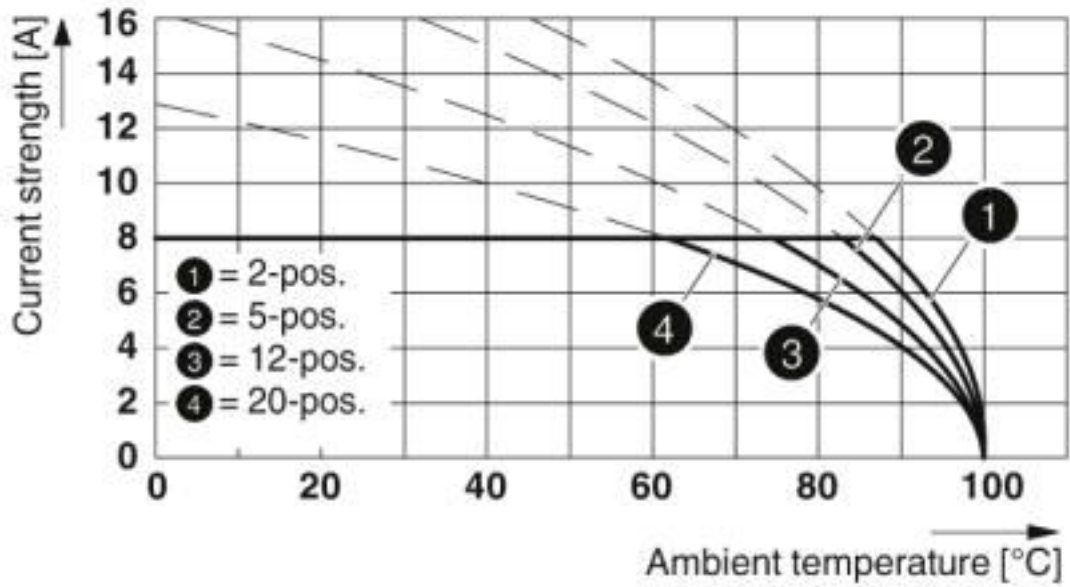

Type: FMC 1,5/...-STF-3,81 with MCV 1,5/...-GF-3,81 P... THR

Diagram

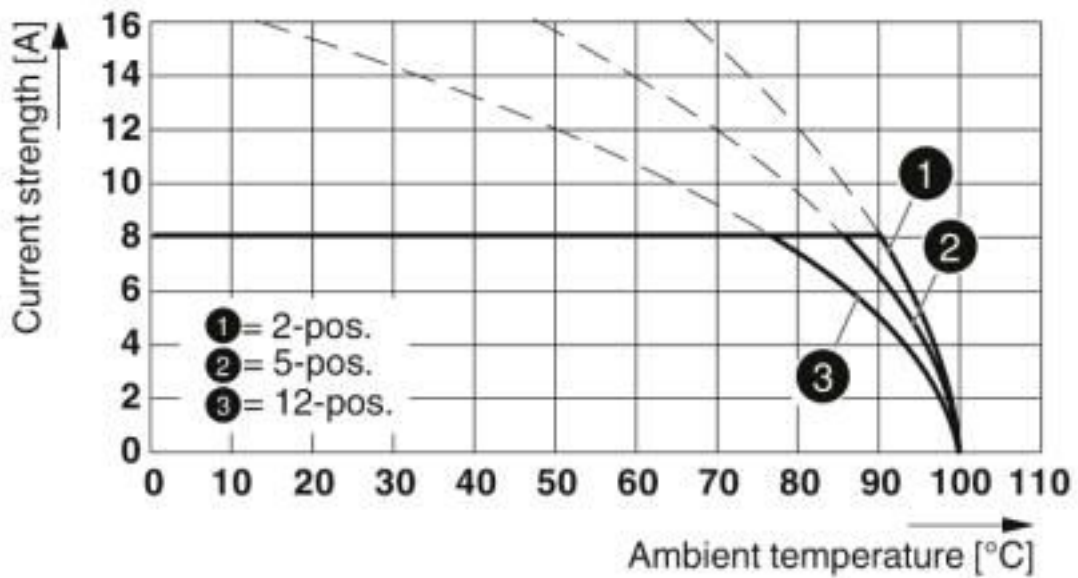

Type: MC 1,5/...-STF-3,81 with MCV 1,5/...-GF-3,81 P26 THR

# Printed-circuit board connector - MCV 1,5/ 4-GF-3,81 P26 THR - 1707654

Dimensional drawing

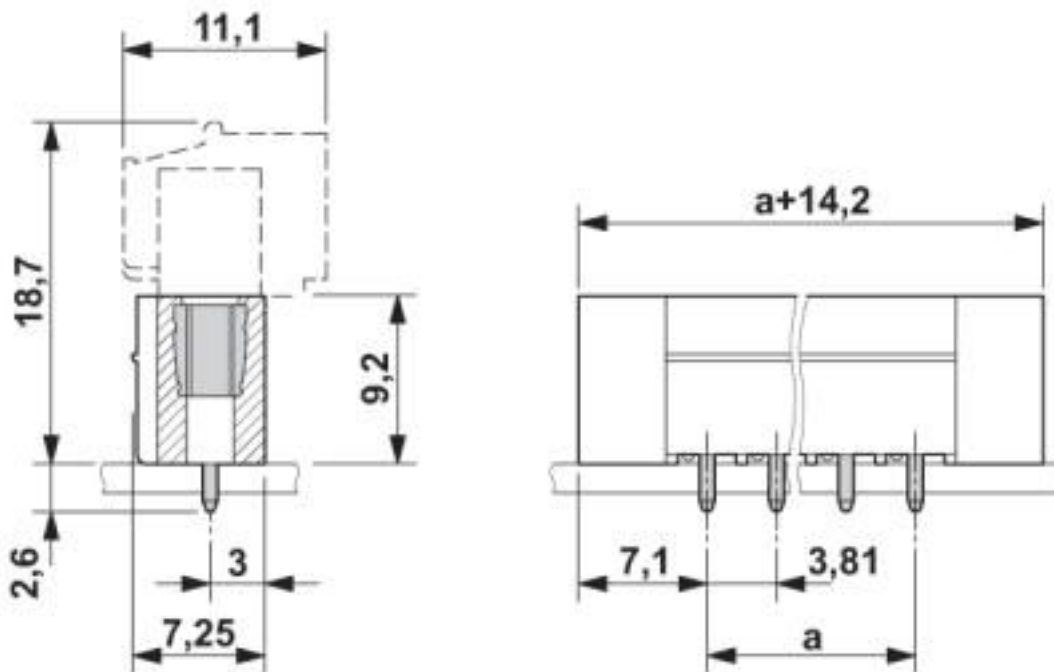

## Classifications

eCl@ss

eCl@ss 10.0.1	27440402
eCl@ss 4.0	27260700
eCl@ss 4.1	27260700
eCl@ss 5.0	27260700
eCl@ss 5.1	27260700
eCl@ss 6.0	27260700
eCl@ss 7.0	27440402
eCl@ss 8.0	27440402
eCl@ss 9.0	27440402

ETIM

ETIM 3.0	EC001121
ETIM 4.0	EC002637
ETIM 5.0	EC002637
ETIM 6.0	EC002637
ETIM 7.0	EC002637

UNSPSC

UNSPSC 6.01	30211810
UNSPSC 7.0901	39121409
UNSPSC 11	39121409

# Printed-circuit board connector - MCV 1,5/ 4-GF-3,81 P26 THR - 1707654

## Classifications

### UNSPSC

UNSPSC 12.01	39121409
UNSPSC 13.2	39121409
UNSPSC 18.0	39121409
UNSPSC 19.0	39121409
UNSPSC 20.0	39121409
UNSPSC 21.0	39121409

## Approvals

### Approvals

#### Approvals

IECEE CB Scheme / VDE Gutachten mit Fertigungsüberwachung / EAC / cULus Recognized

#### Ex Approvals

### Approval details

IECEE CB Scheme		<a href="http://www.iecee.org/">http://www.iecee.org/</a>	DE1-60987-B1B2
Nominal voltage UN	160 V		
Nominal current IN	8 A		

VDE Gutachten mit Fertigungsüberwachung		<a href="http://www2.vde.com/de/Institut/Online-Service/VDE-gepruefteProdukte/Seiten/Online-Suche.aspx">http://www2.vde.com/de/Institut/Online-Service/VDE-gepruefteProdukte/Seiten/Online-Suche.aspx</a>	40011723
Nominal voltage UN	160 V		
Nominal current IN	8 A		

EAC		B.01687
-----	---	---------

# Printed-circuit board connector - MCV 1,5/ 4-GF-3,81 P26 THR - 1707654

## Approvals

cULus Recognized		<a href="http://database.ul.com/cgi-bin/XYV/template/LISEXT/1FRAME/index.htm">http://database.ul.com/cgi-bin/XYV/template/LISEXT/1FRAME/index.htm</a>	E60425-20110128
	B	D	
Nominal voltage UN	300 V	300 V	
Nominal current IN	8 A	8 A	

## Accessories

### Accessories

#### Coding element

Coding profile - CP-MSTB - 1734634

Coding profile, is inserted into the slot on the plug or inverted header, red insulating material



### Fiber optic

Fiber optic - MC 1,5/10-LWL 1,5-3,81 - 1841174

MINI COMBICON fiber optics, 3.81 mm pitch, 10-pos., separable for other numbers of positions (minimum: 2-pos.), inserts into the back of the MC header, color: transparent, dimension a: 1.5 mm



Fiber optic - MC 1,5/10-LWL 2,3-3,81 - 1841190

MINI COMBICON fiber optics, 3.81 mm pitch, 10-pos., separable for other numbers of positions (minimum: 2-pos.), inserts into the back of the MC header, color: transparent, dimension a: 2.3 mm



Fiber optic - MC 1,5/10-LWL 4-3,81 - 1841213

MINI COMBICON fiber optics, 3.81 mm pitch, 10-pos., separable for other numbers of positions (minimum: 2-pos.), inserts into the back of the MC header, color: transparent, dimension a: 4 mm



# Printed-circuit board connector - MCV 1,5/ 4-GF-3,81 P26 THR - 1707654

## Accessories

### Labeled terminal marker

Marker card - SK 3,81/2,8:FORTL.ZAHLEN - 0804109



Marker card, Card, white, labeled, horizontal: consecutive numbers 1 ... 10, 11 ... 20, etc. up to 91 ... (99)100, mounting type: adhesive, for terminal block width: 3.81 mm, lettering field size: 3.81 x 2.8 mm

---

### Marker pen

Marker pen - B-STIFT - 1051993



Marker pen, for manual labeling of unprinted Zack strips, smear-proof and waterproof, line thickness 0.5 mm

---

### Terminal marking

Marker card - SK U/2,8 WH:UNBEDRUCKT - 0803883



Marker card, Sheet, white, unlabeled, can be labeled with: PLOTMARK, CMS-P1-PLOTTER, Office printing systems, mounting type: adhesive, for terminal block width: 210 mm, lettering field size: 186 x 2.8 mm, Number of individual labels: 3600

---

## Additional products

Printed-circuit board connector - MC 1,5/ 4-STF-3,81 - 1827729



PCB connector, nominal current: 8 A, rated voltage (III/2): 160 V, nominal cross section: 1.5 mm<sup>2</sup>, number of positions: 4, pitch: 3.81 mm, connection method: Screw connection with tension sleeve, color: green, contact surface: Tin

---

Printed-circuit board connector - MCVR 1,5/ 4-STF-3,81 - 1828362



PCB connector, nominal current: 8 A, rated voltage (III/2): 160 V, nominal cross section: 1.5 mm<sup>2</sup>, number of positions: 4, pitch: 3.81 mm, connection method: Screw connection with tension sleeve, color: green, contact surface: Tin



## Printed-circuit board connector - MCV 1,5/ 4-GF-3,81 P26 THR - 1707654

### Accessories

#### Printed-circuit board connector - MCVW 1,5/ 4-STF-3,81 - 1828511



PCB connector, nominal current: 8 A, rated voltage (III/2): 160 V, nominal cross section: 1.5 mm<sup>2</sup>, number of positions: 4, pitch: 3.81 mm, connection method: Screw connection with tension sleeve, color: green, contact surface: Tin

#### Printed-circuit board connector - FRONT-MC 1,5/ 4-STF-3,81 - 1850877



PCB connector, nominal current: 8 A, rated voltage (III/2): 160 V, nominal cross section: 1.5 mm<sup>2</sup>, number of positions: 4, pitch: 3.81 mm, connection method: Front screw connection, color: green, contact surface: Tin

#### Printed-circuit board connector - FK-MCP 1,5/ 4-STF-3,81 - 1851258



PCB connector, nominal current: 8 A, rated voltage (III/2): 160 V, nominal cross section: 1.5 mm<sup>2</sup>, number of positions: 4, pitch: 3.81 mm, connection method: Push-in spring connection, color: green, contact surface: Tin

#### Printed-circuit board connector - MCC 1/ 4-STZF-3,81 - 1852383



PCB connector, nominal current: 8 A, rated voltage (III/2): 160 V, nominal cross section: 1 mm<sup>2</sup>, number of positions: 4, pitch: 3.81 mm, connection method: Crimp connection, color: green, Corresponding female crimp contacts with current [A] and conductor cross section range [mm<sup>2</sup>] data: 5A/MCC-MT 0,2-0,35 (1859988); 8A/MCC-MT 0,5-1,0 (1859991)

#### Printed-circuit board connector - QC 0,5/ 4-STF-3,81 - 1897568



PCB connector, nominal current: 6 A, rated voltage (III/2): 200 V, nominal cross section: 0.5 mm<sup>2</sup>, number of positions: 4, pitch: 3.81 mm, connection method: Displacement connection, color: green, contact surface: Tin

Phoenix Contact 2020 © - all rights reserved  
<http://www.phoenixcontact.com>

PHOENIX CONTACT GmbH & Co. KG  
Flachmarktstr. 8  
32825 Blomberg  
Germany  
Tel. +49 5235 300  
Fax +49 5235 3 41200  
<http://www.phoenixcontact.com>

## X-ON Electronics

Largest Supplier of Electrical and Electronic Components

*Click to view similar products for [Pluggable Terminal Blocks](#) category:*

*Click to view products by [Phoenix Contact](#) manufacturer:*

Other Similar products are found below :

[57.510.0053](#) [MC 1.5/ 6-ST-3.5 GY AU](#) [734-104](#) [734-302](#) [8-141-P](#) [8426620000](#) [860505](#) [860810](#) [GBPACX-12](#) [93.731.4953.0](#) [PV05-5,08-K](#)  
[PVP02-5,00](#) [PVP03-3,50](#) [PVP04-3,50](#) [PVS02-5,00](#) [1-1986160-3](#) [1377680000](#) [1531000000](#) [1546228-5](#) [ELFH16150](#) [ELFP03110](#)  
[ELFP10210](#) [ELFT06250](#) [ELVP03100](#) [1700101](#) [1700410](#) [1700425](#) [1702246](#) [1705229](#) [1710175](#) [1714537](#) [1717806](#) [1719600](#) [1728941](#)  
[1734692](#) [1734795](#) [1736036](#) [1740194](#) [1740291](#) [1740628](#) [1740990](#) [1746952](#) [1750207](#) [1752441](#) [1752865](#) [1754115](#) [1754144](#) [1756913](#)  
[1760051](#) [1760336](#)