

Printed-circuit board connector - IPC 5/ 7-GFU-7,62 - 1708763

Please be informed that the data shown in this PDF Document is generated from our Online Catalog. Please find the complete data in the user's documentation. Our General Terms of Use for Downloads are valid (<http://phoenixcontact.com/download>)



PCB headers, nominal current: 41 A, rated voltage (III/2): 630 V, nominal cross section: 6 mm², number of positions: 7, pitch: 7.62 mm, color: green, contact surface: Tin, mounting: Wave soldering, pin layout: Linear pinning, solder pin [P]: 5 mm

The figure shows a 5-pos. version of the product

Your advantages

- ✓ Well-known mounting principle allows worldwide use
- ✓ Maximum flexibility when it comes to device design – one header for connectors with different connection technologies
- ✓ Inverted header with socket contacts for touch-proof device outputs or PCB/PCB connections
- ✓ Screwable flange for superior mechanical stability
- ✓ Integrated double steel spring provides additional safety in the event of temperature and power fluctuations



Key Commercial Data

Packing unit	50 pc
GTIN	
GTIN	4046356089685

Technical data

Item properties

Brief article description	Feed-through header
Plug-in system	POWER COMBICON 5
Type of contact	Female connector
Range of articles	IPC 5/...-GFU
Pitch	7.62 mm
Number of positions	7
Mounting type	Wave soldering
Pin layout	Linear pinning
Locking	Threaded flange
Number of levels	1

Printed-circuit board connector - IPC 5/ 7-GFU-7,62 - 1708763

Technical data

Item properties

Number of connections	7
Number of potentials	7

Electrical parameters

Nominal current	41 A
Nom. voltage	630 V
Rated voltage	630 V
Rated voltage (III/2)	630 V
Rated voltage (II/2)	1000 V
Rated surge voltage (III/3)	6 kV
Rated surge voltage (III/2)	6 kV
Rated surge voltage (II/2)	6 kV

Material data - contact

Note	WEEE/RoHS-compliant, free of whiskers according to IEC 60068-2-82/ JEDEC JESD 201
Contact material	Cu alloy
Surface characteristics	hot-dip tin-plated
Metal surface contact area (top layer)	Tin (4 - 8 µm Sn)
Metal surface soldering area (top layer)	Tin (4 - 8 µm Sn)

Material data - housing

Housing color	green (6021)
Insulating material	PA
Insulating material group	I
CTI according to IEC 60112	600
Flammability rating according to UL 94	V0
Glow wire flammability index GWFI according to EN 60695-2-12	850
Glow wire ignition temperature GWIT according to EN 60695-2-13	775
Temperature for the ball pressure test according to EN 60695-10-2	125 °C

Dimensions for the product

Length [l]	30.1 mm
Width [w]	53.34 mm
Height [h]	17.8 mm
Pitch	7.62 mm
Height (without solder pin)	12.8 mm
Solder pin [P]	5 mm
Pin spacing	7.62 mm
Pin dimensions	1.2 x 0.8 mm

Dimensions for PCB design

Hole diameter	1.3 mm
Pin spacing	7.62 mm

Printed-circuit board connector - IPC 5/ 7-GFU-7,62 - 1708763

Technical data

Packaging information

Type of packaging	packed in cardboard
Pieces per package	50
Denomination packing units	Pcs.

Standards and Regulations

Connection in acc. with standard	EN-VDE
	CUL
Flammability rating according to UL 94	V0

Environmental Product Compliance

China RoHS	Environmentally friendly use period: unlimited = EFUP-e
	No hazardous substances above threshold values

Drawings

Drilling diagram

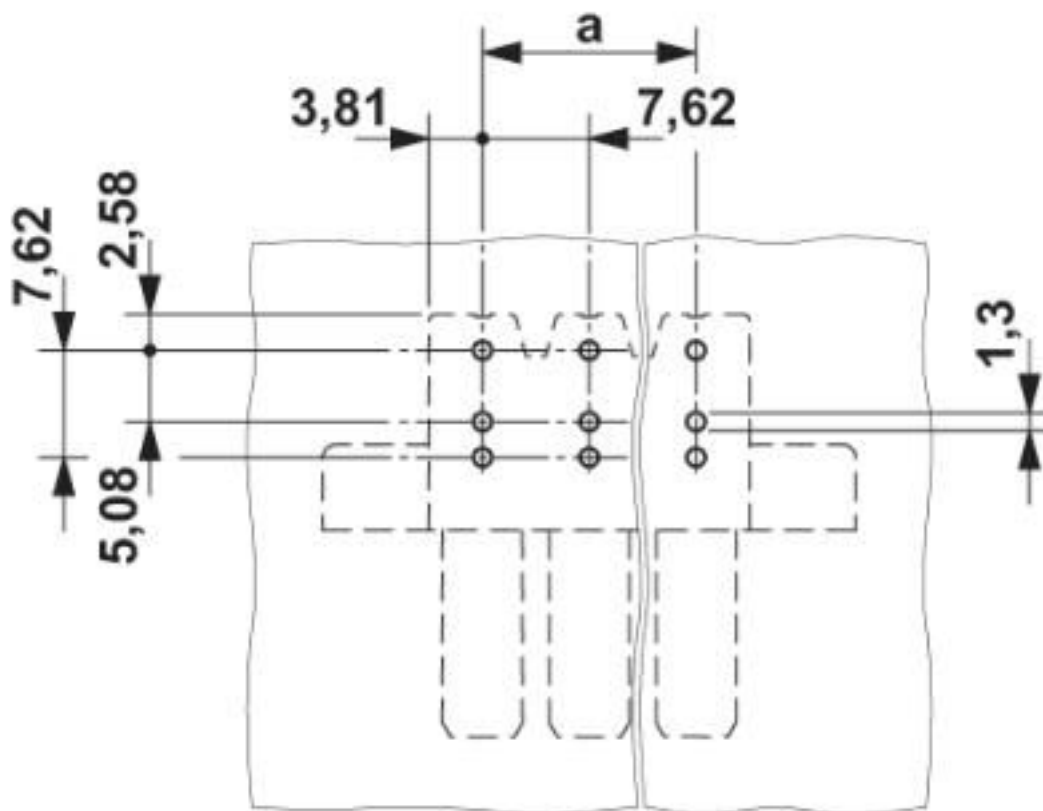

Classifications

eCl@ss

eCl@ss 10.0.1	27440402
---------------	----------

Printed-circuit board connector - IPC 5/ 7-GFU-7,62 - 1708763

Classifications

eCl@ss

eCl@ss 4.0	27260700
eCl@ss 4.1	27260700
eCl@ss 5.0	27260700
eCl@ss 5.1	27260700
eCl@ss 6.0	27260700
eCl@ss 7.0	27440402
eCl@ss 8.0	27440402
eCl@ss 9.0	27440402

ETIM

ETIM 3.0	EC001121
ETIM 4.0	EC002637
ETIM 5.0	EC002637
ETIM 6.0	EC002637
ETIM 7.0	EC002637

UNSPSC

UNSPSC 6.01	30211810
UNSPSC 7.0901	39121409
UNSPSC 11	39121409
UNSPSC 12.01	39121409
UNSPSC 13.2	39121409
UNSPSC 18.0	39121409
UNSPSC 19.0	39121409
UNSPSC 20.0	39121409
UNSPSC 21.0	39121409

Approvals

Approvals

Approvals

EAC / cULus Recognized

Ex Approvals

Approval details

Printed-circuit board connector - IPC 5/ 7-GFU-7,62 - 1708763

Approvals

EAC		B.01687
-----	--	---------

cULus Recognized		http://database.ul.com/cgi-bin/XYV/template/LISEXT/1FRAME/index.htm	E60425-19920722
------------------	--	---	-----------------

	B	C	D
Nominal voltage UN	300 V	300 V	600 V
Nominal current IN	41 A	41 A	5 A

Accessories

Accessories

Labeled terminal marker

Marker card - SK 7,62/3,8:FORTL.ZAHLEN - 0804549

Marker card, Card, white, labeled, horizontal: consecutive numbers 1 ... 10, 11 ... 20, etc. up to 91 ... 100, mounting type: adhesive, for terminal block width: 7.62 mm, lettering field size: 7.62 x 3.8 mm



Marker card - SK 3,8 REEL P7,62 WH CUS - 0825128

Marker card, Card, can be ordered: by card, white, labeled according to customer specifications, mounting type: adhesive, for terminal block width: 7.62 mm, lettering field size: continuous x 3.8#mm



Terminal marking

Marker card - SK U/3,8 WH:UNBEDRUCKT - 0803906

Marker card, Sheet, white, unlabeled, can be labeled with: PLOTMARK, CMS-P1-PLOTTER, Office printing systems, mounting type: adhesive, for terminal block width: 210 mm, lettering field size: 186 x 3.8 mm, Number of individual labels: 1440



Printed-circuit board connector - IPC 5/ 7-GFU-7,62 - 1708763

Accessories

Marker strip - SK 3,8 WH:REEL - 0805218



Marker strip, Roll, white, unlabeled, can be labeled with: THERMOMARK ROLL 2.0, THERMOMARK ROLL, THERMOMARK ROLL X1, THERMOMARK ROLLMASTER 300/600, THERMOMARK X1.2, mounting type: adhesive, for terminal block width: 90000 mm, lettering field size: continuous x 3.8#mm, Number of individual labels: 210000

Additional products

Printed-circuit board connector - IPC 5/ 7-STF-7,62 - 1709209



PCB connector, nominal current: 41 A, rated voltage (III/2): 1000 V, nominal cross section: 6 mm², number of positions: 7, pitch: 7.62 mm, connection method: Screw connection with tension sleeve, color: green, contact surface: Tin

Printed-circuit board connector - ISPC 5/ 7-STF-7,62 - 1749023



PCB connector, nominal current: 41 A, rated voltage (III/2): 1000 V, nominal cross section: 6 mm², number of positions: 7, pitch: 7.62 mm, connection method: Push-in spring connection, color: green, contact surface: Tin

Phoenix Contact 2020 © - all rights reserved
<http://www.phoenixcontact.com>

PHOENIX CONTACT GmbH & Co. KG
Flachsmarktstr. 8
32825 Blomberg
Germany
Tel. +49 5235 300
Fax +49 5235 3 41200
<http://www.phoenixcontact.com>

X-ON Electronics

Largest Supplier of Electrical and Electronic Components

Click to view similar products for [Pluggable Terminal Blocks](#) category:

Click to view products by [Phoenix Contact](#) manufacturer:

Other Similar products are found below :

[57.510.0053](#) [MC 1.5/ 6-ST-3.5 GY AU](#) [734-104](#) [734-302](#) [8-141-P](#) [8426620000](#) [860505](#) [860810](#) [GBPACX-12](#) [93.731.4953.0](#) [PV05-5,08-K](#)
[PVP02-5,00](#) [PVP03-3,50](#) [PVP04-3,50](#) [PVS02-5,00](#) [1-1986160-3](#) [1377680000](#) [1531000000](#) [1546228-5](#) [ELFH16150](#) [ELFP03110](#)
[ELFP10210](#) [ELFT06250](#) [ELVP03100](#) [1700101](#) [1700410](#) [1700425](#) [1702246](#) [1705229](#) [1710175](#) [1714537](#) [1717806](#) [1719600](#) [1728941](#)
[1734692](#) [1734795](#) [1736036](#) [1740194](#) [1740291](#) [1740628](#) [1740990](#) [1746952](#) [1750207](#) [1752441](#) [1752865](#) [1754115](#) [1754144](#) [1756913](#)
[1760051](#) [1760336](#)