

# Printed-circuit board connector - DFK-PCV 5/ 8-G-7,62 - 1716344

Please be informed that the data shown in this PDF Document is generated from our Online Catalog. Please find the complete data in the user's documentation. Our General Terms of Use for Downloads are valid (<http://phoenixcontact.com/download>)

Feed-through header, nominal current: 41 A, rated voltage (III/2): 630 V, nominal cross section: 6 mm<sup>2</sup>, number of positions: 8, pitch: 7.62 mm, color: green, contact surface: Tin, mounting: Wave soldering, pin layout: Linear pinning, solder pin [P]: 5 mm



The figure shows a 5-pos. version of the product

## Your advantages

- Well-known mounting principle allows worldwide use
- Flange system enables secure fixing to the housing panel by means of tool-free snap-in locking or screws



## Key Commercial Data

Packing unit	10 pc
GTIN	
GTIN	4046356136969

## Technical data

### Item properties

Brief article description	Feed-through header
Plug-in system	POWER COMBICON 5
Type of contact	Male connector
Range of articles	DFK-PCV 5/..-G
Pitch	7.62 mm
Number of positions	8
Mounting type	Wave soldering
Pin layout	Linear pinning
Locking	without
Number of levels	1
Number of connections	8
Number of potentials	8

# Printed-circuit board connector - DFK-PCV 5/ 8-G-7,62 - 1716344

## Technical data

### Electrical parameters

Nominal current	41 A
Nom. voltage	630 V
Rated voltage	500 V
Rated voltage (III/2)	630 V
Rated voltage (II/2)	800 V
Rated surge voltage (III/3)	6 kV
Rated surge voltage (III/2)	6 kV
Rated surge voltage (II/2)	6 kV

### Material data - contact

Note	WEEE/RoHS-compliant, free of whiskers according to IEC 60068-2-82/ JEDEC JESD 201
Contact material	Cu alloy
Metal surface contact area (top layer)	Tin (4 - 8 µm Sn)
Metal surface soldering area (top layer)	Tin (4 - 8 µm Sn)

### Material data - housing

Housing color	green (6021)
Insulating material	PA
Insulating material group	I
CTI according to IEC 60112	600
Flammability rating according to UL 94	V0
Glow wire flammability index GWFI according to EN 60695-2-12	850
Glow wire ignition temperature GWIT according to EN 60695-2-13	775
Temperature for the ball pressure test according to EN 60695-10-2	125 °C

### Dimensions for the product

Length [ l ]	19.54 mm
Width [ w ]	86.46 mm
Height [ h ]	46.65 mm
Pitch	7.62 mm
Height (without solder pin)	29.25 mm
Solder pin [P]	5 mm
Pin spacing	7.62 mm
Pin dimensions	0.8 x 1 mm

### Dimensions for PCB design

Hole diameter	1.3 mm
Pin spacing	7.62 mm

### Packaging information

Type of packaging	packed in cardboard
Pieces per package	10
Denomination packing units	Pcs.

# Printed-circuit board connector - DFK-PCV 5/ 8-G-7,62 - 1716344

## Technical data

### Standards and Regulations

Connection in acc. with standard	EN-VDE
Flammability rating according to UL 94	V0

### Environmental Product Compliance

China RoHS	Environmentally friendly use period: unlimited = EFUP-e
	No hazardous substances above threshold values

## Drawings

Drilling diagram

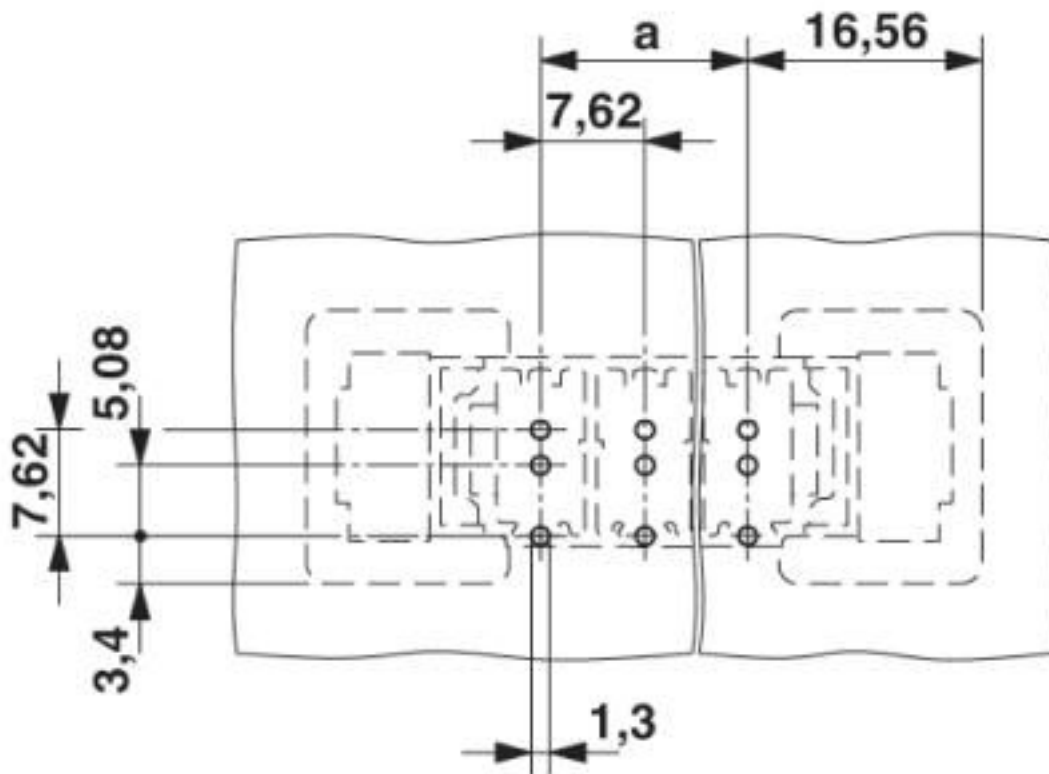

# Printed-circuit board connector - DFK-PCV 5/ 8-G-7,62 - 1716344

Dimensional drawing

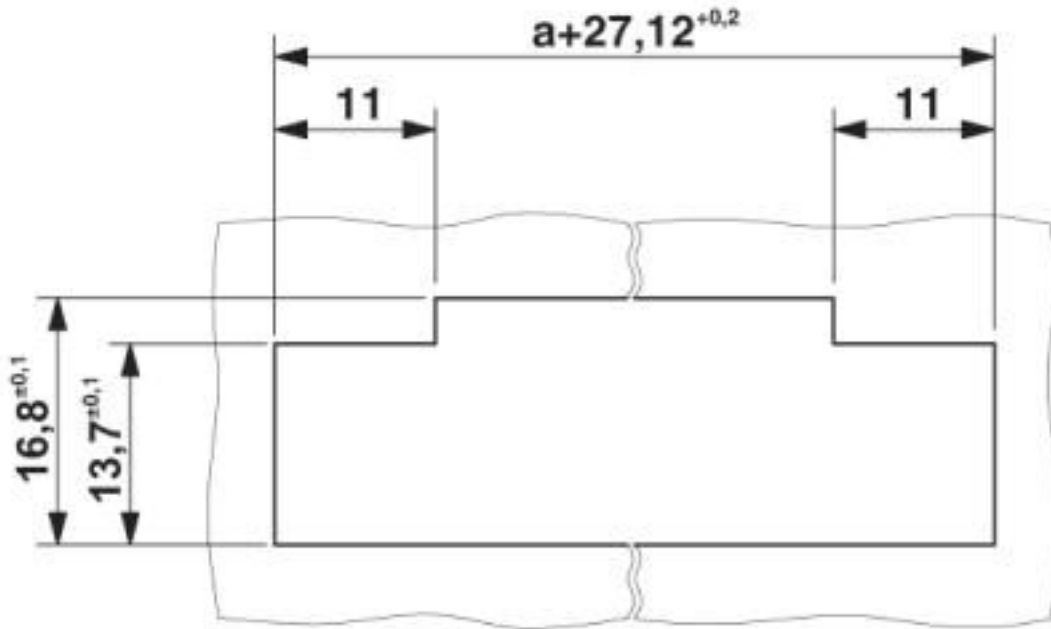

Sheet metal cutout for snap-on.

# Printed-circuit board connector - DFK-PCV 5/ 8-G-7,62 - 1716344

Dimensional drawing

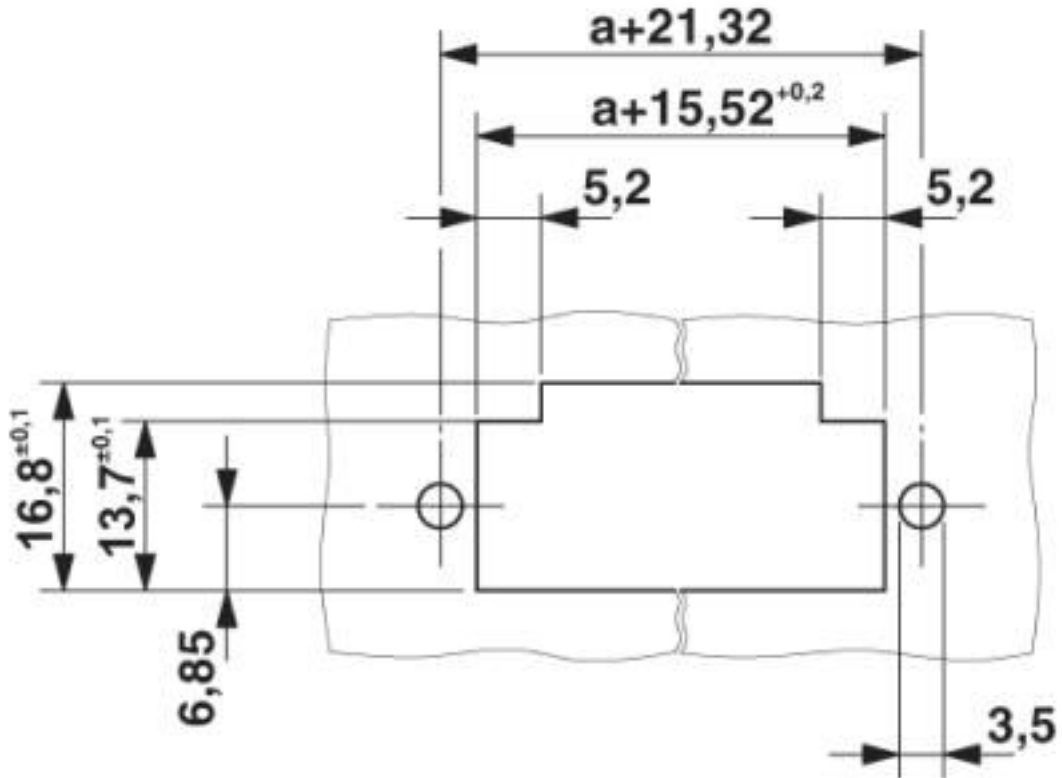

Sheet metal cutout for screw connection.

# Printed-circuit board connector - DFK-PCV 5/ 8-G-7,62 - 1716344

Dimensional drawing

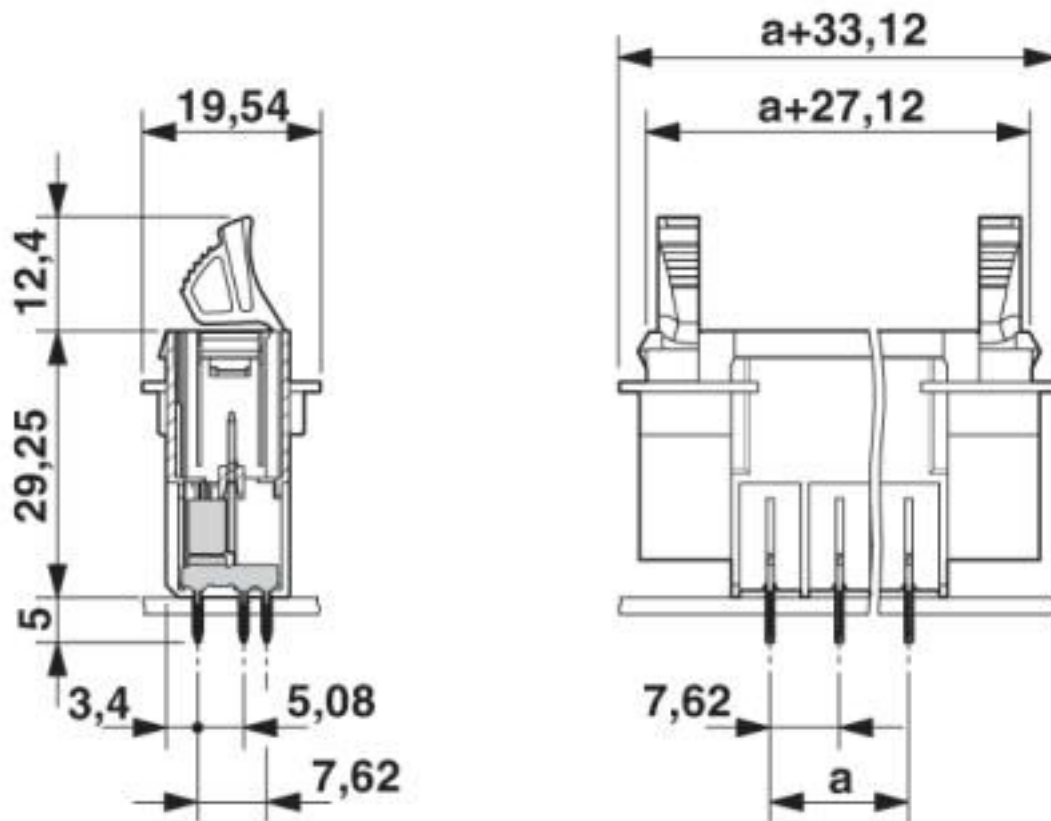

## Classifications

eCl@ss

eCl@ss 10.0.1	27440402
eCl@ss 4.0	27260700
eCl@ss 4.1	27260700
eCl@ss 5.0	27260700
eCl@ss 5.1	27260700
eCl@ss 6.0	27260700
eCl@ss 7.0	27440402
eCl@ss 8.0	27440402
eCl@ss 9.0	27440402

ETIM

ETIM 3.0	EC001121
ETIM 4.0	EC002637
ETIM 5.0	EC002637
ETIM 6.0	EC002637
ETIM 7.0	EC002637

# Printed-circuit board connector - DFK-PCV 5/ 8-G-7,62 - 1716344

## Classifications

### UNSPSC

UNSPSC 6.01	30211810
UNSPSC 7.0901	39121409
UNSPSC 11	39121409
UNSPSC 12.01	39121409
UNSPSC 13.2	39121409
UNSPSC 18.0	39121409
UNSPSC 19.0	39121409
UNSPSC 20.0	39121409
UNSPSC 21.0	39121409

## Approvals

### Approvals

Approvals

EAC

Ex Approvals

### Approval details

EAC		B.01687
-----	--	---------

## Accessories

### Accessories

#### Coding element

Coding profile - CP-PC RD - 1701967

Coding profile, for plugging into the coding ribs of the plug at a later date, insulating material, color: Red



### Labeled terminal marker

## Printed-circuit board connector - DFK-PCV 5/ 8-G-7,62 - 1716344

### Accessories

Marker card - SK 7,62/3,8:FORTL.ZAHLEN - 0804549



Marker card, Card, white, labeled, horizontal: consecutive numbers 1 ... 10, 11 ... 20, etc. up to 91 ... 100, mounting type: adhesive, for terminal block width: 7.62 mm, lettering field size: 7.62 x 3.8 mm

Marker card - SK 3,8 REEL P7,62 WH CUS - 0825128



Marker card, Card, can be ordered: by card, white, labeled according to customer specifications, mounting type: adhesive, for terminal block width: 7.62 mm, lettering field size: continuous x 3.8#mm

### Mounting material

Accessories - DFK-PC 16-SS - 1705449



Screw set for DFK-PC 16... connectors

### Terminal marking

Marker card - SK U/3,8 WH:UNBEDRUCKT - 0803906



Marker card, Sheet, white, unlabeled, can be labeled with: PLOTMARK, CMS-P1-PLOTTER, Office printing systems, mounting type: adhesive, for terminal block width: 210 mm, lettering field size: 186 x 3.8 mm, Number of individual labels: 1440

Marker strip - SK 3,8 WH:REEL - 0805218



Marker strip, Roll, white, unlabeled, can be labeled with: THERMOMARK ROLL 2.0, THERMOMARK ROLL, THERMOMARK ROLL X1, THERMOMARK ROLLMASTER 300/600, THERMOMARK X1.2, mounting type: adhesive, for terminal block width: 90000 mm, lettering field size: continuous x 3.8#mm, Number of individual labels: 210000

### Additional products



## Printed-circuit board connector - DFK-PCV 5/ 8-G-7,62 - 1716344

### Accessories

#### Printed-circuit board connector - TSPC 5/ 8-ST-7,62 - 1728510



PCB connector, nominal current: 41 A, rated voltage (III/2): 1000 V, nominal cross section: 6 mm<sup>2</sup>, number of positions: 8, pitch: 7.62 mm, connection method: Push-in spring connection, color: green, contact surface: Tin

---

#### Printed-circuit board connector - PC 5/ 8-ST1-7,62 - 1777781



PCB connector, nominal current: 41 A, rated voltage (III/2): 1000 V, nominal cross section: 6 mm<sup>2</sup>, number of positions: 8, pitch: 7.62 mm, connection method: Screw connection with tension sleeve, color: green, contact surface: Tin

---

#### Printed-circuit board connector - SPC 5/ 8-ST-7,62 - 1996074



PCB connector, nominal current: 41 A, rated voltage (III/2): 1000 V, nominal cross section: 6 mm<sup>2</sup>, number of positions: 8, pitch: 7.62 mm, connection method: Push-in spring connection, color: green, contact surface: Tin

---

#### Printed-circuit board connector - PC 5/ 8-STCL1-7,62 - 1778120



PCB connector, nominal current: 41 A, rated voltage (III/2): 1000 V, nominal cross section: 6 mm<sup>2</sup>, number of positions: 8, pitch: 7.62 mm, connection method: Screw connection with tension sleeve, color: green, contact surface: Tin

---

#### Printed-circuit board connector - SPC 5/ 8-STCL-7,62 - 1718546



PCB connector, nominal current: 41 A, rated voltage (III/2): 1000 V, nominal cross section: 6 mm<sup>2</sup>, number of positions: 8, pitch: 7.62 mm, connection method: Push-in spring connection, color: green, contact surface: Tin

---

## Printed-circuit board connector - DFK-PCV 5/ 8-G-7,62 - 1716344

### Accessories

Printed-circuit board connector - TSPC 5/ 8-STCL-7,62 - 1765476



PCB connector, nominal current: 41 A, rated voltage (III/2): 1000 V, nominal cross section: 6 mm<sup>2</sup>, number of positions: 8, pitch: 7.62 mm, connection method: Push-in spring connection, color: green, contact surface: Tin

---

Phoenix Contact 2020 © - all rights reserved  
<http://www.phoenixcontact.com>

PHOENIX CONTACT GmbH & Co. KG  
Flachsmarktstr. 8  
32825 Blomberg  
Germany  
Tel. +49 5235 300  
Fax +49 5235 3 41200  
<http://www.phoenixcontact.com>

## X-ON Electronics

Largest Supplier of Electrical and Electronic Components

*Click to view similar products for [Pluggable Terminal Blocks](#) category:*

*Click to view products by [Phoenix Contact](#) manufacturer:*

Other Similar products are found below :

[57.510.0053](#) [MC 1.5/ 6-ST-3.5 GY AU](#) [734-104](#) [734-302](#) [8-141-P](#) [8426620000](#) [860505](#) [860810](#) [GBPACX-12](#) [93.731.4953.0](#) [PV05-5,08-K](#)  
[PVP02-5,00](#) [PVP03-3,50](#) [PVP04-3,50](#) [PVS02-5,00](#) [1-1986160-3](#) [1377680000](#) [1531000000](#) [1546228-5](#) [ELFH16150](#) [ELFP03110](#)  
[ELFP10210](#) [ELFT06250](#) [ELVP03100](#) [1700101](#) [1700410](#) [1700425](#) [1702246](#) [1705229](#) [1710175](#) [1714537](#) [1717806](#) [1719600](#) [1728941](#)  
[1734692](#) [1734795](#) [1736036](#) [1740194](#) [1740291](#) [1740628](#) [1740990](#) [1746952](#) [1750207](#) [1752441](#) [1752865](#) [1754115](#) [1754144](#) [1756913](#)  
[1760051](#) [1760336](#)