

Feed-through plug - DFK-PC 5/12-STF-SH-7,62 - 1716823

Please be informed that the data shown in this PDF Document is generated from our Online Catalog. Please find the complete data in the user's documentation. Our General Terms of Use for Downloads are valid (<http://phoenixcontact.com/download>)



Feed-through connector, nominal current: 41 A, rated voltage (III/2): 1000 V, nominal cross section: 6 mm², number of positions: 12, pitch: 7.62 mm, connection method: Screw connection with tension sleeve, color: green, contact surface: Tin

Your advantages

- ✓ Well-known connection principle allows worldwide use
- ✓ Low temperature rise, thanks to maximum contact force
- ✓ Allows connection of two conductors
- ✓ Flange system enables secure fixing to the housing panel by means of tool-free snap-in locking or screws
- ✓ Shroud for professional EMC shield feed-through on the inside of the device
- ✓ Screwable flange for superior mechanical stability



Key Commercial Data

Packing unit	10 pc
GTIN	 4 046356 137447
GTIN	4046356137447

Technical data

Item properties

Brief article description	Feed-through plug
Plug-in system	POWER COMBICON 5
Type of contact	Male connector
Range of articles	DFK-PC 5/...-STF-SH
Pitch	7.62 mm
Number of positions	12
Connection method	Screw connection with tension sleeve
Screw thread	M3
Locking	Screw flange
Number of levels	1

Feed-through plug - DFK-PC 5/12-STF-SH-7,62 - 1716823

Technical data

Item properties

Number of connections	12
Number of potentials	12

Electrical parameters

Nominal current	41 A
Nom. voltage	1000 V
Rated voltage	630 V
Rated voltage (III/2)	1000 V
Rated voltage (II/2)	1000 V
Rated surge voltage (III/3)	8 kV
Rated surge voltage (III/2)	8 kV
Rated surge voltage (II/2)	6 kV

Connection capacity

Connection method	Screw connection with tension sleeve
pluggable	Yes
Conductor cross section solid	0.2 mm ² ... 10 mm ²
Conductor cross section flexible	0.2 mm ² ... 6 mm ²
Conductor cross section AWG / kcmil	24 ... 10
Conductor cross section flexible, with ferrule without plastic sleeve	0.25 mm ² ... 6 mm ²
Conductor cross section, flexible, with ferrule, with plastic sleeve	0.25 mm ² ... 4 mm ²
2 conductors with same cross section, solid	0.2 mm ² ... 2.5 mm ²
2 conductors with same cross section, flexible	0.2 mm ² ... 4 mm ²
2 conductors with same cross section, flexible, with ferrule without plastic sleeve	0.25 mm ² ... 1.5 mm ²
2 conductors with the same cross section, flexible, with TWIN ferrule with plastic sleeve	0.25 mm ² ... 2.5 mm ²
Stripping length	10 mm
Torque	0.7 Nm ... 0.8 Nm

Flange specifications

Type of locking	Screw locking
Mounting flange	Screw flange

Material data - contact

Note	WEEE/RoHS-compliant, free of whiskers according to IEC 60068-2-82/ JEDEC JESD 201
Contact material	Cu alloy
Surface characteristics	hot-dip tin-plated
Metal surface terminal point (top layer)	Tin (4 - 8 µm Sn)
Metal surface contact area (top layer)	Tin (4 - 8 µm Sn)

Material data - housing

Housing color	green (6021)
---------------	--------------

Feed-through plug - DFK-PC 5/12-STF-SH-7,62 - 1716823

Technical data

Material data - housing

Insulating material	PA
Insulating material group	I
CTI according to IEC 60112	600
Flammability rating according to UL 94	V0
Glow wire flammability index GWFI according to EN 60695-2-12	850
Glow wire ignition temperature GWIT according to EN 60695-2-13	775
Temperature for the ball pressure test according to EN 60695-10-2	125 °C

Dimensions for the product

Length [l]	48.95 mm
Width [w]	126.06 mm
Height [h]	26.24 mm
Pitch	7.62 mm

Packaging information

Type of packaging	packed in cardboard
Pieces per package	10
Denomination packing units	Pcs.

Ambient conditions

Ambient temperature (storage/transport)	-40 °C ... 70 °C
Ambient temperature (assembly)	-5 °C ... 100 °C
Ambient temperature (operation)	-40 °C ... 100 °C (dependent on the derating curve)

Air clearances and creepage distances

Clearances and creepage distances	IEC 60664-1:2007-04
Specification	IEC 60664-1:2007-04
Minimum clearance - inhomogeneous field (III/3)	8 mm
Minimum clearance - inhomogeneous field (III/2)	8 mm
Minimum clearance - inhomogeneous field (II/2)	5.5 mm
Minimum creepage distance value (III/3)	8 mm
Minimum creepage distance value (III/2)	5 mm
Minimum creepage distance value (II/2)	5 mm

Environmental Product Compliance

REACH SVHC	Lead 7439-92-1
China RoHS	Environmentally Friendly Use Period = 50 years
	For details about hazardous substances go to tab "Downloads", Category "Manufacturer's declaration"

Drawings

Feed-through plug - DFK-PC 5/12-STF-SH-7,62 - 1716823

Drilling diagram

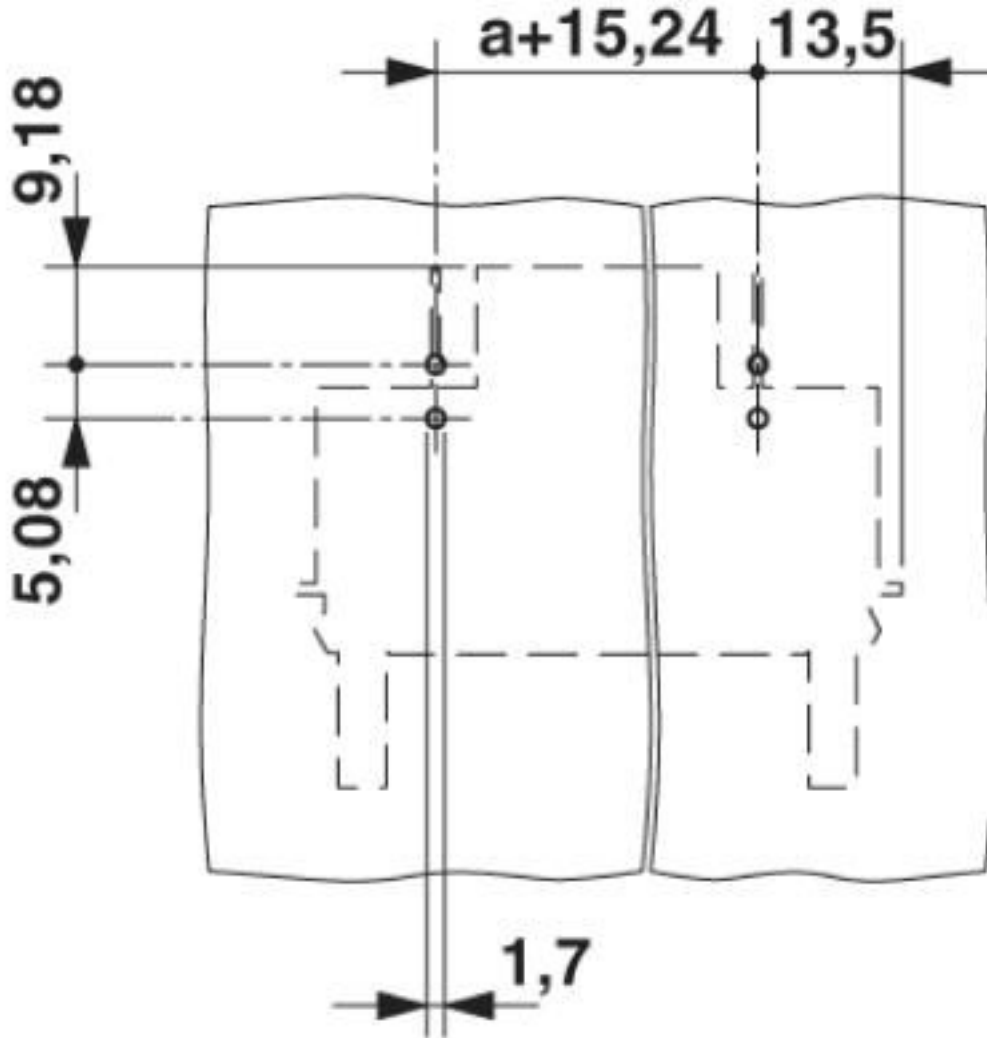

Feed-through plug - DFK-PC 5/12-STF-SH-7,62 - 1716823

Diagram

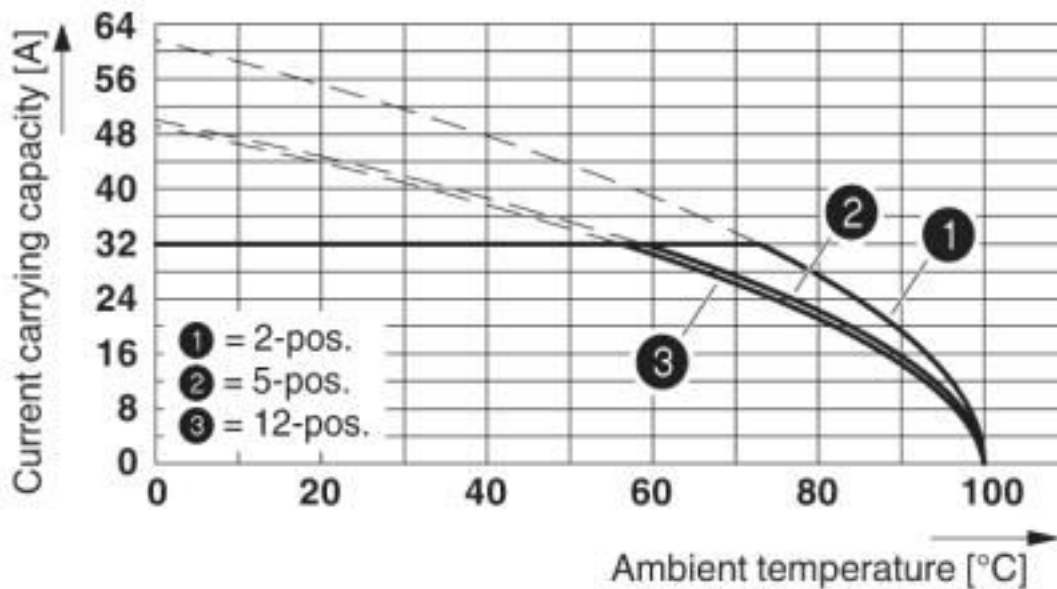

Derating curve for: DFK-PC 5/...-ST-7,62 with PC 5/...-ST-7,62
Conductor cross section = 6 mm²

Diagram

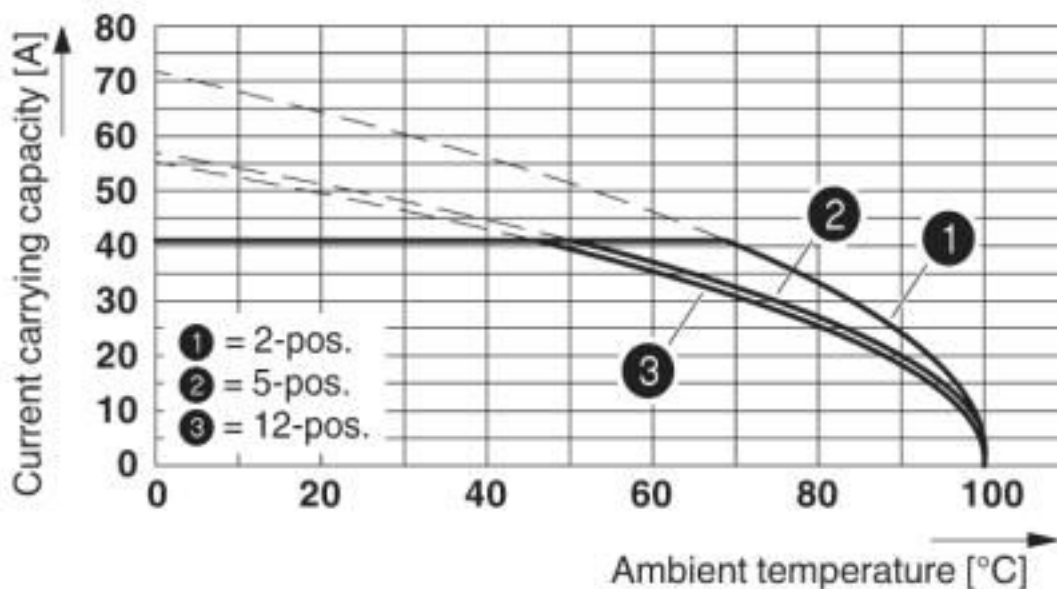

Derating curve for: DFK-PC 5/...-ST-7,62 with PC 5/...-ST-7,62
Conductor cross section = 10 mm²

Feed-through plug - DFK-PC 5/12-STF-SH-7,62 - 1716823

Dimensional drawing

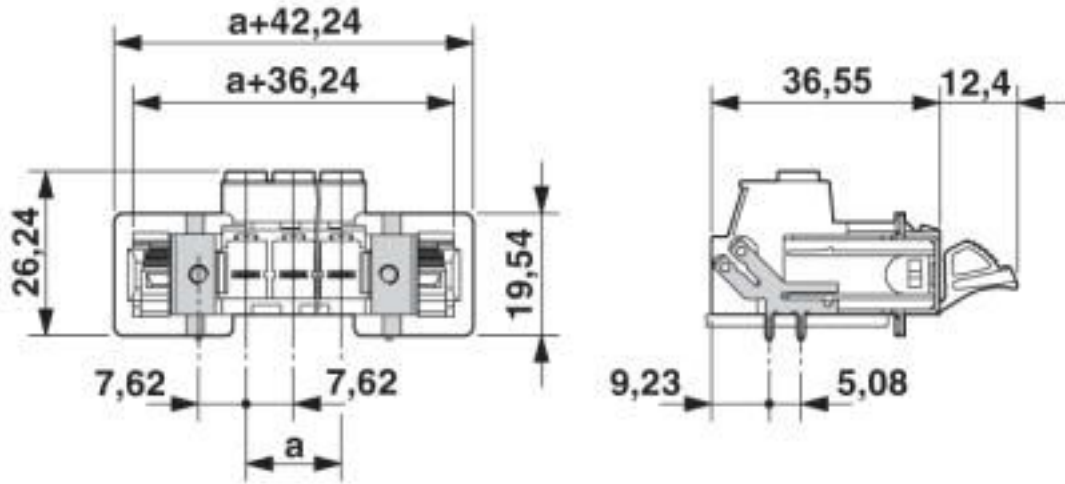

Dimensional drawing

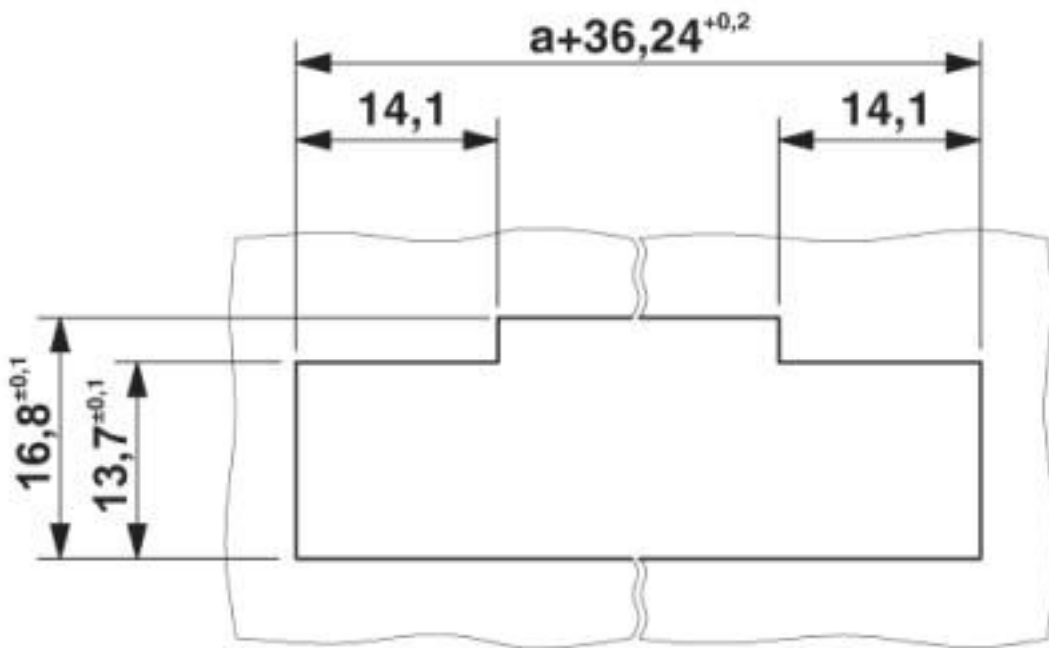

Sheet metal cutout for snap-on.

Feed-through plug - DFK-PC 5/12-STF-SH-7,62 - 1716823

Dimensional drawing

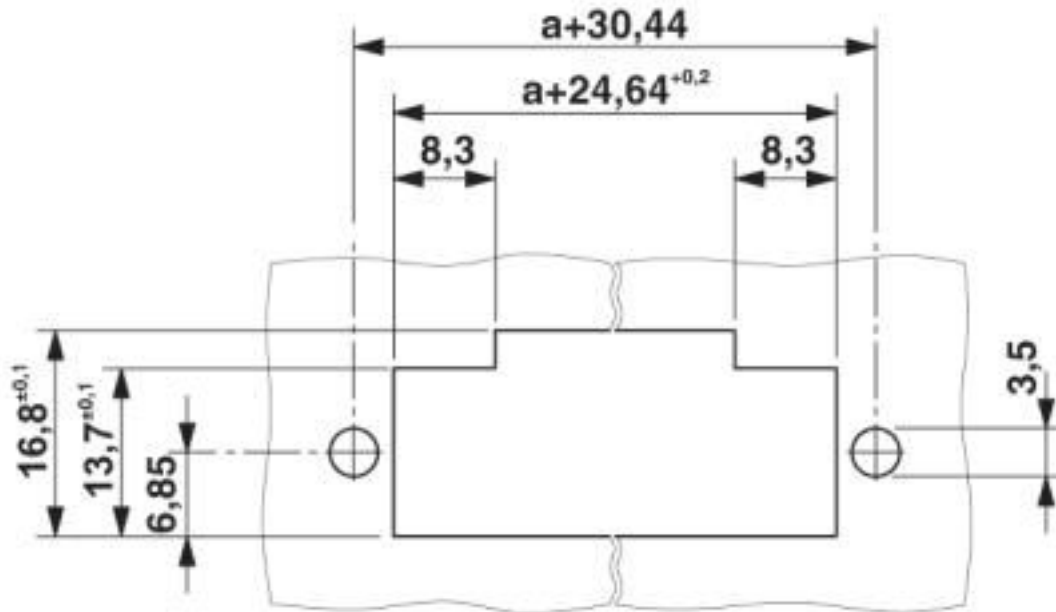

Sheet metal cutout for screw connection.

Classifications

eCl@ss

eCl@ss 10.0.1	27440309
eCl@ss 4.0	27260700
eCl@ss 4.1	27260700
eCl@ss 5.0	27260700
eCl@ss 5.1	27260700
eCl@ss 6.0	27260700
eCl@ss 7.0	27440309
eCl@ss 8.0	27440309
eCl@ss 9.0	27440309

ETIM

ETIM 3.0	EC001121
ETIM 4.0	EC002638
ETIM 5.0	EC002637
ETIM 6.0	EC002638
ETIM 7.0	EC002638

UNSPSC

UNSPSC 6.01	30211810
UNSPSC 7.0901	39121409
UNSPSC 11	39121409

Feed-through plug - DFK-PC 5/12-STF-SH-7,62 - 1716823

Classifications

UNSPSC

UNSPSC 12.01	39121409
UNSPSC 13.2	39121409
UNSPSC 18.0	39121409
UNSPSC 19.0	39121409
UNSPSC 20.0	39121409
UNSPSC 21.0	39121409

Approvals

Approvals

Approvals

EAC / cULus Recognized

Ex Approvals

Approval details

EAC		B.01687
-----	--	---------

cULus Recognized		http://database.ul.com/cgi-bin/XYV/template/LISEXT/1FRAME/index.htm	E60425-19920722
------------------	--	---	-----------------

	B	C
Nominal voltage UN	600 V	600 V
Nominal current IN	41 A	41 A
mm ² /AWG/kcmil	24-8	24-8

Accessories

Accessories

Coding element

Coding profile - CP-PC RD - 1701967

Coding profile, for plugging into the coding ribs of the plug at a later date, insulating material, color: Red



Feed-through plug - DFK-PC 5/12-STF-SH-7,62 - 1716823

Accessories

Connector

Connector - C-SCF 2,5/6,3X0,8 - 3240159



Slip-on sleeve, non-insulated, 1.5 ... 2.5 mm², 6.3 x 0.8

Connector - C-SCF 6/6,3X0,8 - 3240160



Slip-on sleeve, non-insulated, 4 ... 6 mm², 6.3 x 0.8

Connector - C-SCF 1,5/6,3X0,8 - 3240156



Slip-on sleeve, non-insulated, 0.5 ... 1.5 mm², 6.3 x 0.8

Connector - C-SCFI 6/6,3X0,8 - 3240056



Slip-on sleeve, yellow, 4 ... 6 mm², 6.3 x 0.8

Connector - C-SCFI 1,5/6,3X0,8 - 3240052



Slip-on sleeve, red, 0.5 ... 1.5 mm², 6.3 x 0.8

Feed-through plug - DFK-PC 5/12-STF-SH-7,62 - 1716823

Accessories

Connector - C-SCFFI 2,5/6,3X0,8 - 3240547



Slip-on sleeve, fully isolated, blue, 1.5 ... 2.5 mm², for plug 6.3 x 0.8 mm

Connector - C-SCFI 2,5/6,3X0,8 - 3240055



Slip-on sleeve, blue, 1.5 ... 2.5 mm², 6.3 x 0.8

Connector - C-SCFFI 6/6,3X0,8 - 3240541



Slip-on sleeve, fully insulated, yellow, 4 ... 6 mm², for 6.3 x 0.8 mm plugs

Connector - C-SCFFI 1,5/6,3X0,8 - 3240538



Slip-on sleeve, fully isolated, red, 0.5 ... 1.5 mm², for plug 6.3 x 0.8 mm

Connector set

Accessories - DFK-PC MOUNT SET - 1054021

Contains 20 pcs. latch and screw elements for feed-through connectors each

Labeled terminal marker

Feed-through plug - DFK-PC 5/12-STF-SH-7,62 - 1716823

Accessories

Marker card - SK 7,62/3,8:FORTL.ZAHLEN - 0804549



Marker card, Card, white, labeled, horizontal: consecutive numbers 1 ... 10, 11 ... 20, etc. up to 91 ... 100, mounting type: adhesive, for terminal block width: 7.62 mm, lettering field size: 7.62 x 3.8 mm

Marker card - SK 3,8 REEL P7,62 WH CUS - 0825128



Marker card, Card, can be ordered: by card, white, labeled according to customer specifications, mounting type: adhesive, for terminal block width: 7.62 mm, lettering field size: continuous x 3.8#mm

Mounting material

Accessories - DFK-PC 16-SS - 1705449



Screw set for DFK-PC 16... connectors

Screwdriver tools

Philips screwdriver - SZK PZ1 VDE - 1206450



Screwdriver, PZ crosshead, VDE insulated, size: PZ 1 x 80 mm, 2-component grip, with non-slip grip

Terminal marking

Marker card - SK U/3,8 WH:UNBEDRUCKT - 0803906



Marker card, Sheet, white, unlabeled, can be labeled with: PLOTMARK, CMS-P1-PLOTTER, Office printing systems, mounting type: adhesive, for terminal block width: 210 mm, lettering field size: 186 x 3.8 mm, Number of individual labels: 1440

Feed-through plug - DFK-PC 5/12-STF-SH-7,62 - 1716823

Accessories

Marker strip - SK 3,8 WH:REEL - 0805218



Marker strip, Roll, white, unlabeled, can be labeled with: THERMOMARK ROLL 2.0, THERMOMARK ROLL, THERMOMARK ROLL X1, THERMOMARK ROLLMASTER 300/600, THERMOMARK X1.2, mounting type: adhesive, for terminal block width: 90000 mm, lettering field size: continuous x 3.8#mm, Number of individual labels: 210000

Phoenix Contact 2020 © - all rights reserved
<http://www.phoenixcontact.com>

PHOENIX CONTACT GmbH & Co. KG
Flachsmarktstr. 8
32825 Blomberg
Germany
Tel. +49 5235 300
Fax +49 5235 3 41200
<http://www.phoenixcontact.com>

X-ON Electronics

Largest Supplier of Electrical and Electronic Components

Click to view similar products for [Pluggable Terminal Blocks](#) category:

Click to view products by [Phoenix Contact](#) manufacturer:

Other Similar products are found below :

[57.510.0053](#) [MC 1.5/ 6-ST-3.5 GY AU](#) [ET02015000J0G](#) [734-104](#) [734-302](#) [8-141-P](#) [8426620000](#) [860505](#) [860516](#) [860810](#) [GBPACX-12](#)
[93.731.4953.0](#) [PV05-5,08-K](#) [PVP02-5,00](#) [PVP03-3,50](#) [PVP04-3,50](#) [PVS02-5,00](#) [1-1986160-3](#) [1377680000](#) [1531000000](#) [1546228-5](#)
[ELFH16150](#) [ELFP03110](#) [ELFP10210](#) [ELFT06250](#) [ELVP03100](#) [1700101](#) [1700410](#) [1700425](#) [1702246](#) [1705229](#) [1710175](#) [1714537](#) [1717806](#)
[1719600](#) [1728941](#) [1734692](#) [1734795](#) [1736036](#) [1740194](#) [1740291](#) [1740628](#) [1740990](#) [1746952](#) [1750207](#) [1752441](#) [1752865](#) [1754115](#)
[1754144](#) [1756913](#)