

# PCB terminal block - MKDS 1,5/ 7 - 1718948

Please be informed that the data shown in this PDF Document is generated from our Online Catalog. Please find the complete data in the user's documentation. Our General Terms of Use for Downloads are valid (<http://phoenixcontact.com/download>)

PCB terminal block, nominal current: 17.5 A, rated voltage (III/2): 400 V, nominal cross section: 1.5 mm<sup>2</sup>, pitch: 5 mm, number of positions: 7, connection method: Screw connection with tension sleeve, mounting: Wave soldering, conductor/PCB connection direction: 0 °, color: green, Pin layout: Linear pinning, Solder pin [P]: 3.5 mm. The article can be aligned to create different nos. of positions!



The figure shows a 10-position version of the product

## Your advantages

- Well-known connection principle allows worldwide use
- Low temperature rise, thanks to maximum contact force
- Allows connection of two conductors
- The latching on the side enables various numbers of positions to be combined



## Key Commercial Data

Packing unit	50 pc
Minimum order quantity	50 pc
GTIN	
GTIN	4017918231125

## Technical data

### Item properties

Brief article description	PCB terminal block
Range of articles	MKDS 1,5
Pitch	5 mm
Number of positions	7
Connection method	Screw connection with tension sleeve
Drive form screw head	Slotted (L)
Screw thread	M3
Mounting type	Wave soldering
Pin layout	Linear pinning
Number of levels	1

# PCB terminal block - MKDS 1,5/ 7 - 1718948

## Technical data

### Item properties

Number of connections	7
Number of potentials	7

### Electrical parameters

Nominal current	17.5 A
Nom. voltage	400 V
Rated voltage	250 V
Rated voltage (III/2)	400 V
Rated voltage (II/2)	630 V
Rated surge voltage (III/3)	4 kV
Rated surge voltage (III/2)	4 kV
Rated surge voltage (II/2)	4 kV

### Connection capacity

Connection method	Screw connection with tension sleeve
pluggable	Yes
Conductor cross section solid	0.14 mm <sup>2</sup> ... 2.5 mm <sup>2</sup>
Conductor cross section flexible	0.14 mm <sup>2</sup> ... 1.5 mm <sup>2</sup>
Conductor cross section AWG / kcmil	26 ... 14
Conductor cross section flexible, with ferrule without plastic sleeve	0.25 mm <sup>2</sup> ... 1.5 mm <sup>2</sup>
Conductor cross section, flexible, with ferrule, with plastic sleeve	0.25 mm <sup>2</sup> ... 1.5 mm <sup>2</sup>
2 conductors with same cross section, solid	0.14 mm <sup>2</sup> ... 1 mm <sup>2</sup>
2 conductors with same cross section, flexible	0.14 mm <sup>2</sup> ... 0.75 mm <sup>2</sup>
2 conductors with same cross section, flexible, with ferrule without plastic sleeve	0.25 mm <sup>2</sup> ... 0.5 mm <sup>2</sup>
2 conductors with the same cross section, flexible, with TWIN ferrule with plastic sleeve	0.5 mm <sup>2</sup> ... 1 mm <sup>2</sup>
Stripping length	7 mm
Torque	0.5 Nm ... 0.6 Nm

### Material data - contact

Note	WEEE/RoHS-compliant, free of whiskers according to IEC 60068-2-82/ JEDEC JESD 201
Contact material	Cu alloy
Surface characteristics	Tin-plated
Metal surface terminal point (top layer)	Tin (4 - 8 µm Sn)
Metal surface soldering area (top layer)	Tin (4 - 8 µm Sn)

### Material data - housing

Housing color	green (6021)
Insulating material	PA
Insulating material group	I
CTI according to IEC 60112	600
Flammability rating according to UL 94	V0

# PCB terminal block - MKDS 1,5/ 7 - 1718948

## Technical data

### Material data - housing

Glow wire flammability index GWFI according to EN 60695-2-12	850
Glow wire ignition temperature GWIT according to EN 60695-2-13	775
Temperature for the ball pressure test according to EN 60695-10-2	125 °C

### Dimensions for the product

Caption	Schematic representation – for additional information, see product range drawing in the Download Center
Length [ l ]	9.8 mm
Width [ w ]	35 mm
Height [ h ]	17.3 mm
Pitch	5 mm
Height (without solder pin)	13.8 mm
Solder pin [P]	3.5 mm
Pin spacing	5 mm
Pin dimensions	0.9 x 0.9 mm

### Dimensions for PCB design

Hole diameter	1.3 mm
Pin spacing	5 mm

### Packaging information

Type of packaging	packed in cardboard
Pieces per package	50
Denomination packing units	Pcs.

### General product information

Type of note	Note on application
Note	For safe conductor connection, always adhere to a defined tightening torque. Particularly in the case of PCB terminal blocks with two or three positions, the individual solder pin for each contact point cannot compensate for this. That is why the terminal blocks must be supported during conductor connection (held with one hand, support on the housing).

### Ambient conditions

Ambient temperature (storage/transport)	-40 °C ... 70 °C
Ambient temperature (assembly)	-5 °C ... 100 °C
Ambient temperature (operation)	-40 °C ... 100 °C (Depending on the current carrying capacity/derating curve)

### Termination and connection method

Test for conductor damage and slackening	IEC 60998-2-1:1990-04
	Test passed

### Pull-out test

Pull-out test	IEC 60998-2-1:1990-04
	Test passed

# PCB terminal block - MKDS 1,5/ 7 - 1718948

## Technical data

### Pull-out test

Conductor cross section / conductor type / tensile force	0.14 mm <sup>2</sup> / solid / > 10 N
	0.14 mm <sup>2</sup> / flexible / > 10 N
	2.5 mm <sup>2</sup> / solid / > 50 N
	1.5 mm <sup>2</sup> / flexible / > 40 N

### Mechanical tests according to standard

Test specification	IEC 60998-2-1 (in parts)
--------------------	--------------------------

### Electrical tests

Rated current	17.5 A
Conductor cross section	1.5 mm <sup>2</sup>
Rated voltage (III/2)	400 V
Rated surge voltage (III/2)	4 kV

### Air clearances and creepage distances

Clearances and creepage distances	IEC 60947-1:2007-06 + A1:2010-12 + A2:2014-09
Specification	IEC 60947-1:2007-06 + A1:2010-12 + A2:2014-09
Minimum clearance - inhomogeneous field (III/3)	3 mm
Minimum clearance - inhomogeneous field (III/2)	3 mm
Minimum clearance - inhomogeneous field (II/2)	3 mm
Minimum creepage distance value (III/3)	3.2 mm
Minimum creepage distance value (III/2)	3 mm
Minimum creepage distance value (II/2)	3.2 mm
Note on connection cross section	With connected conductor 2.5 mm <sup>2</sup> (solid).

### Temperature-rise test

Specification	IEC 60998-2-1:1990-04
Result	Test passed
Requirement temperature-rise test	Increase in temperature ≤ 45 K

### Current carrying capacity / derating curves

Caption	Type: MKDS 1,5/2 and MKDS 1,5/3 Test as per DIN EN 60512-5-2:2003-01 Reduction factor = 1 No. of positions: 5
Specification	Following IEC 60512-5-2:2002-02
Number of positions	5
Reduction factor	1

### Vibration test

Specification	IEC 60068-2-6:1995-03
Result	Test passed
Frequency	10 - 150 - 10 Hz
Sweep speed	1 octave/min
Amplitude	0.35 mm (10 - 60.1 Hz)

# PCB terminal block - MKDS 1,5/ 7 - 1718948

## Technical data

### Vibration test

Acceleration	5 g (60.1 - 150 Hz)
Test duration per axis	2.5 h

### Resistance to ageing, humidity and penetration of solids

Dry heat	168 h/100°C
Humid heat	48 h/30 °C/92 %

### Insulation resistance

Specification	IEC 60998-2-1:1990-04
Result	Test passed
Insulation resistance, neighboring positions	10 <sup>9</sup> Ω

### Glow-wire test

Specification	IEC 60998-2-1:1990-04
Result	Test passed
Temperature	850 °C
Time of exposure	5 s

### Mechanical strength/tumbling barrel test

Specification	IEC 60998-2-1:1990-04
Height of fall	50 cm
Number of drop cycles	50

### Standards and Regulations

Connection in acc. with standard	EN-VDE
	CSA
Flammability rating according to UL 94	V0

### Environmental Product Compliance

REACH SVHC	Lead 7439-92-1
China RoHS	Environmentally Friendly Use Period = 50 years
	For details about hazardous substances go to tab "Downloads", Category "Manufacturer's declaration"

## Drawings

# PCB terminal block - MKDS 1,5/ 7 - 1718948

Drilling diagram

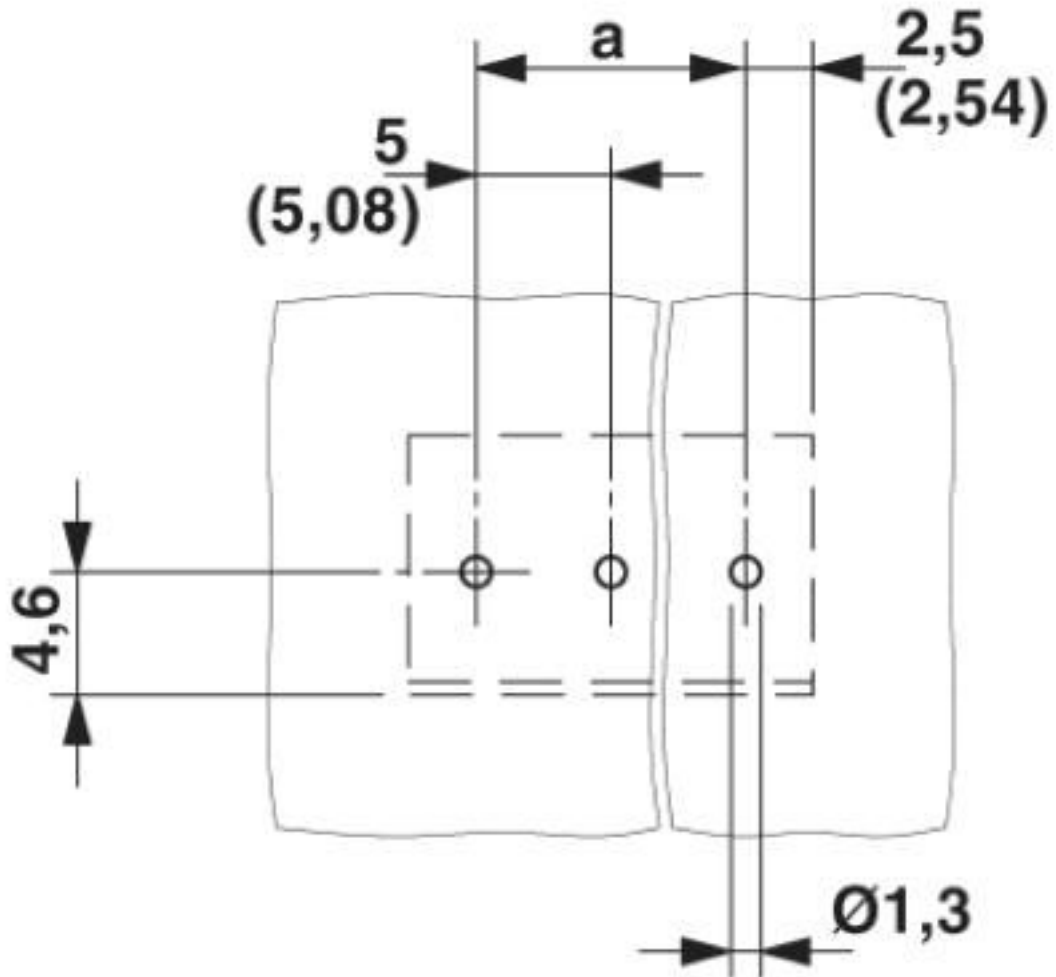

# PCB terminal block - MKDS 1,5/ 7 - 1718948

Dimensional drawing

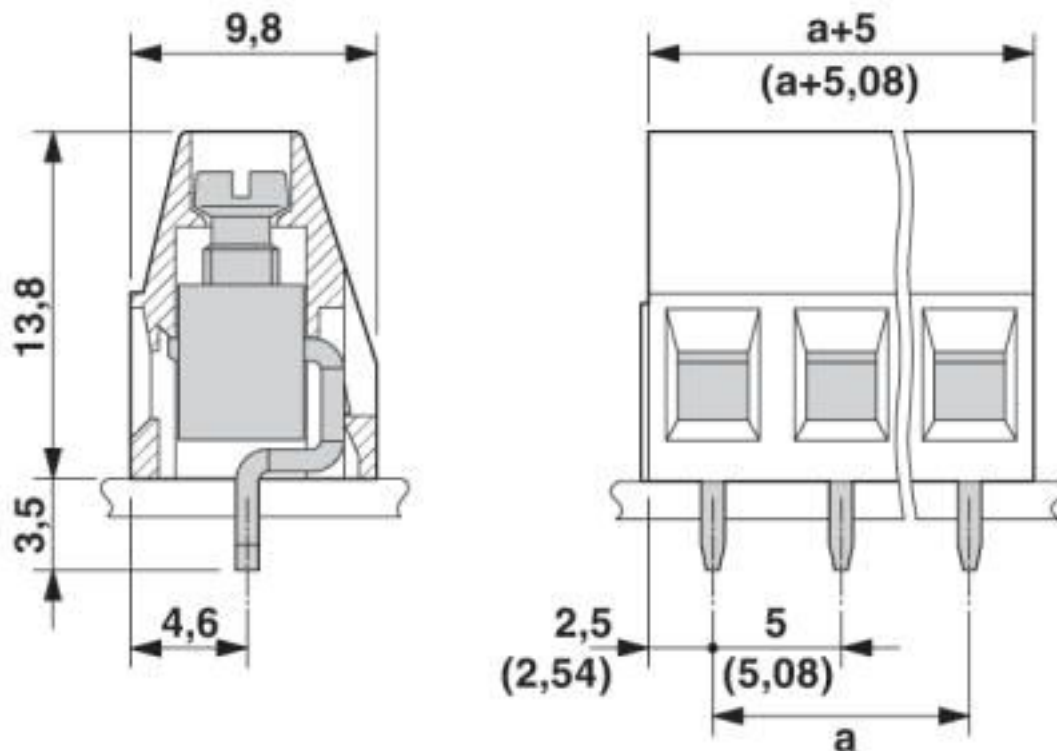

## Classifications

### eCl@ss

eCl@ss 10.0.1	27440401
eCl@ss 4.0	27141100
eCl@ss 4.1	27141100
eCl@ss 5.0	27141100
eCl@ss 5.1	27261100
eCl@ss 6.0	27261100
eCl@ss 7.0	27440401
eCl@ss 8.0	27440401
eCl@ss 9.0	27440401

### ETIM

ETIM 3.0	EC001121
ETIM 4.0	EC002643
ETIM 5.0	EC002643
ETIM 6.0	EC002643
ETIM 7.0	EC002643

### UNSPSC

UNSPSC 6.01	30211801
-------------	----------

# PCB terminal block - MKDS 1,5/ 7 - 1718948

## Classifications

### UNSPSC

UNSPSC 7.0901	39121432
UNSPSC 11	39121432
UNSPSC 12.01	39121432
UNSPSC 13.2	39121432
UNSPSC 18.0	39121432
UNSPSC 19.0	39121432
UNSPSC 20.0	39121432
UNSPSC 21.0	39121432

## Approvals

### Approvals

#### Approvals

DNV GL / CSA / IECCEB Scheme / SEV / EAC / cULus Recognized

#### Ex Approvals

### Approval details

DNV GL		<a href="https://approvalfinder.dnvgl.com/">https://approvalfinder.dnvgl.com/</a>	TAE00001EV
--------	---	---	------------

CSA		<a href="http://www.csagroup.org/services-industries/product-listing/">http://www.csagroup.org/services-industries/product-listing/</a>	13631
	B	D	
Nominal voltage UN	300 V	300 V	
Nominal current IN	10 A	10 A	
mm <sup>2</sup> /AWG/kcmil	28-14	28-14	

IECEE CB Scheme		<a href="http://www.iecee.org/">http://www.iecee.org/</a>	CH-10787
Nominal voltage UN	250 V		
Nominal current IN	24 A		
mm <sup>2</sup> /AWG/kcmil	2.5		



# PCB terminal block - MKDS 1,5/ 7 - 1718948

## Approvals

SEV		<a href="https://www.eurofins.ch/de/">https://www.eurofins.ch/de/</a>	IK-4497
Nominal voltage UN		250 V	
Nominal current IN		24 A	
mm <sup>2</sup> /AWG/kcmil		2.5	

EAC		B.01687
-----	--	---------

cULus Recognized		<a href="http://database.ul.com/cgi-bin/XYV/template/LISEXT/1FRAME/index.htm">http://database.ul.com/cgi-bin/XYV/template/LISEXT/1FRAME/index.htm</a>	E60425-19770427
	B	D	
Nominal voltage UN	300 V	300 V	
Nominal current IN	15 A	10 A	
mm <sup>2</sup> /AWG/kcmil	30-14	30-14	

## Accessories

### Accessories

#### Bridge

Insertion bridge - EBP 2- 5 - 1733169



Insertion bridge for connectors with 5.0 mm or 5.08 mm pitch

Insertion bridge - EBP 3- 5 - 1733172



Insertion bridge for connectors with 5.0 mm or 5.08 mm pitch

## PCB terminal block - MKDS 1,5/ 7 - 1718948

### Accessories

Insertion bridge - EBP 4- 5 - 1733185



Insertion bridge for connectors with 5.0 mm or 5.08 mm pitch

---

### Labeled terminal marker

Marker card - SK 5/3,8:FORTL.ZAHLEN - 0804183



Marker card, Card, white, labeled, horizontal: consecutive numbers 1 ... 10, 11 ... 20, etc. up to 91 ... (99)100, mounting type: adhesive, for terminal block width: 5 mm, lettering field size: 5 x 3.8 mm

---

### Pitch spacer

Pitch spacer - RZ 1,25-MKDS 1,5 - 1702048



Pitch spacer, for adjusting the pitches between MKDS and GMKDS terminal blocks in mixed rows, 1.25 mm thick

---

### Screwdriver tools

Screwdriver - SZS 0,6X3,5 - 1205053



Actuation tool, for ST terminal blocks, insulated, also suitable for use as a bladed screwdriver, size: 0.6 x 3.5 x 100 mm, 2-component grip, with non-slip grip

## X-ON Electronics

Largest Supplier of Electrical and Electronic Components

*Click to view similar products for [Fixed Terminal Blocks](#) category:*

*Click to view products by [Phoenix Contact](#) manufacturer:*

Other Similar products are found below :

[MBE-1512](#) [MBE-154](#) [MBE-156](#) [MBES-153](#) [MBES-156](#) [MH-2512](#) [MHE-132](#) [MHE-163](#) [MI-254 \(35\)](#) [MI-272](#) [880507](#) [MPT-275](#)  
[15602-04-08-21](#) [BA311TU](#) [BA411SU](#) [MV-152](#) [MV-252-D](#) [MV-253/NCNOC](#) [MV-254-D](#) [MV-255](#) [MV-462](#) [MV-493](#) [MVE-252](#) [MVE-253](#)  
[MVE-273](#) [MVEB-153](#) [1700096](#) [1705142](#) [1712417](#) [1713020](#) [1713088](#) [1745195](#) [1760594](#) [1776118-2](#) [1790852](#) [1-796689-8](#) [1-796692-6](#)  
[1800001](#) [1800114](#) [1995279](#) [20020314-C121B01LF](#) [CB2-12](#) [KP03215000J0G](#) [KP04215000J0G](#) [S451](#) [282802-2](#) [29.007](#) [29.116](#) [30.103](#)  
[30.106](#)