

## Pin strip - PST 1,3/ 2-5,0 R24 - 1720301

Please be informed that the data shown in this PDF Document is generated from our Online Catalog. Please find the complete data in the user's documentation. Our General Terms of Use for Downloads are valid (<http://phoenixcontact.com/download>)



Pin strip, nominal current: 12 A, rated voltage (III/2): 320 V, number of positions: 2, pitch: 5 mm, color: black, contact surface: Tin, mounting: THR soldering. The maximum current depends on the plug used. The lower of the two current values apply for plug and pin strip. The pin strip is made of highly temperature resistant plastic and is thus suitable for the reflow process.

The figure shows an 8-pos. version of the item in tape-on-reel packing

### Your advantages

- Suitable for wave and reflow soldering processes
- Optimum pin geometry for all COMBICON pin strip connectors



### Key Commercial Data

Packing unit	330 pc
Minimum order quantity	330 pc
GTIN	
GTIN	4046356115919

### Technical data

#### Dimensions

Length [ l ]	2.8 mm
Width	9.6 mm
Pitch	5 mm
Dimension a	5 mm
Width [ w ]	9.6 mm
Height [ h ]	13 mm
Height	9.5 mm
Length of the solder pin	3.5 mm
Pin dimensions	ø 1.3 mm
Length	2.8 mm

#### General

# Pin strip - PST 1,3/ 2-5,0 R24 - 1720301

## Technical data

### General

Range of articles	PST 1,3/...-V
Insulating material group	IIIa
Rated surge voltage (III/3)	4 kV
Rated surge voltage (III/2)	4 kV
Rated surge voltage (II/2)	4 kV
Rated voltage (III/3)	250 V
Rated voltage (III/2)	320 V
Rated voltage (II/2)	400 V
Connection in acc. with standard	EN-VDE
Nominal current $I_N$	12 A (depends on the plug used)
Maximum load current	12 A (depends on the plug used)
Insulating material	PA
Flammability rating according to UL 94	V0
Color	black
Number of positions	2

### Standards and Regulations

Connection in acc. with standard	EN-VDE
	CSA
Flammability rating according to UL 94	V0

### Environmental Product Compliance

China RoHS	Environmentally friendly use period: unlimited = EFUP-e
	No hazardous substances above threshold values

## Drawings

Drilling diagram

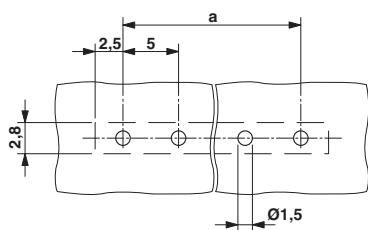

Diagram

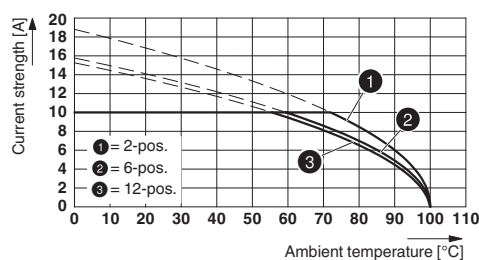

Type: PTS 1,5/...-PH-5,0 with PST 1,3/...-5,0

# Pin strip - PST 1,3/ 2-5,0 R24 - 1720301

Dimensional drawing

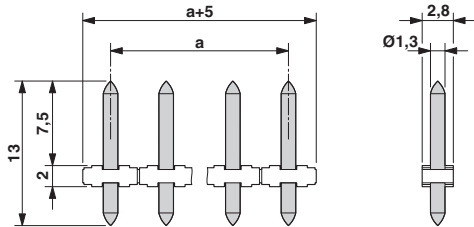

Diagram

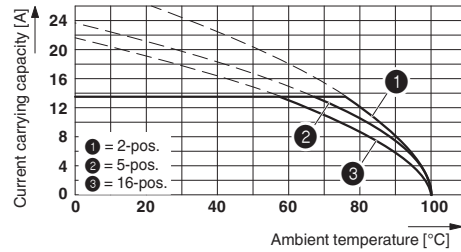

Diagram

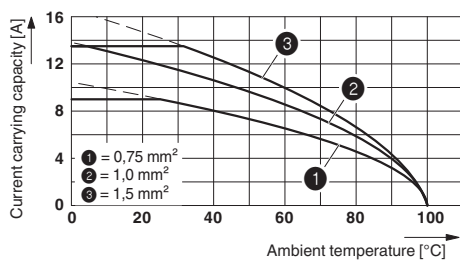

Dimensional drawing

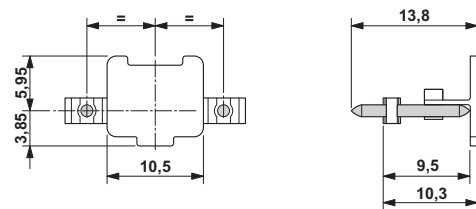

Pad position for PST 1,3/...5,0 R...

Dimensional drawing

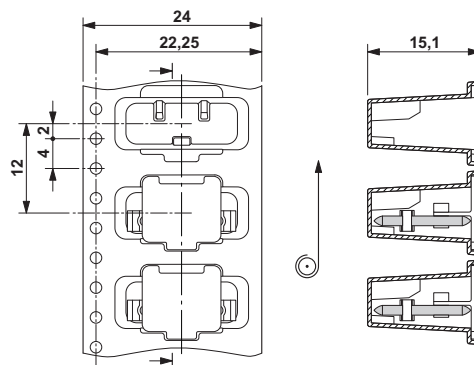

Approvals

Approvals

Approvals

CSA / SEV / EAC / cULus Recognized

# Pin strip - PST 1,3/ 2-5,0 R24 - 1720301

## Approvals

Ex Approvals

### Approval details

CSA		<a href="http://www.csagroup.org/services-industries/product-listing/">http://www.csagroup.org/services-industries/product-listing/</a>	13631
	D	B	
Nominal voltage UN	300 V	300 V	
Nominal current IN	5 A	5 A	

SEV		<a href="https://www.electrosuisse.ch/de/meta/shop/produktezertifikate.html">https://www.electrosuisse.ch/de/meta/shop/produktezertifikate.html</a>	IK-3558-M2
Nominal voltage UN	250 V		
Nominal current IN	10 A		

EAC			B.01742
-----	---	--	---------

cULus Recognized		<a href="http://database.ul.com/cgi-bin/XYV/template/LISEXT/1FRAME/index.htm">http://database.ul.com/cgi-bin/XYV/template/LISEXT/1FRAME/index.htm</a>	E60425-20030211
	D	B	
Nominal voltage UN	300 V	300 V	
Nominal current IN	10 A	16 A	

Phoenix Contact 2018 © - all rights reserved  
<http://www.phoenixcontact.com>

PHOENIX CONTACT GmbH & Co. KG  
 Flachsmarktstr. 8  
 32825 Blomberg  
 Germany  
 Tel. +49 5235 300  
 Fax +49 5235 3 41200  
<http://www.phoenixcontact.com>

## X-ON Electronics

Largest Supplier of Electrical and Electronic Components

*Click to view similar products for [Headers & Wire Housings](#) category:*

*Click to view products by [Phoenix Contact](#) manufacturer:*

Other Similar products are found below :

[892-18-020-10-001101](#) [58102-G61-06LF](#) [582553-1](#) [0009485154](#) [009176003701906](#) [0050291907](#) [LY20-4P-DT1-P1E-BR](#) [02.125.8002.8](#)  
[609-3404](#) [61062-3](#) [61082-181009](#) [622-3653LF](#) [63453-116](#) [636-1030](#) [636-1427](#) [636-3427](#) [636-4007](#) [641938-9](#) [641991-4](#) [644827-2](#) [65817-](#)  
[010LF](#) [65817-015LF](#) [65863-015LF](#) [66207-023LF](#) [67095-007LF](#) [67601157](#) [68648-049](#) [70.362.1628.0](#) [70-4210](#) [70-4226B](#) [70-4853B](#) [707-](#)  
[5020](#) [707-5028](#) [71.350.2428.0](#) [71918-208LF](#) [71961-016LF](#) [733-134](#) [733-162](#) [754199-000](#) [760-3052](#) [787-8014-00](#) [79531-3000](#) [FCN-](#)  
[360C032-B](#) [FCN-367T-T012/H](#) [FCN-723D010/2](#) [80.063.4001.1](#) [800-90-001-10-001000](#) [800-90-010-10-002000](#) [801-43-002-10-013000](#)  
[801-43-006-10-002000](#)