

PCB terminal block - MKDS 1/ 9-3,81 SMD BK - 1727298

Please be informed that the data shown in this PDF Document is generated from our Online Catalog. Please find the complete data in the user's documentation. Our General Terms of Use for Downloads are valid (<http://phoenixcontact.com/download>)

PCB terminal block, nominal current: 8 A, rated voltage (III/2): 160 V, nominal cross section: 1 mm², pitch: 3.81 mm, number of positions: 9, connection method: Screw connection with tension sleeve, mounting: SMD soldering, conductor/PCB connection direction: 0 °, color: black, Pin layout: Linear pad geometry



The figure shows a 10-position version of the product

Your advantages

- Well-known connection principle allows worldwide use
- Low temperature rise, thanks to maximum contact force
- Allows connection of two conductors
- Extremely small design for the respective conductor cross section
- Designed for integration into the SMT soldering process



Key Commercial Data

Packing unit	12 pc
Minimum order quantity	12 pc
GTIN	
GTIN	4017918025663

Technical data

Item properties

Brief article description	PCB terminal block
Range of articles	MKDS 1/..-SMD
Pitch	3.81 mm
Number of positions	9
Connection method	Screw connection with tension sleeve
Screw thread	M2
Mounting type	SMD soldering
Pin layout	Linear pad geometry
Number of levels	1

PCB terminal block - MKDS 1/ 9-3,81 SMD BK - 1727298

Technical data

Item properties

Number of connections	9
Number of potentials	9

Electrical parameters

Nominal current	8 A
Nom. voltage	160 V
Rated voltage	160 V
Rated voltage (III/2)	160 V
Rated voltage (II/2)	250 V
Rated surge voltage (III/3)	2.5 kV
Rated surge voltage (III/2)	2.5 kV
Rated surge voltage (II/2)	2.5 kV

Connection capacity

Connection method	Screw connection with tension sleeve
pluggable	no
Conductor cross section solid	0.14 mm ² ... 1.5 mm ²
Conductor cross section flexible	0.14 mm ² ... 1 mm ²
Conductor cross section AWG / kcmil	26 ... 16
Conductor cross section flexible, with ferrule without plastic sleeve	0.25 mm ² ... 0.5 mm ²
Conductor cross section, flexible, with ferrule, with plastic sleeve	0.25 mm ² ... 0.5 mm ²
2 conductors with same cross section, solid	0.14 mm ² ... 0.5 mm ²
2 conductors with same cross section, flexible	0.14 mm ² ... 0.2 mm ²
Stripping length	5 mm
Torque	0.22 Nm ... 0.25 Nm

Material data - contact

Note	WEEE/RoHS-compliant, free of whiskers according to IEC 60068-2-82/ JEDEC JESD 201
Contact material	Cu alloy
Surface characteristics	Tin-plated
Metal surface terminal point (top layer)	Tin (5 - 7 µm Sn)
Metal surface terminal point (middle layer)	Nickel (2 - 3 µm Ni)
Metal surface soldering area (top layer)	Tin (5 - 7 µm Sn)
Metal surface soldering area (middle layer)	Nickel (2 - 3 µm Ni)

Material data - housing

Housing color	black (9005)
Insulating material	PA
Insulating material group	IIIa
CTI according to IEC 60112	325
Flammability rating according to UL 94	V0
Glow wire flammability index GWFI according to EN 60695-2-12	850

PCB terminal block - MKDS 1/ 9-3,81 SMD BK - 1727298

Technical data

Material data - housing

Glow wire ignition temperature GWIT according to EN 60695-2-13	775
Temperature for the ball pressure test according to EN 60695-10-2	125 °C

Dimensions for the product

Caption	Schematic representation – for additional information, see product range drawing in the Download Center
Length [l]	7.3 mm
Width [w]	34.28 mm
Height [h]	9.2 mm
Pitch	3.81 mm
Height (without solder pin)	9.2 mm

Packaging information

Type of packaging	Tube magazine
Pieces per package	12
Denomination packing units	Pcs.

General product information

Type of note	Note on application
Note	Pick and place pads may protrude beyond the components. The PCB layout must ensure that collisions are avoided when components are assembled.

Ambient conditions

Ambient temperature (storage/transport)	-40 °C ... 70 °C
Ambient temperature (assembly)	-5 °C ... 100 °C
Ambient temperature (operation)	-40 °C ... 100 °C (dependent on the derating curve)

Electrical tests

Rated current	8 A
Conductor cross section	1 mm ²
Rated voltage (III/2)	160 V
Rated surge voltage (III/2)	2.5 kV

Standards and Regulations

Connection in acc. with standard	EN-VDE
	CSA
Flammability rating according to UL 94	V0

Environmental Product Compliance

REACH SVHC	Lead 7439-92-1
China RoHS	Environmentally Friendly Use Period = 50 years
	For details about hazardous substances go to tab "Downloads", Category "Manufacturer's declaration"

Drawings

PCB terminal block - MKDS 1/ 9-3,81 SMD BK - 1727298

Drilling diagram

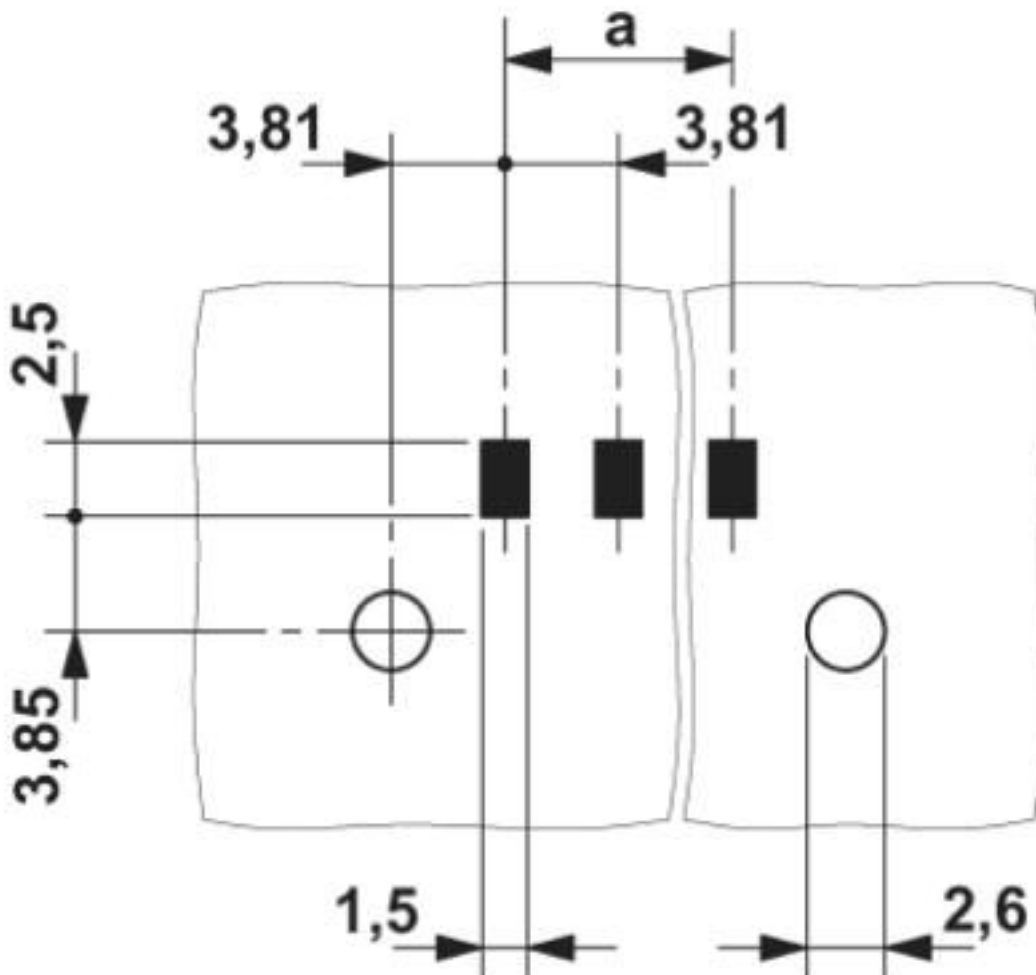

Dimensional drawing

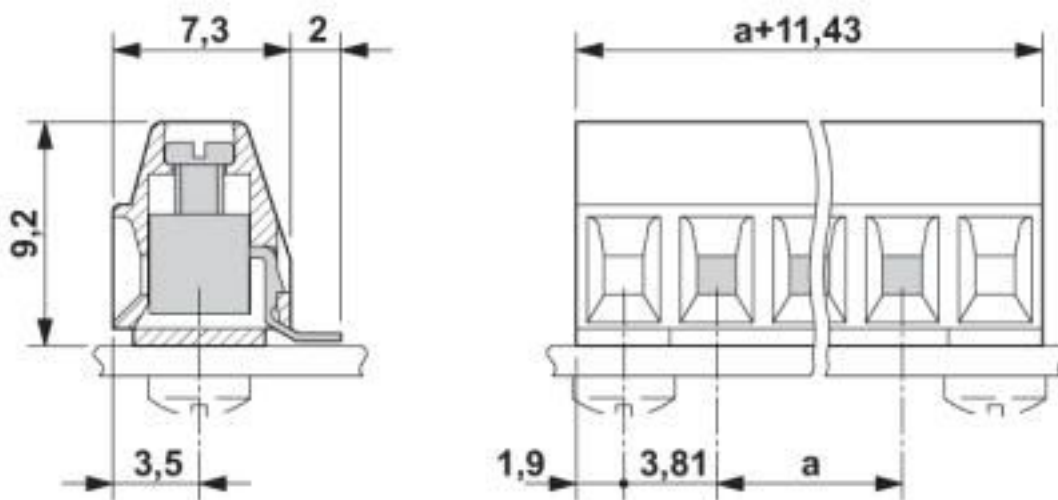

PCB terminal block - MKDS 1/ 9-3,81 SMD BK - 1727298

Classifications

eCl@ss

eCl@ss 10.0.1	27440401
eCl@ss 4.0	27141100
eCl@ss 4.1	27141100
eCl@ss 5.0	27141100
eCl@ss 5.1	27261100
eCl@ss 6.0	27261100
eCl@ss 7.0	27440401
eCl@ss 8.0	27440401
eCl@ss 9.0	27440401

ETIM

ETIM 3.0	EC001121
ETIM 4.0	EC002643
ETIM 5.0	EC002643
ETIM 6.0	EC002643
ETIM 7.0	EC002643

UNSPSC

UNSPSC 6.01	30211801
UNSPSC 7.0901	39121432
UNSPSC 11	39121432
UNSPSC 12.01	39121432
UNSPSC 13.2	39121432
UNSPSC 18.0	39121432
UNSPSC 19.0	39121432
UNSPSC 20.0	39121432
UNSPSC 21.0	39121432

Approvals

Approvals

Approvals

IECEE CB Scheme / SEV / EAC / cULus Recognized

Ex Approvals

Approval details

PCB terminal block - MKDS 1/ 9-3,81 SMD BK - 1727298

Approvals

IECEE CB Scheme		http://www.iecee.org/	CH-10787
Nominal voltage UN	160 V		
Nominal current IN	12 A		
mm ² /AWG/kcmil	1.5		

SEV		https://www.eurofins.ch/de/	IK-4497
Nominal voltage UN	160 V		
Nominal current IN	12 A		
mm ² /AWG/kcmil	1.5		

EAC			B.01687
-----	--	--	---------

cULus Recognized		http://database.ul.com/cgi-bin/XYV/template/LISEXT/1FRAME/index.htm	E60425-19770427
	B	D	
Nominal voltage UN	300 V	300 V	
Nominal current IN	10 A	10 A	
mm ² /AWG/kcmil	30-16	30-16	

Accessories

Accessories

Labeled terminal marker

Marker card - SK 3,81/2,8:FORTL.ZAHLEN - 0804109



Marker card, Card, white, labeled, horizontal: consecutive numbers 1 ... 10, 11 ... 20, etc. up to 91 ... (99)100, mounting type: adhesive, for terminal block width: 3.81 mm, lettering field size: 3.81 x 2.8 mm

Screwdriver tools

PCB terminal block - MKDS 1/ 9-3,81 SMD BK - 1727298

Accessories

Screwdriver - SZS 0,4X2,5 VDE - 1205037



Screwdriver, slot-headed, VDE insulated, size: 0.4 x 2.5 x 80 mm, 2-component grip, with non-slip grip

Phoenix Contact 2020 © - all rights reserved
<http://www.phoenixcontact.com>

PHOENIX CONTACT GmbH & Co. KG
Flachsmarktstr. 8
32825 Blomberg
Germany
Tel. +49 5235 300
Fax +49 5235 3 41200
<http://www.phoenixcontact.com>

X-ON Electronics

Largest Supplier of Electrical and Electronic Components

Click to view similar products for [Fixed Terminal Blocks](#) category:

Click to view products by [Phoenix Contact](#) manufacturer:

Other Similar products are found below :

[MBE-1512](#) [MBE-154](#) [MBE-156](#) [MBES-153](#) [MBES-156](#) [MH-2512](#) [MHE-132](#) [MHE-163](#) [MI-254 \(35\)](#) [MI-272](#) [880507](#) [MPT-275](#)
[15602-04-08-21](#) [BA311TU](#) [BA411SU](#) [MV-152](#) [MV-252-D](#) [MV-253/NCNOC](#) [MV-254-D](#) [MV-255](#) [MV-462](#) [MV-493](#) [MVE-252](#) [MVE-253](#)
[MVE-273](#) [MVEB-153](#) [1700096](#) [1705142](#) [1712417](#) [1713020](#) [1713088](#) [1745195](#) [1760594](#) [1776118-2](#) [1790852](#) [1-796689-8](#) [1-796692-6](#)
[1800001](#) [1800114](#) [1995279](#) [20020314-C121B01LF](#) [CB2-12](#) [KP03215000J0G](#) [KP04215000J0G](#) [S451](#) [282802-2](#) [29.007](#) [29.116](#) [30.103](#)
[30.106](#)