

# Printed-circuit board connector - GIC 2,5 HC/12-G-7,62 - 1745881

Please be informed that the data shown in this PDF Document is generated from our Online Catalog. Please find the complete data in the user's documentation. Our General Terms of Use for Downloads are valid (<http://phoenixcontact.com/download>)

PCB headers, nominal current: 16 A, rated voltage (III/2): 630 V, nominal cross section: 2.5 mm<sup>2</sup>, number of positions: 12, pitch: 7.62 mm, color: green, contact surface: Tin, mounting: Wave soldering, pin layout: Linear pinning, solder pin [P]: 3.5 mm



The figure shows the 5-pos. version

## Your advantages

- Well-known mounting principle allows worldwide use
- Inverted header with socket contacts for touch-proof device outputs or PCB/PCB connections
- Integrated double steel spring provides additional safety in the event of temperature and power fluctuations



## Key Commercial Data

Packing unit	50 pc
GTIN	 4 046356 310376
GTIN	4046356310376

## Technical data

### Dimensions

Length [ l ]	19 mm
Width	91.44 mm
Pitch	7.62 mm
Dimension a	83.82 mm
Width [ w ]	91.44 mm
Height [ h ]	13.7 mm
Installed height	10.2 mm
Length of the solder pin	3.5 mm
Pin dimensions	0.47 x 1.14 mm
Pin spacing	5.04 mm
Length	19 mm

### General

# Printed-circuit board connector - GIC 2,5 HC/12-G-7,62 - 1745881

## Technical data

### General

Range of articles	GIC 2,5 HC/..-G
Insulating material group	I
Rated surge voltage (III/3)	6 kV
Rated surge voltage (III/2)	6 kV
Rated surge voltage (II/2)	6 kV
Rated voltage (III/3)	630 V
Rated voltage (III/2)	630 V
Rated voltage (II/2)	1000 V
Connection in acc. with standard	EN-VDE
Nominal current I <sub>N</sub>	16 A
Insulating material	PA
Flammability rating according to UL 94	V0
Color	green
Number of positions	12

### Standards and Regulations

Connection in acc. with standard	EN-VDE
	CUL
Flammability rating according to UL 94	V0

### Environmental Product Compliance

China RoHS	Environmentally friendly use period: unlimited = EFUP-e
	No hazardous substances above threshold values

## Drawings

# Printed-circuit board connector - GIC 2,5 HC/12-G-7,62 - 1745881

Drilling diagram

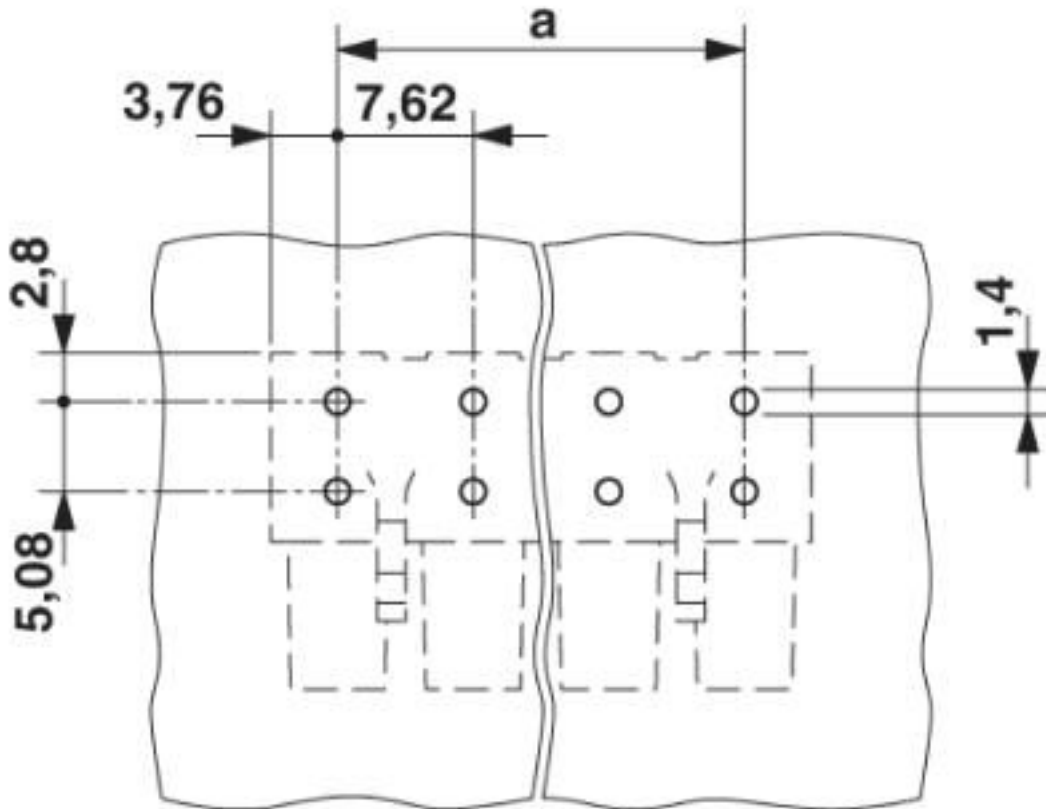

Diagram

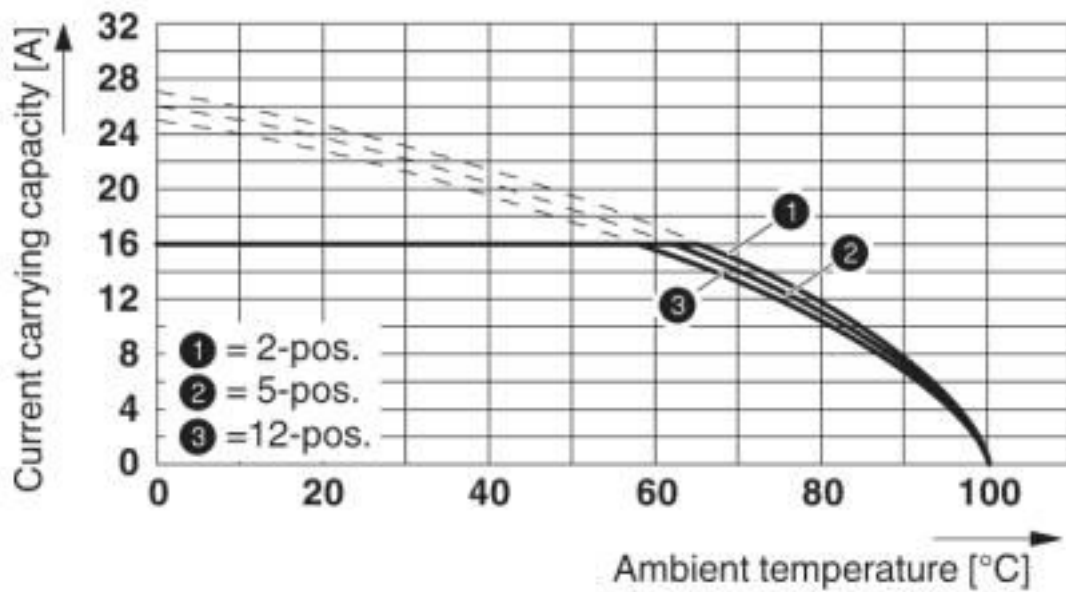

Derating curve for: GIC 2,5 HC/...-ST-7,62 with GIC 2,5 HC/...-G-7,62

# Printed-circuit board connector - GIC 2,5 HC/12-G-7,62 - 1745881

Dimensional drawing

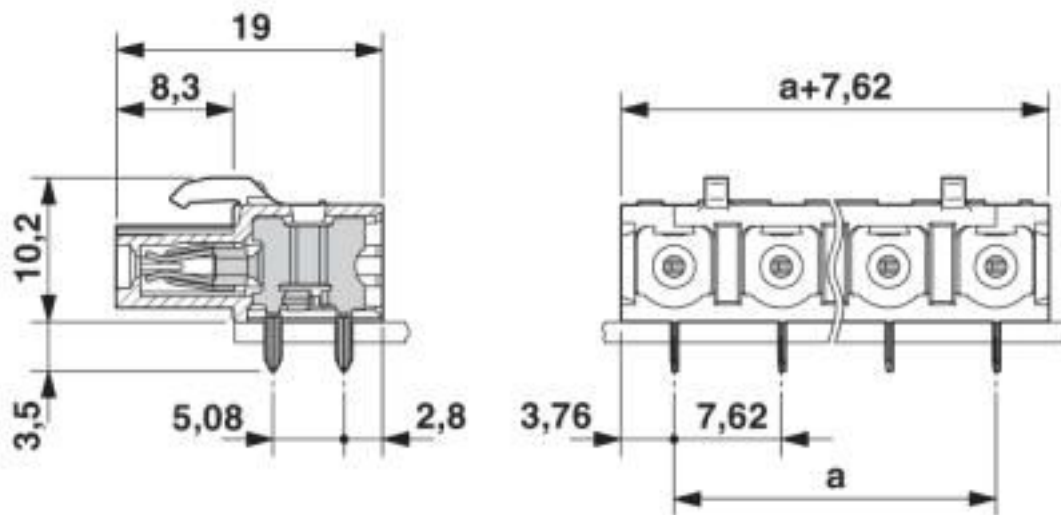

## Classifications

### eCl@ss

eCl@ss 10.0.1	27440402
eCl@ss 4.0	27260700
eCl@ss 4.1	27260700
eCl@ss 5.0	27260700
eCl@ss 5.1	27260700
eCl@ss 6.0	27260700
eCl@ss 7.0	27440402
eCl@ss 8.0	27440402
eCl@ss 9.0	27440402

### ETIM

ETIM 3.0	EC001121
ETIM 4.0	EC002637
ETIM 5.0	EC002637
ETIM 6.0	EC002637
ETIM 7.0	EC002637

### UNSPSC

UNSPSC 6.01	30211801
UNSPSC 7.0901	39121432
UNSPSC 11	39121432
UNSPSC 12.01	39121432
UNSPSC 13.2	39121409
UNSPSC 18.0	39121409
UNSPSC 19.0	39121409

# Printed-circuit board connector - GIC 2,5 HC/12-G-7,62 - 1745881

## Classifications

### UNSPSC

UNSPSC 20.0	39121409
UNSPSC 21.0	39121409

## Approvals

### Approvals

#### Approvals

EAC / cULus Recognized / IECEE CB Scheme / VDE Zeichengenehmigung

#### Ex Approvals

### Approval details

EAC		B.01687
-----	---	---------

cULus Recognized		<a href="http://database.ul.com/cgi-bin/XYV/template/LISEXT/1FRAME/index.htm">http://database.ul.com/cgi-bin/XYV/template/LISEXT/1FRAME/index.htm</a>	E60425-19931014
	B	D	
Nominal voltage UN	250 V	300 V	
Nominal current IN	16 A	10 A	

IECEE CB Scheme		<a href="http://www.iecee.org/">http://www.iecee.org/</a>	DE1-60988-B1B2
Nominal voltage UN	400 V		
Nominal current IN	16 A		

VDE Zeichengenehmigung		<a href="http://www2.vde.com/de/Institut/Online-Service/VDE-gepruefteProdukte/Seiten/Online-Suche.aspx">http://www2.vde.com/de/Institut/Online-Service/VDE-gepruefteProdukte/Seiten/Online-Suche.aspx</a>	40050079
Nominal voltage UN	400 V		
Nominal current IN	16 A		

## Printed-circuit board connector - GIC 2,5 HC/12-G-7,62 - 1745881

### Accessories

#### Additional products

Plug - GIC 2,5 HCV/12-ST-7,62 - 1745726



PCB connector, nominal current: 16 A, rated voltage (III/2): 1000 V, nominal cross section: 2.5 mm<sup>2</sup>, number of positions: 12, pitch: 7.62 mm, connection method: Screw connection with tension sleeve, color: green, contact surface: Tin

Feed-through header - GMSTBA 2,5 HC/12-G-7,62 - 1728950



PCB headers, nominal current: 16 A, rated voltage (III/2): 630 V, nominal cross section: 2.5 mm<sup>2</sup>, number of positions: 12, pitch: 7.62 mm, color: green, contact surface: Tin, mounting: Wave soldering, pin layout: Linear pinning, solder pin [P]: 3.2 mm

Printed-circuit board connector - GMSTBVA 2,5 HC/12-G-7,62 - 1792452



PCB headers, nominal current: 16 A, rated voltage (III/2): 630 V, nominal cross section: 2.5 mm<sup>2</sup>, number of positions: 12, pitch: 7.62 mm, color: green, contact surface: Tin, mounting: Wave soldering, pin layout: Linear pinning, solder pin [P]: 3.9 mm

Phoenix Contact 2020 © - all rights reserved  
<http://www.phoenixcontact.com>

PHOENIX CONTACT GmbH & Co. KG  
Flachsmarktstr. 8  
32825 Blomberg  
Germany  
Tel. +49 5235 300  
Fax +49 5235 3 41200  
<http://www.phoenixcontact.com>

## X-ON Electronics

Largest Supplier of Electrical and Electronic Components

*Click to view similar products for [Pluggable Terminal Blocks](#) category:*

*Click to view products by [Phoenix Contact](#) manufacturer:*

Other Similar products are found below :

[57.510.0053](#) [MC 1.5/ 6-ST-3.5 GY AU](#) [734-104](#) [734-302](#) [8-141-P](#) [8426620000](#) [860505](#) [860810](#) [GBPACX-12](#) [93.731.4953.0](#) [PV05-5,08-K](#)  
[PVP02-5,00](#) [PVP03-3,50](#) [PVP04-3,50](#) [PVS02-5,00](#) [1-1986160-3](#) [1377680000](#) [1531000000](#) [1546228-5](#) [ELFH16150](#) [ELFP03110](#)  
[ELFP10210](#) [ELFT06250](#) [ELVP03100](#) [1700101](#) [1700410](#) [1700425](#) [1702246](#) [1705229](#) [1710175](#) [1714537](#) [1717806](#) [1719600](#) [1728941](#)  
[1734692](#) [1734795](#) [1736036](#) [1740194](#) [1740291](#) [1740628](#) [1740990](#) [1746952](#) [1750207](#) [1752441](#) [1752865](#) [1754115](#) [1754144](#) [1756913](#)  
[1760051](#) [1760336](#)