

PCB terminal block - ZFKDSA 1-W-3,81- 7 - 1747931

Please be informed that the data shown in this PDF Document is generated from our Online Catalog. Please find the complete data in the user's documentation. Our General Terms of Use for Downloads are valid (<http://phoenixcontact.com/download>)



PCB terminal block, nominal current: 12 A, rated voltage (III/2): 200 V, nominal cross section: 1 mm², pitch: 3.81 mm, number of positions: 7, connection method: Spring-cage connection, mounting: Wave soldering, conductor/PCB connection direction: 45 °, color: green, Pin layout: Linear double pinning, Solder pin [P]: 3.5 mm

The figure shows the 10-position version

Your advantages

- Defined contact force ensures that contact remains stable over the long term
- Can be operated without tools by means of color-coded actuating lever
- Angled connection enables multi-row arrangement on the PCB
- The latching on the side enables various numbers of positions to be combined
- Two solder pins reduce the mechanical strain on the soldering spots



Key Commercial Data

Packing unit	50 pc
GTIN	
GTIN	4046356299916

Technical data

Item properties

Brief article description	PCB terminal block
Range of articles	ZFKDS(A) 1-W
Pitch	3.81 mm
Number of positions	7
Connection method	Spring-cage connection
Mounting type	Wave soldering
Pin layout	Linear double pinning
Number of levels	1
Number of connections	7
Number of potentials	7

PCB terminal block - ZFKDSA 1-W-3,81- 7 - 1747931

Technical data

Electrical parameters

Nominal current	12 A
Nom. voltage	200 V
Rated voltage	160 V
Rated voltage (III/2)	200 V
Rated voltage (II/2)	400 V
Rated surge voltage (III/3)	2.5 kV
Rated surge voltage (III/2)	2.5 kV
Rated surge voltage (II/2)	2.5 kV

Connection capacity

Connection method	Spring-cage connection
pluggable	Yes
Conductor cross section solid	0.14 mm ² ... 1.5 mm ²
Conductor cross section flexible	0.14 mm ² ... 1 mm ²
Conductor cross section AWG / kcmil	26 ... 16
Conductor cross section flexible, with ferrule without plastic sleeve	0.25 mm ² ... 0.5 mm ²
Conductor cross section, flexible, with ferrule, with plastic sleeve	0.25 mm ² ... 0.5 mm ²
Stripping length	7.5 mm

Material data - contact

Note	WEEE/RoHS-compliant, free of whiskers according to IEC 60068-2-82/ JEDEC JESD 201
Contact material	Cu alloy
Surface characteristics	hot-dip tin-plated
Metal surface terminal point (top layer)	Tin (10 - 16 µm Sn)
Metal surface soldering area (top layer)	Tin (10 - 16 µm Sn)

Material data - housing

Housing color	green (6021)
Insulating material	PA
Insulating material group	I
CTI according to IEC 60112	600
Flammability rating according to UL 94	V0
Glow wire flammability index GWFI according to EN 60695-2-12	850
Glow wire ignition temperature GWIT according to EN 60695-2-13	775
Temperature for the ball pressure test according to EN 60695-10-2	125 °C

Dimensions for the product

Length [l]	17.46 mm
Width [w]	29.71 mm
Height [h]	19.48 mm
Pitch	3.81 mm
Height (without solder pin)	15.98 mm

PCB terminal block - ZFKDSA 1-W-3,81- 7 - 1747931

Technical data

Dimensions for the product

Solder pin [P]	3.5 mm
Pin dimensions	0.7 x 1 mm

Dimensions for PCB design

Hole diameter	1.2 mm
---------------	--------

Packaging information

Type of packaging	packed in cardboard
Pieces per package	50
Denomination packing units	Pcs.

Electrical tests

Rated current	12 A
Conductor cross section	1 mm ²
Rated voltage (III/2)	200 V
Rated surge voltage (III/2)	2.5 kV

Air clearances and creepage distances

Clearances and creepage distances	IEC 60664-1:2007-04
Specification	IEC 60664-1:2007-04
Minimum clearance - inhomogeneous field (III/3)	8 mm
Minimum clearance - inhomogeneous field (III/2)	8 mm
Minimum clearance - inhomogeneous field (II/2)	5.5 mm
Minimum creepage distance value (III/3)	8 mm
Minimum creepage distance value (III/2)	5 mm
Minimum creepage distance value (II/2)	5 mm

Standards and Regulations

Connection in acc. with standard	EN-VDE
	CUL

Environmental Product Compliance

China RoHS	Environmentally friendly use period: unlimited = EFUP-e
	No hazardous substances above threshold values

Drawings

PCB terminal block - ZFKDSA 1-W-3,81- 7 - 1747931

Drilling diagram

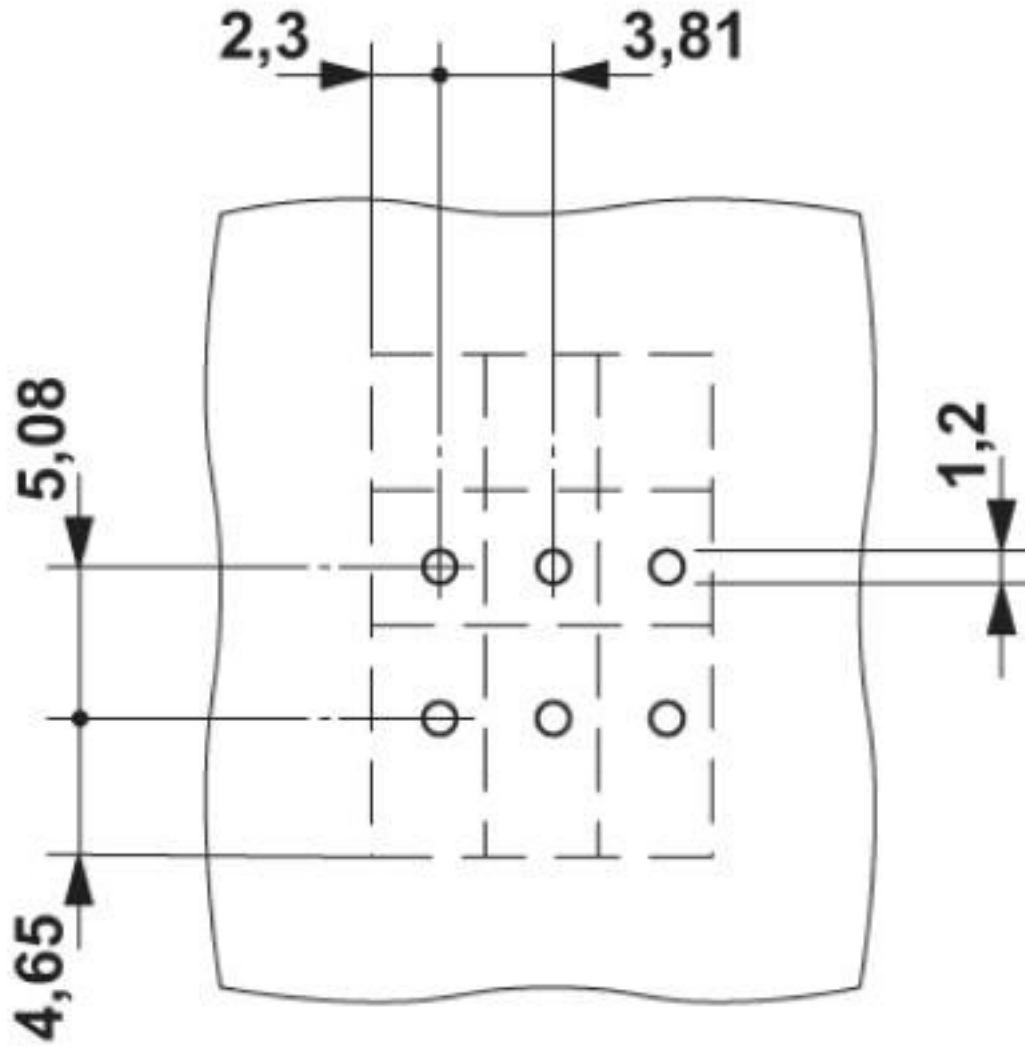

PCB terminal block - ZFKDSA 1-W-3,81- 7 - 1747931

Dimensional drawing

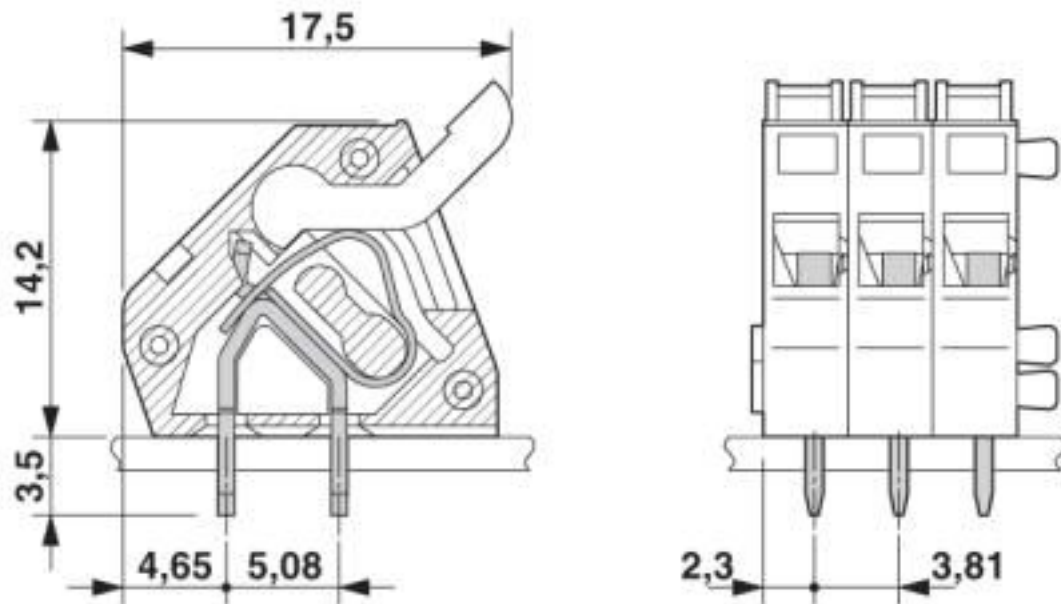

Classifications

eCl@ss

eCl@ss 10.0.1	27440401
eCl@ss 4.0	27141100
eCl@ss 4.1	27141100
eCl@ss 5.0	27141100
eCl@ss 5.1	27261100
eCl@ss 6.0	27261100
eCl@ss 7.0	27440401
eCl@ss 8.0	27440401
eCl@ss 9.0	27440401

ETIM

ETIM 3.0	EC001121
ETIM 4.0	EC002643
ETIM 5.0	EC002643
ETIM 6.0	EC002643
ETIM 7.0	EC002643

UNSPSC

UNSPSC 6.01	30211801
UNSPSC 7.0901	39121432
UNSPSC 11	39121432
UNSPSC 12.01	39121432
UNSPSC 13.2	39121432

PCB terminal block - ZFKDSA 1-W-3,81- 7 - 1747931

Classifications

UNSPSC

UNSPSC 18.0	39121432
UNSPSC 19.0	39121432
UNSPSC 20.0	39121432
UNSPSC 21.0	39121432

Approvals

Approvals

Approvals

EAC / cULus Recognized

Ex Approvals

Approval details

EAC		B.01687
-----	--	---------

cULus Recognized		http://database.ul.com/cgi-bin/XYV/template/LISEXT/1FRAME/index.htm	E60425-19941110
	B	D	
Nominal voltage UN	250 V	300 V	
Nominal current IN	10 A	10 A	
mm ² /AWG/kcmil	26-12	26-12	

Phoenix Contact 2020 © - all rights reserved
<http://www.phoenixcontact.com>

PHOENIX CONTACT GmbH & Co. KG
Flachsmarktstr. 8
32825 Blomberg
Germany
Tel. +49 5235 300
Fax +49 5235 3 41200
<http://www.phoenixcontact.com>

X-ON Electronics

Largest Supplier of Electrical and Electronic Components

Click to view similar products for [Fixed Terminal Blocks](#) category:

Click to view products by [Phoenix Contact](#) manufacturer:

Other Similar products are found below :

[MBE-1512](#) [MBE-154](#) [MBE-156](#) [MBES-153](#) [MBES-156](#) [MH-2512](#) [MHE-132](#) [MHE-163](#) [MI-254 \(35\)](#) [MI-272](#) [880507](#) [MPT-275](#)
[15602-04-08-21](#) [BA311TU](#) [BA411SU](#) [MV-152](#) [MV-252-D](#) [MV-253/NCNOC](#) [MV-254-D](#) [MV-255](#) [MV-462](#) [MV-493](#) [MVE-252](#) [MVE-253](#)
[MVE-273](#) [MVEB-153](#) [1700096](#) [1705142](#) [1712417](#) [1713020](#) [1713088](#) [1745195](#) [1760594](#) [1776118-2](#) [1790852](#) [1-796689-8](#) [1-796692-6](#)
[1800001](#) [1800114](#) [1995279](#) [20020314-C121B01LF](#) [CB2-12](#) [KP03215000J0G](#) [KP04215000J0G](#) [S451](#) [282802-2](#) [29.007](#) [29.116](#) [30.103](#)
[30.106](#)