

Printed-circuit board connector - ISPC 16/ 7-STF-10,16 - 1748671

Please be informed that the data shown in this PDF Document is generated from our Online Catalog. Please find the complete data in the user's documentation. Our General Terms of Use for Downloads are valid (<http://phoenixcontact.com/download>)

PCB connector, nominal current: 76 A, rated voltage (III/2): 1000 V, nominal cross section: 16 mm², number of positions: 7, pitch: 10.16 mm, connection method: Push-in spring connection, color: green, contact surface: Silver



The figure shows the 5-pos. version

Your advantages

- Time saving push-in connection, tools not required
- Defined contact force ensures that contact remains stable over the long term
- Clamping space opened by means of fixed screwdriver enables convenient conductor connection
- Inverted connector with pin contacts for touch-proof device outputs or free-hanging cable/cable connections
- Screwable flange for superior mechanical stability

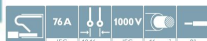

Key Commercial Data

Packing unit	50 pc
GTIN	 4 046356 310734
GTIN	4046356310734

Technical data

Item properties

Brief article description	Printed-circuit board connector
Plug-in system	POWER COMBICON 16
Type of contact	Male connector
Range of articles	ISPC 16/..-STF
Pitch	10.16 mm
Number of positions	7
Connection method	Push-in spring connection
Locking	Screw flange
Number of levels	1
Number of connections	7
Number of potentials	7

Printed-circuit board connector - ISPC 16/ 7-STF-10,16 - 1748671

Technical data

Electrical parameters

Nominal current	76 A
Nom. voltage	1000 V
Rated voltage	1000 V
Rated voltage (III/2)	1000 V
Rated voltage (II/2)	1000 V
Rated surge voltage (III/3)	8 kV
Rated surge voltage (III/2)	8 kV
Rated surge voltage (II/2)	6 kV

Connection capacity

Connection method	Push-in spring connection
pluggable	Yes
Conductor cross section solid	0.75 mm ² ... 16 mm ²
Conductor cross section flexible	0.75 mm ² ... 16 mm ²
Conductor cross section AWG / kcmil	18 ... 4
Conductor cross section flexible, with ferrule without plastic sleeve	0.75 mm ² ... 16 mm ²
Conductor cross section, flexible, with ferrule, with plastic sleeve	0.75 mm ² ... 10 mm ²
2 conductors with the same cross section, flexible, with TWIN ferrule with plastic sleeve	0.75 mm ² ... 4 mm ²
Stripping length	18 mm

Material data - contact

Note	WEEE/RoHS-compliant, free of whiskers according to IEC 60068-2-82/ JEDEC JESD 201
Contact material	Cu alloy
Metal surface terminal point (top layer)	Silver (4 - 8 µm Ag)
Metal surface contact area (top layer)	Silver (4 - 8 µm Ag)

Material data - housing

Housing color	green (6021)
Insulating material	PA
Insulating material group	I
CTI according to IEC 60112	600
Flammability rating according to UL 94	V0
Glow wire flammability index GWFI according to EN 60695-2-12	850
Glow wire ignition temperature GWIT according to EN 60695-2-13	775
Temperature for the ball pressure test according to EN 60695-10-2	125 °C

Dimensions for the product

Length [l]	45.1 mm
Width [w]	88.88 mm
Height [h]	25.1 mm
Pitch	10.16 mm
Height (without solder pin)	25.1 mm

Printed-circuit board connector - ISPC 16/ 7-STF-10,16 - 1748671

Technical data

Packaging information

Type of packaging	packed in cardboard
Pieces per package	50
Denomination packing units	Pcs.

Environmental Product Compliance

China RoHS	Environmentally friendly use period: unlimited = EFUP-e
	No hazardous substances above threshold values

Drawings

Dimensional drawing

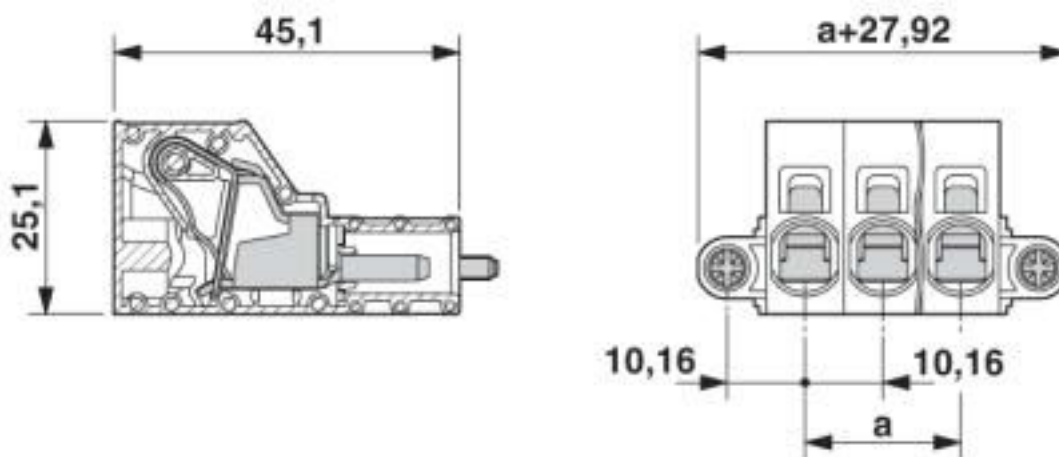

Classifications

eCl@ss

eCl@ss 10.0.1	27440309
eCl@ss 4.0	27260700
eCl@ss 4.1	27260700
eCl@ss 5.0	27260700
eCl@ss 5.1	27260700
eCl@ss 6.0	27260700
eCl@ss 7.0	27440309
eCl@ss 8.0	27440309
eCl@ss 9.0	27440309

ETIM

ETIM 3.0	EC001121
ETIM 4.0	EC002638
ETIM 5.0	EC002638
ETIM 6.0	EC002638

Printed-circuit board connector - ISPC 16/ 7-STF-10,16 - 1748671

Classifications

ETIM

ETIM 7.0	EC002638
----------	----------

UNSPSC

UNSPSC 6.01	30211810
UNSPSC 7.0901	39121409
UNSPSC 11	39121409
UNSPSC 12.01	39121409
UNSPSC 13.2	39121409
UNSPSC 18.0	39121409
UNSPSC 19.0	39121409
UNSPSC 20.0	39121409
UNSPSC 21.0	39121409

Approvals

Approvals

Approvals

IECEE CB Scheme / SEV / EAC / cULus Recognized

Ex Approvals

Approval details

IECEE CB Scheme		http://www.iecee.org/	CH-10653-M1
Nominal voltage UN	1000 V		
Nominal current IN	76 A		
mm ² /AWG/kcmil	16		

SEV		https://www.eurofins.ch/de/	IK-4468-M1
Nominal voltage UN	1000 V		
Nominal current IN	76 A		
mm ² /AWG/kcmil	16		

Printed-circuit board connector - ISPC 16/ 7-STF-10,16 - 1748671

Approvals

EAC		B.01687
-----	--	---------

cULus Recognized		http://database.ul.com/cgi-bin/XYV/template/LISEXT/1FRAME/index.htm	E60425-20040202
	B	C	
Nominal voltage UN	600 V	600 V	
Nominal current IN	66 A	66 A	
mm ² /AWG/kcmil	20-4	20-4	

Accessories

Accessories

Coding element

Coding profile - CP-PC RD - 1701967



Coding profile, for plugging into the coding ribs of the plug at a later date, insulating material, color: Red

Crimping tool

Crimping pliers - CRIMPFOX 6 - 1212034



Crimping pliers, for ferrules without insulating collar according to DIN 46228 Part 1 and ferrules with insulating collar according to DIN 46228 Part 4, 0.25 mm² ... 6.0 mm², lateral entry, trapezoidal crimp

Crimping pliers - CRIMPFOX 16 S - 1207983



Crimping pliers for ferrules up to 16 mm²

Screwdriver tools

Printed-circuit board connector - ISPC 16/ 7-STF-10,16 - 1748671

Accessories

Screwdriver - SZF 2-0,8X4,0 - 1204520



Actuation tool, for ST terminal blocks, also suitable for use as a bladed screwdriver, size: 0.8 x 4.0 x 100 mm, 2-component grip, with non-slip grip

Terminal marking

Marker strip - SK 5,0 WH:REEL - 0805221



Marker strip, Roll, white, unlabeled, can be labeled with: THERMOMARK ROLL 2.0, THERMOMARK ROLL, THERMOMARK ROLL X1, THERMOMARK ROLLMASTER 300/600, THERMOMARK X1.2, mounting type: adhesive, for terminal block width: 5 mm, lettering field size: continuous x 5#mm, Number of individual labels: 90000

Additional products

Feed-through header - IPC 16/ 7-GF-10,16 - 1969661



PCB headers, nominal current: 76 A, rated voltage (III/2): 1000 V, nominal cross section: 16 mm², number of positions: 7, pitch: 10.16 mm, color: green, contact surface: Silver, mounting: Wave soldering, pin layout: Linear three-way pinning, solder pin [P]: 4 mm

Feed-through header - IPC 16/ 7-GFU-10,16 - 1969988



PCB headers, nominal current: 76 A, rated voltage (III/2): 1000 V, nominal cross section: 16 mm², number of positions: 7, pitch: 10.16 mm, color: green, contact surface: Silver, mounting: Wave soldering, pin layout: Linear pinning, solder pin [P]: 4 mm, Plug direction parallel to the PCB: connector part rotated by 180° with respect to the plug axis.

Feed-through header - IPCV 16/ 7-GF-10,16 - 1969823



PCB headers, nominal current: 76 A, rated voltage (III/2): 1000 V, nominal cross section: 16 mm², number of positions: 7, pitch: 10.16 mm, color: green, contact surface: Silver, mounting: Wave soldering, pin layout: Linear pinning, solder pin [P]: 4 mm

Printed-circuit board connector - ISPC 16/ 7-STF-10,16 - 1748671

Accessories

Feed-through header - DFK-IPC 16/ 7-GF-10,16 - 1702785



Feed-through header, nominal current: 76 A, rated voltage (III/2): 1000 V, nominal cross section: 16 mm², number of positions: 7, pitch: 10.16 mm, color: green, contact surface: Silver, mounting: Wave soldering, pin layout: Linear pinning, solder pin [P]: 3.8 mm

Feed-through header - DFK-IPC 16/ 7-GFU-10,16 - 1702866



Feed-through header, nominal current: 76 A, rated voltage (III/2): 1000 V, nominal cross section: 16 mm², number of positions: 7, pitch: 10.16 mm, color: green, contact surface: Silver, mounting: Wave soldering, pin layout: Linear pinning, solder pin [P]: 4.1 mm

Feed-through header - DFK-IPC 16/ 7-GFU-SH-10,16 - 1702947



Feed-through header, nominal current: 76 A, rated voltage (III/2): 1000 V, nominal cross section: 16 mm², number of positions: 7, pitch: 10.16 mm, color: green, contact surface: Silver, mounting: Wave soldering, pin layout: Linear pinning, solder pin [P]: 4.1 mm

Feed-through header - DFK-IPCV 16/ 7-GF-10,16 - 1703263



Feed-through header, nominal current: 76 A, rated voltage (III/2): 1000 V, nominal cross section: 16 mm², number of positions: 7, pitch: 10.16 mm, color: green, contact surface: Silver, mounting: Wave soldering, pin layout: Linear pinning, solder pin [P]: 4.1 mm

Feed-through header - DFK-IPC 16/ 7-GF-SH-10,16 - 1703027



Feed-through header, nominal current: 76 A, rated voltage (III/2): 1000 V, nominal cross section: 16 mm², number of positions: 7, pitch: 10.16 mm, color: green, contact surface: Silver, mounting: Wave soldering, pin layout: Linear pinning, solder pin [P]: 4.1 mm

Printed-circuit board connector - ISPC 16/ 7-STF-10,16 - 1748671

Accessories

Feed-through plug - DFK-IPC 16/ 7-STF-10,16 - 1703823



Feed-through connector, nominal current: 76 A, rated voltage (III/2): 1000 V, nominal cross section: 16 mm², number of positions: 7, pitch: 10.16 mm, connection method: Screw connection with tension sleeve, color: green, contact surface: Silver

Feed-through plug - DFK-IPC 16/ 7-STF-SH-10,16 - 1703988



Feed-through connector, nominal current: 76 A, rated voltage (III/2): 1000 V, nominal cross section: 16 mm², number of positions: 7, pitch: 10.16 mm, connection method: Screw connection with tension sleeve, color: green, contact surface: Silver

Phoenix Contact 2020 © - all rights reserved
<http://www.phoenixcontact.com>

PHOENIX CONTACT GmbH & Co. KG
Flachsmarktstr. 8
32825 Blomberg
Germany
Tel. +49 5235 300
Fax +49 5235 3 41200
<http://www.phoenixcontact.com>

X-ON Electronics

Largest Supplier of Electrical and Electronic Components

Click to view similar products for [Pluggable Terminal Blocks](#) category:

Click to view products by [Phoenix Contact](#) manufacturer:

Other Similar products are found below :

[57.510.0053](#) [MC 1.5/ 6-ST-3.5 GY AU](#) [734-104](#) [734-302](#) [8-141-P](#) [8426620000](#) [860505](#) [860810](#) [GBPACX-12](#) [93.731.4953.0](#) [PV05-5,08-K](#)
[PVP02-5,00](#) [PVP03-3,50](#) [PVP04-3,50](#) [PVS02-5,00](#) [1-1986160-3](#) [1377680000](#) [1531000000](#) [1546228-5](#) [ELFH16150](#) [ELFP03110](#)
[ELFP10210](#) [ELFT06250](#) [ELVP03100](#) [1700101](#) [1700410](#) [1700425](#) [1702246](#) [1705229](#) [1710175](#) [1714537](#) [1717806](#) [1719600](#) [1728941](#)
[1734692](#) [1734795](#) [1736036](#) [1740194](#) [1740291](#) [1740628](#) [1740990](#) [1746952](#) [1750207](#) [1752441](#) [1752865](#) [1754115](#) [1754144](#) [1756913](#)
[1760051](#) [1760336](#)