

Printed-circuit board connector - GICV 2,5 HC/ 9-G-7,62 - 1756553

Please be informed that the data shown in this PDF Document is generated from our Online Catalog. Please find the complete data in the user's documentation. Our General Terms of Use for Downloads are valid (<http://phoenixcontact.com/download>)



PCB headers, nominal current: 16 A, rated voltage (III/2): 630 V, nominal cross section: 2.5 mm², number of positions: 9, pitch: 7.62 mm, color: green, contact surface: Tin, mounting: Wave soldering, pin layout: Linear pinning, solder pin [P]: 3.6 mm

The figure shows a 5-pos. version of the product

Your advantages

- Well-known mounting principle allows worldwide use
- Inverted header with socket contacts for touch-proof device outputs or PCB/PCB connections
- Integrated double steel spring provides additional safety in the event of temperature and power fluctuations



Key Commercial Data

Packing unit	50 pc
GTIN	
GTIN	4046356339339

Technical data

Item properties

Brief article description	Feed-through header
Plug-in system	POWER COMBICON 2,5
Type of contact	Female connector
Range of articles	GICV 2,5 HC/..-G
Pitch	7.62 mm
Number of positions	9
Mounting type	Wave soldering
Pin layout	Linear pinning
Locking	without
Number of levels	1
Number of connections	9
Number of potentials	9

Printed-circuit board connector - GICV 2,5 HC/ 9-G-7,62 - 1756553

Technical data

Electrical parameters

Nominal current	16 A
Nom. voltage	630 V
Rated voltage	630 V
Rated voltage (III/2)	630 V
Rated voltage (II/2)	1000 V
Rated surge voltage (III/3)	6 kV
Rated surge voltage (III/2)	6 kV
Rated surge voltage (II/2)	6 kV

Material data - contact

Note	WEEE/RoHS-compliant, free of whiskers according to IEC 60068-2-82/ JEDEC JESD 201
Contact material	Cu alloy
Metal surface contact area (top layer)	Tin (4 - 8 µm Sn)
Metal surface soldering area (top layer)	Tin (4 - 8 µm Sn)

Material data - housing

Housing color	green (6021)
Insulating material	PA
Insulating material group	I
CTI according to IEC 60112	600
Flammability rating according to UL 94	V0
Glow wire flammability index GWFI according to EN 60695-2-12	850
Glow wire ignition temperature GWIT according to EN 60695-2-13	775
Temperature for the ball pressure test according to EN 60695-10-2	125 °C

Dimensions for the product

Length [l]	10.2 mm
Width [w]	68.58 mm
Height [h]	22.6 mm
Pitch	7.62 mm
Height (without solder pin)	19 mm
Solder pin [P]	3.6 mm
Pin spacing	5.08 mm
Pin dimensions	0.48 x 1.14 mm

Dimensions for PCB design

Hole diameter	1.4 mm
Pin spacing	5.08 mm

Packaging information

Type of packaging	packed in cardboard
Pieces per package	50
Denomination packing units	Pcs.

Printed-circuit board connector - GICV 2,5 HC/ 9-G-7,62 - 1756553

Technical data

Ambient conditions

Ambient temperature (storage/transport)	-40 °C ... 70 °C
Ambient temperature (assembly)	-5 °C ... 100 °C
Ambient temperature (operation)	-40 °C ... 100 °C (dependent on the derating curve)

Standards and Regulations

Connection in acc. with standard	EN-VDE
	CUL
Flammability rating according to UL 94	V0

Environmental Product Compliance

China RoHS	Environmentally friendly use period: unlimited = EFUP-e
	No hazardous substances above threshold values

Drawings

Drilling diagram

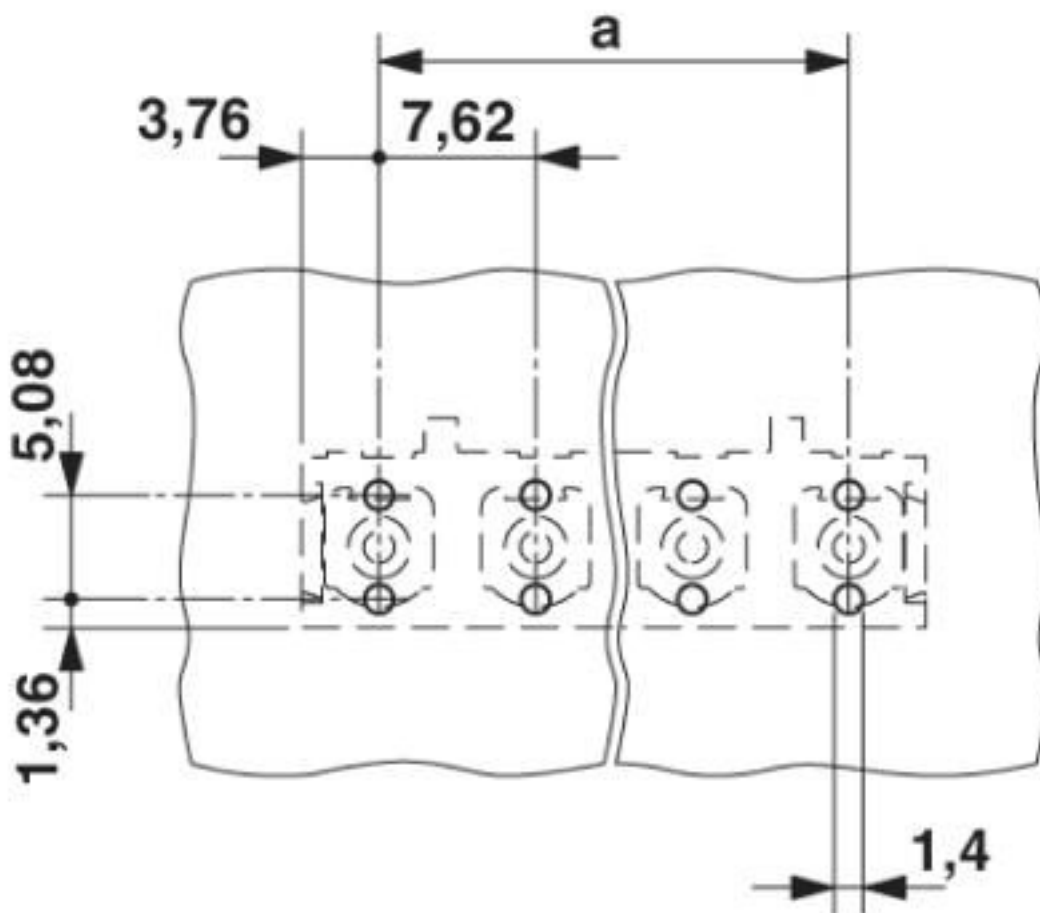

Printed-circuit board connector - GICV 2,5 HC/ 9-G-7,62 - 1756553

Dimensional drawing

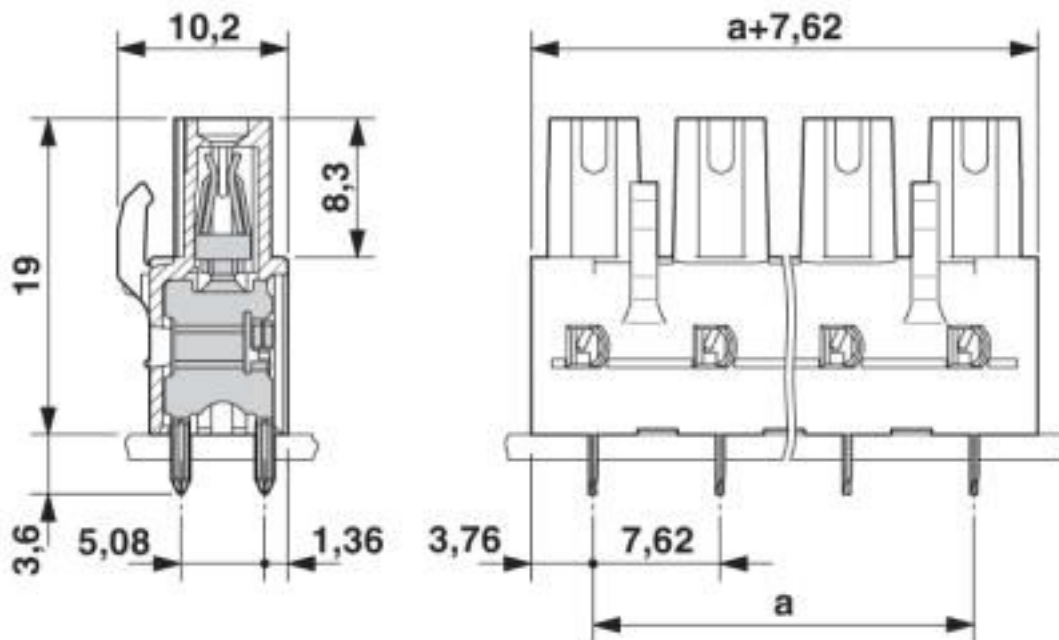

Classifications

eCl@ss

eCl@ss 10.0.1	27440402
eCl@ss 4.0	27260700
eCl@ss 4.1	27260700
eCl@ss 5.0	27260700
eCl@ss 5.1	27260700
eCl@ss 6.0	27260700
eCl@ss 7.0	27440402
eCl@ss 8.0	27440402
eCl@ss 9.0	27440402

ETIM

ETIM 3.0	EC001121
ETIM 4.0	EC002637
ETIM 5.0	EC002637
ETIM 6.0	EC002637
ETIM 7.0	EC002637

UNSPSC

UNSPSC 6.01	30211810
UNSPSC 7.0901	39121409
UNSPSC 11	39121409
UNSPSC 12.01	39121409

Printed-circuit board connector - GICV 2,5 HC/ 9-G-7,62 - 1756553

Classifications

UNSPSC

UNSPSC 13.2	39121409
UNSPSC 18.0	39121409
UNSPSC 19.0	39121409
UNSPSC 20.0	39121409
UNSPSC 21.0	39121409

Approvals

Approvals

Approvals

EAC / cULus Recognized / IECCEB Scheme / VDE Zeichengenehmigung

Ex Approvals

Approval details

EAC		B.01687
-----	--	---------

cULus Recognized		http://database.ul.com/cgi-bin/XYV/template/LISEXT/1FRAME/index.htm	E60425-19931014
	B	D	
Nominal voltage UN	250 V	300 V	
Nominal current IN	16 A	10 A	

IECCEB Scheme		http://www.iecee.org/	DE1-60988-B1B2
Nominal voltage UN	400 V		
Nominal current IN	16 A		

VDE Zeichengenehmigung		http://www2.vde.com/de/Institut/Online-Service/VDE-gepruefteProdukte/Seiten/Online-Suche.aspx	40050079
Nominal voltage UN	400 V		

Printed-circuit board connector - GICV 2,5 HC/ 9-G-7,62 - 1756553

Approvals

Nominal current I _N	16 A
--------------------------------	------

Accessories

Additional products

Plug - GIC 2,5 HCV/ 9-ST-7,62 - 1745690



PCB connector, nominal current: 16 A, rated voltage (III/2): 1000 V, nominal cross section: 2.5 mm², number of positions: 9, pitch: 7.62 mm, connection method: Screw connection with tension sleeve, color: green, contact surface: Tin

Feed-through header - GMSTBA 2,5 HC/ 9-G-7,62 - 1728921



PCB headers, nominal current: 16 A, rated voltage (III/2): 630 V, nominal cross section: 2.5 mm², number of positions: 9, pitch: 7.62 mm, color: green, contact surface: Tin, mounting: Wave soldering, pin layout: Linear pinning, solder pin [P]: 3.2 mm

Printed-circuit board connector - GMSTBVA 2,5 HC/ 9-G-7,62 - 1792423



PCB headers, nominal current: 16 A, rated voltage (III/2): 630 V, nominal cross section: 2.5 mm², number of positions: 9, pitch: 7.62 mm, color: green, contact surface: Tin, mounting: Wave soldering, pin layout: Linear pinning, solder pin [P]: 3.9 mm

X-ON Electronics

Largest Supplier of Electrical and Electronic Components

Click to view similar products for [Pluggable Terminal Blocks](#) category:

Click to view products by [Phoenix Contact](#) manufacturer:

Other Similar products are found below :

[57.510.0053](#) [MC 1.5/ 6-ST-3.5 GY AU](#) [734-104](#) [734-302](#) [8-141-P](#) [8426620000](#) [860505](#) [860810](#) [GBPACX-12](#) [93.731.4953.0](#) [PV05-5,08-K](#)
[PVP02-5,00](#) [PVP03-3,50](#) [PVP04-3,50](#) [PVS02-5,00](#) [1-1986160-3](#) [1377680000](#) [1531000000](#) [1546228-5](#) [ELFH16150](#) [ELFP03110](#)
[ELFP10210](#) [ELFT06250](#) [ELVP03100](#) [1700101](#) [1700410](#) [1700425](#) [1702246](#) [1705229](#) [1710175](#) [1714537](#) [1717806](#) [1719600](#) [1728941](#)
[1734692](#) [1734795](#) [1736036](#) [1740194](#) [1740291](#) [1740628](#) [1740990](#) [1746952](#) [1750207](#) [1752441](#) [1752865](#) [1754115](#) [1754144](#) [1756913](#)
[1760051](#) [1760336](#)