

Printed-circuit board connector - TSPC 5/ 2-STCL-7,62 - 1765418

Please be informed that the data shown in this PDF Document is generated from our Online Catalog. Please find the complete data in the user's documentation. Our General Terms of Use for Downloads are valid (<http://phoenixcontact.com/download>)



PCB connector, nominal current: 41 A, rated voltage (III/2): 1000 V, nominal cross section: 6 mm², number of positions: 2, pitch: 7.62 mm, connection method: Push-in spring connection, color: green, contact surface: Tin

The figure shows a 5-pos. version of the product

Your advantages

- ✓ Time saving push-in connection, tools not required
- ✓ Defined contact force ensures that contact remains stable over the long term
- ✓ Clamping space opened by means of fixed screwdriver enables convenient conductor connection
- ✓ Integrated double steel spring provides additional safety in the event of temperature and power fluctuations
- ✓ Potentials can be easily looped through – ideal for BUS applications
- ✓ Automatic locking and intuitive release through Lock and Release operating lever in contrasting color
- ✓ 600 V UL approval in the smallest of dimensions

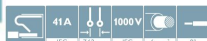

Key Commercial Data

Packing unit	10 pc
GTIN	 4 046356 440363
GTIN	4046356440363

Technical data

Item properties

Brief article description	Printed-circuit board connector
Plug-in system	POWER COMBICON 5
Type of contact	Female connector
Range of articles	TSPC 5/...-STCL
Pitch	7.62 mm
Number of positions	2
Connection method	Push-in spring connection
Locking	Click & Lock latching slide

Printed-circuit board connector - TSPC 5/ 2-STCL-7,62 - 1765418

Technical data

Item properties

Number of levels	1
Number of connections	4
Number of potentials	2

Electrical parameters

Nominal current	41 A
Nom. voltage	1000 V
Rated voltage	1000 V
Rated voltage (III/2)	1000 V
Rated voltage (II/2)	1000 V
Rated surge voltage (III/3)	8 kV
Rated surge voltage (III/2)	8 kV
Rated surge voltage (II/2)	6 kV

Connection capacity

Connection method	Push-in spring connection
pluggable	Yes
Conductor cross section solid	0.2 mm ² ... 10 mm ²
Conductor cross section flexible	0.2 mm ² ... 6 mm ²
Conductor cross section AWG / kcmil	24 ... 8
Conductor cross section flexible, with ferrule without plastic sleeve	0.25 mm ² ... 6 mm ²
Conductor cross section, flexible, with ferrule, with plastic sleeve	0.25 mm ² ... 4 mm ²
2 conductors with the same cross section, flexible, with TWIN ferrule with plastic sleeve	0.25 mm ² ... 1.5 mm ²
Stripping length	15 mm

Flange specifications

Type of locking	Clip locking
Mounting flange	Click & Lock latching slide

Material data - contact

Note	WEEE/RoHS-compliant, free of whiskers according to IEC 60068-2-82/ JEDEC JESD 201
Contact material	Cu alloy
Surface characteristics	hot-dip tin-plated
Metal surface terminal point (top layer)	Tin (4 - 8 µm Sn)
Metal surface contact area (top layer)	Tin (4 - 8 µm Sn)

Material data - housing

Housing color	green (6021)
Insulating material	PA
Insulating material group	I
CTI according to IEC 60112	600
Flammability rating according to UL 94	V0

Printed-circuit board connector - TSPC 5/ 2-STCL-7,62 - 1765418

Technical data

Material data - housing

Glow wire flammability index GWFI according to EN 60695-2-12	850
Glow wire ignition temperature GWIT according to EN 60695-2-13	775
Temperature for the ball pressure test according to EN 60695-10-2	125 °C

Material data – actuating element

Color of the actuating lever	orange (2003)
------------------------------	---------------

Dimensions for the product

Length [l]	41.45 mm
Width [w]	23.24 mm
Height [h]	35.05 mm
Pitch	7.62 mm
Height (without solder pin)	35.05 mm

Packaging information

Type of packaging	packed in cardboard
Pieces per package	10
Denomination packing units	Pcs.

Environmental Product Compliance

China RoHS	Environmentally friendly use period: unlimited = EFUP-e
	No hazardous substances above threshold values

Drawings

Dimensional drawing

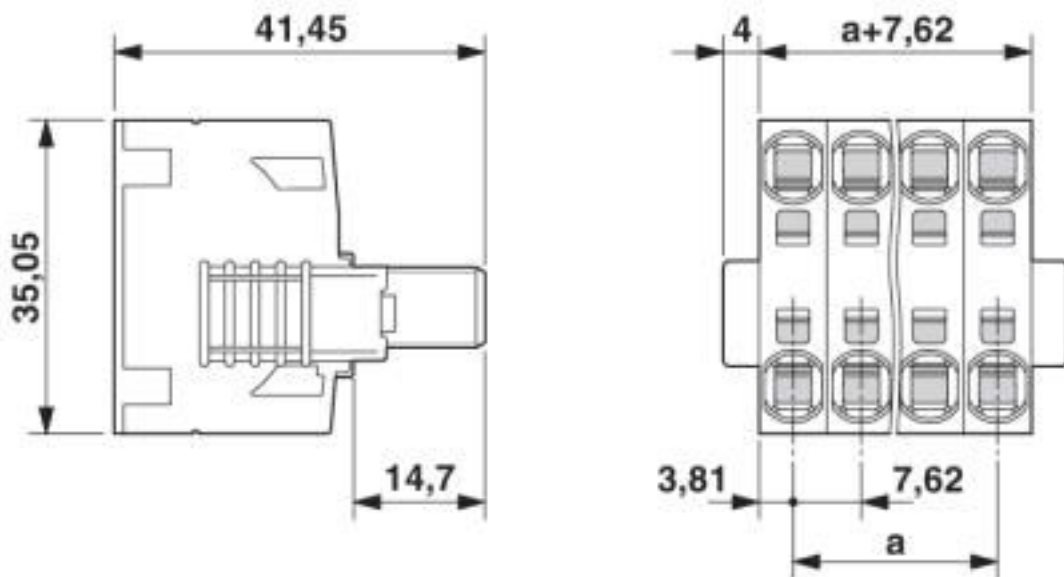

Printed-circuit board connector - TSPC 5/ 2-STCL-7,62 - 1765418

Classifications

eCl@ss

eCl@ss 10.0.1	27440309
eCl@ss 4.0	27260700
eCl@ss 4.1	27260700
eCl@ss 5.0	27260700
eCl@ss 5.1	27260700
eCl@ss 6.0	27260700
eCl@ss 7.0	27440309
eCl@ss 8.0	27440309
eCl@ss 9.0	27440309

ETIM

ETIM 3.0	EC001121
ETIM 4.0	EC002638
ETIM 5.0	EC002638
ETIM 6.0	EC002638
ETIM 7.0	EC002638

UNSPSC

UNSPSC 6.01	30211810
UNSPSC 7.0901	39121409
UNSPSC 11	39121409
UNSPSC 12.01	39121409
UNSPSC 13.2	39121409
UNSPSC 18.0	39121409
UNSPSC 19.0	39121409
UNSPSC 20.0	39121409
UNSPSC 21.0	39121409

Approvals

Approvals

Approvals

EAC / cULus Recognized

Ex Approvals

Approval details

Printed-circuit board connector - TSPC 5/ 2-STCL-7,62 - 1765418

Approvals

EAC		B.01687
-----	--	---------

cULus Recognized		http://database.ul.com/cgi-bin/XYV/template/LISEXT/1FRAME/index.htm	E60425-19920722
	B	C	
Nominal voltage UN	600 V	600 V	
Nominal current IN	31 A	31 A	
mm ² /AWG/kcmil	24-8	24-8	

Accessories

Accessories

Cable end sleeve

Ferrule - AI 4 -15 GY - 1200264



Ferrule, sleeve length: 15 mm, length: 23 mm, color: gray

Coding element

Coding profile - CP-PC RD - 1701967

Coding profile, for plugging into the coding ribs of the plug at a later date, insulating material, color: Red



Crimping tool

Crimping pliers - CRIMPFOX 6 - 1212034



Crimping pliers, for ferrules without insulating collar according to DIN 46228 Part 1 and ferrules with insulating collar according to DIN 46228 Part 4, 0.25 mm² ... 6.0 mm², lateral entry, trapezoidal crimp

Labeled terminal marker

Printed-circuit board connector - TSPC 5/ 2-STCL-7,62 - 1765418

Accessories

Marker card - SK 7,62/3,8:FORTL.ZAHLEN - 0804549



Marker card, Card, white, labeled, horizontal: consecutive numbers 1 ... 10, 11 ... 20, etc. up to 91 ... 100, mounting type: adhesive, for terminal block width: 7.62 mm, lettering field size: 7.62 x 3.8 mm

Marker card - SK 3,8 REEL P7,62 WH CUS - 0825128



Marker card, Card, can be ordered: by card, white, labeled according to customer specifications, mounting type: adhesive, for terminal block width: 7.62 mm, lettering field size: continuous x 3.8#mm

Screwdriver tools

Screwdriver - SZF 1-0,6X3,5 - 1204517



Actuation tool, for ST terminal blocks, also suitable for use as a bladed screwdriver, size: 0.6 x 3.5 x 100 mm, 2-component grip, with non-slip grip

Terminal marking

Marker card - SK U/3,8 WH:UNBEDRUCKT - 0803906



Marker card, Sheet, white, unlabeled, can be labeled with: PLOTMARK, CMS-P1-PLOTTER, Office printing systems, mounting type: adhesive, for terminal block width: 210 mm, lettering field size: 186 x 3.8 mm, Number of individual labels: 1440

Marker strip - SK 3,8 WH:REEL - 0805218



Marker strip, Roll, white, unlabeled, can be labeled with: THERMOMARK ROLL 2.0, THERMOMARK ROLL, THERMOMARK ROLL X1, THERMOMARK ROLLMASTER 300/600, THERMOMARK X1.2, mounting type: adhesive, for terminal block width: 90000 mm, lettering field size: continuous x 3.8#mm, Number of individual labels: 210000

Additional products

Printed-circuit board connector - TSPC 5/ 2-STCL-7,62 - 1765418

Accessories

Printed-circuit board connector - IPC 5/ 2-STGCL-7,62 - 1718261



PCB connector, nominal current: 41 A, rated voltage (III/2): 1000 V, nominal cross section: 6 mm², number of positions: 2, pitch: 7.62 mm, connection method: Screw connection with tension sleeve, color: green, contact surface: Tin

Printed-circuit board connector - ISPC 5/ 2-STGCL-7,62 - 1748862



PCB connector, nominal current: 41 A, rated voltage (III/2): 1000 V, nominal cross section: 6 mm², number of positions: 2, pitch: 7.62 mm, connection method: Push-in spring connection, color: green, contact surface: Tin

Printed-circuit board connector - PC 5/ 2-G-7,62 - 1720466



PCB headers, nominal current: 41 A, rated voltage (III/2): 630 V, nominal cross section: 6 mm², number of positions: 2, pitch: 7.62 mm, color: green, contact surface: Tin, mounting: Wave soldering, pin layout: Linear pinning, solder pin [P]: 5 mm

Printed-circuit board connector - PC 5/ 2-GU-7,62 - 1720686



PCB headers, nominal current: 41 A, rated voltage (III/2): 630 V, nominal cross section: 6 mm², number of positions: 2, pitch: 7.62 mm, color: green, contact surface: Tin, mounting: Wave soldering, pin layout: Linear pinning, solder pin [P]: 4.2 mm

Printed-circuit board connector - PCV 5/ 2-G-7,62 - 1720576



PCB headers, nominal current: 41 A, rated voltage (III/2): 630 V, nominal cross section: 6 mm², number of positions: 2, pitch: 7.62 mm, color: green, contact surface: Tin, mounting: Wave soldering, pin layout: Linear pinning, solder pin [P]: 5 mm

Printed-circuit board connector - TSPC 5/ 2-STCL-7,62 - 1765418

Accessories

Printed-circuit board connector - DFK-PC 5/ 2-G-7,62 - 1727582



Feed-through header, nominal current: 41 A, rated voltage (III/2): 630 V, nominal cross section: 6 mm², number of positions: 2, pitch: 7.62 mm, color: green, contact surface: Tin, mounting: Wave soldering, pin layout: Linear pinning, solder pin [P]: 4.9 mm

Printed-circuit board connector - DFK-PC 5/ 2-GU-7,62 - 1727809



Feed-through header, nominal current: 41 A, rated voltage (III/2): 630 V, nominal cross section: 6 mm², number of positions: 2, pitch: 7.62 mm, color: green, contact surface: Tin, mounting: Wave soldering, pin layout: Linear pinning, solder pin [P]: 4.26 mm

Printed-circuit board connector - DFK-PCV 5/ 2-G-7,62 - 1716289



Feed-through header, nominal current: 41 A, rated voltage (III/2): 630 V, nominal cross section: 6 mm², number of positions: 2, pitch: 7.62 mm, color: green, contact surface: Tin, mounting: Wave soldering, pin layout: Linear pinning, solder pin [P]: 5 mm

Feed-through plug - DFK-PC 5/ 2-ST-7,62 - 1716506



Feed-through connector, nominal current: 41 A, rated voltage (III/2): 1000 V, nominal cross section: 6 mm², number of positions: 2, pitch: 7.62 mm, connection method: Screw connection with tension sleeve, color: green, contact surface: Tin

X-ON Electronics

Largest Supplier of Electrical and Electronic Components

Click to view similar products for [Pluggable Terminal Blocks](#) category:

Click to view products by [Phoenix Contact](#) manufacturer:

Other Similar products are found below :

[57.510.0053](#) [MC 1.5/ 6-ST-3.5 GY AU](#) [734-104](#) [734-302](#) [8-141-P](#) [8426620000](#) [860505](#) [860810](#) [GBPACX-12](#) [93.731.4953.0](#) [PV05-5,08-K](#)
[PVP02-5,00](#) [PVP03-3,50](#) [PVP04-3,50](#) [PVS02-5,00](#) [1-1986160-3](#) [1377680000](#) [1531000000](#) [1546228-5](#) [ELFH16150](#) [ELFP03110](#)
[ELFP10210](#) [ELFT06250](#) [ELVP03100](#) [1700101](#) [1700410](#) [1700425](#) [1702246](#) [1705229](#) [1710175](#) [1714537](#) [1717806](#) [1719600](#) [1728941](#)
[1734692](#) [1734795](#) [1736036](#) [1740194](#) [1740291](#) [1740628](#) [1740990](#) [1746952](#) [1750207](#) [1752441](#) [1752865](#) [1754115](#) [1754144](#) [1756913](#)
[1760051](#) [1760336](#)