

Feed-through header - GMSTBA 2,5/ 8-G-7,62 - 1766291

Please be informed that the data shown in this PDF Document is generated from our Online Catalog. Please find the complete data in the user's documentation. Our General Terms of Use for Downloads are valid (<http://phoenixcontact.com/download>)

PCB headers, nominal current: 12 A, rated voltage (III/2): 630 V, nominal cross section: 2.5 mm², number of positions: 8, pitch: 7.62 mm, color: green, contact surface: Tin, mounting: Wave soldering, pin layout: Linear pinning, solder pin [P]: 3.2 mm



The figure shows a 10-position version of the product

Your advantages

- Maximum flexibility when it comes to device design – one header for connectors with different connection technologies
- Well-known mounting principle allows worldwide use
- Larger pitch for increased voltage requirements
- Closed contour for optimum stability of the plug-in connection
- Plug-in direction parallel to the PCB



Key Commercial Data

Packing unit	100 pc
Minimum order quantity	100 pc
GTIN	
GTIN	4017918032319

Technical data

Item properties

Brief article description	Feed-through header
Plug-in system	CLASSIC COMBICON
Type of contact	Male connector
Range of articles	GMSTBA 2,5/..-G
Pitch	7.62 mm
Number of positions	8
Mounting type	Wave soldering
Pin layout	Linear pinning
Locking	without

Feed-through header - GMSTBA 2,5/ 8-G-7,62 - 1766291

Technical data

Item properties

Number of levels	1
Number of connections	8
Number of potentials	8

Electrical parameters

Nominal current	12 A
Nom. voltage	630 V
Rated voltage	400 V
Rated voltage (III/2)	630 V
Rated voltage (II/2)	630 V
Rated surge voltage (III/3)	6 kV
Rated surge voltage (III/2)	6 kV
Rated surge voltage (II/2)	6 kV

Material data - contact

Note	WEEE/RoHS-compliant, free of whiskers according to IEC 60068-2-82/ JEDEC JESD 201
Contact material	Cu alloy
Surface characteristics	Tin-plated
Metal surface contact area (top layer)	Tin (3 - 5 µm Sn)
Metal surface contact area (middle layer)	Nickel (1.3 - 3 µm Ni),
Metal surface soldering area (top layer)	Tin (3 - 5 µm Sn)
Metal surface soldering area (middle layer)	Nickel (1.3 - 3 µm Ni)

Material data - housing

Housing color	green (6021)
Insulating material	PA
Insulating material group	I
CTI according to IEC 60112	600
Flammability rating according to UL 94	V0
Glow wire flammability index GWFI according to EN 60695-2-12	850
Glow wire ignition temperature GWIT according to EN 60695-2-13	775
Temperature for the ball pressure test according to EN 60695-10-2	125 °C

Dimensions for the product

Length [l]	12 mm
Width [w]	60.96 mm
Height [h]	11.8 mm
Pitch	7.62 mm
Height (without solder pin)	8.6 mm
Solder pin [P]	3.2 mm
Pin dimensions	1 x 1 mm

Dimensions for PCB design

Feed-through header - GMSTBA 2,5/ 8-G-7,62 - 1766291

Technical data

Dimensions for PCB design

Hole diameter	1.4 mm
---------------	--------

Packaging information

Type of packaging	packed in cardboard
Pieces per package	100
Denomination packing units	Pcs.

General product information

Note	In accordance with IEC 61984, COMBICON connectors have no switching power (COC). During designated use, they must not be plugged in or disconnected when carrying voltage or under load.
	In accordance with IEC 61984, COMBICON connectors have no switching power (COC). During designated use, they must not be plugged in or disconnected when carrying voltage or under load.

Ambient conditions

Ambient temperature (storage/transport)	-40 °C ... 70 °C
Ambient temperature (assembly)	-5 °C ... 100 °C
Ambient temperature (operation)	-40 °C ... 100 °C (dependent on the derating curve)

Air clearances and creepage distances

Clearances and creepage distances	IEC 60664-1:2007-04
Specification	IEC 60664-1:2007-04
Minimum clearance - inhomogeneous field (III/3)	5.5 mm
Minimum clearance - inhomogeneous field (III/2)	5.5 mm
Minimum clearance - inhomogeneous field (II/2)	5.5 mm
Minimum creepage distance value (III/3)	6.3 mm
Minimum creepage distance value (III/2)	3.2 mm
Minimum creepage distance value (II/2)	5 mm

Mechanical tests (A)

Test specification	IEC 61984
Insertion strength per pos. approx.	9 N
Withdraw strength per pos. approx.	6 N
Polarization when inserted requirement >20 N	Test passed
Contact holder in insert requirements >20 N	Test passed

Durability tests (B)

Specification	IEC 60512-9-1:2010-03
Contact resistance R ₁	1.4 mΩ
Insertion/withdrawal cycles	25
Contact resistance R ₂	1.5 mΩ
Impulse withstand voltage at sea level	7.3 kV
Power-frequency withstand voltage	3.31 kV
Insulation resistance, neighboring positions	2,2 TΩ

Feed-through header - GMSTBA 2,5/ 8-G-7,62 - 1766291

Technical data

Thermal tests (C)

Specification	IEC 60512-5-1:2002-02
Number of positions	12
Conductor cross section	2.5 mm ²
Test current	12 A DC
Upper limiting temperature requirements <100 °C	Test passed

Climatic tests (D)

Specification	ISO 6988:1985-02
Cold stress	-40 °C/2 h
Thermal stress	100 °C/168 h
Corrosive stress	0.2 dm ³ SO ₂ on 300 dm ³ /40 °C/1 cycle
Impulse withstand voltage at sea level	7.3 kV
Power-frequency withstand voltage	3.31 kV

Environmental and durability tests (E)

Specification	IEC 61984:2008-10
Result, degree of protection, IP code	Finger safety with IP20 test finger

Vibration test

Specification	IEC 60068-2-6:2007-12
Result	Test passed
Frequency	10 - 150 - 10 Hz
Sweep speed	1 octave/min
Amplitude	0.35 mm (10 - 60.1 Hz)
Acceleration	5 g (60.1 - 150 Hz)
Test duration per axis	2.5 h

Standards and Regulations

Connection in acc. with standard	EN-VDE
	CSA
Flammability rating according to UL 94	V0

Environmental Product Compliance

China RoHS	Environmentally friendly use period: unlimited = EFUP-e
	No hazardous substances above threshold values

Drawings

Feed-through header - GMSTBA 2,5/ 8-G-7,62 - 1766291

Drilling diagram

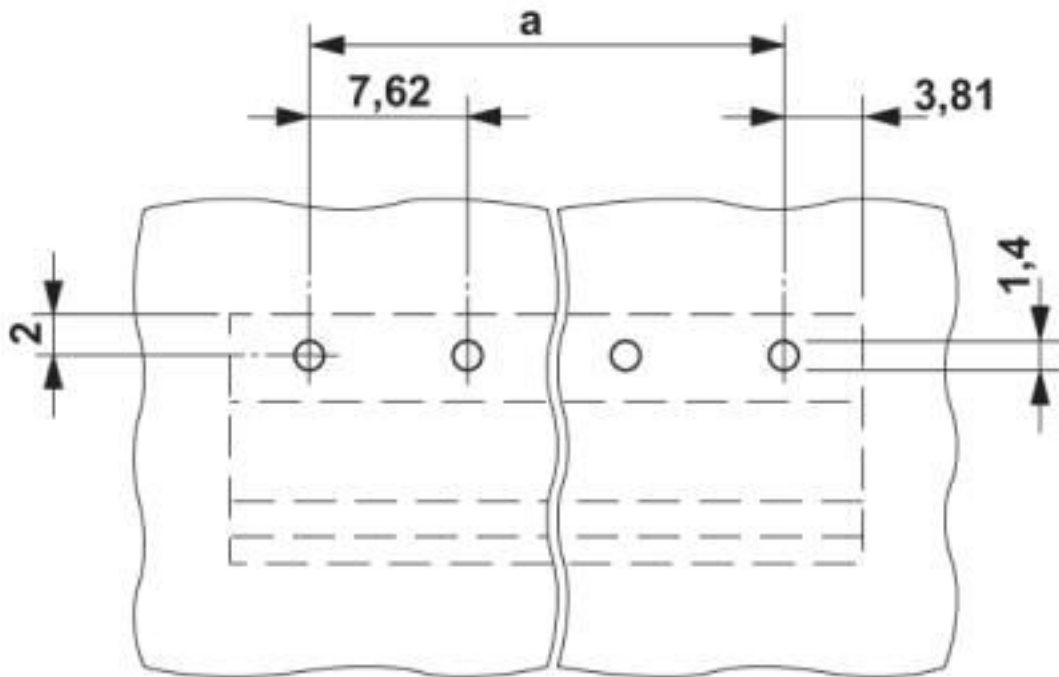

Diagram

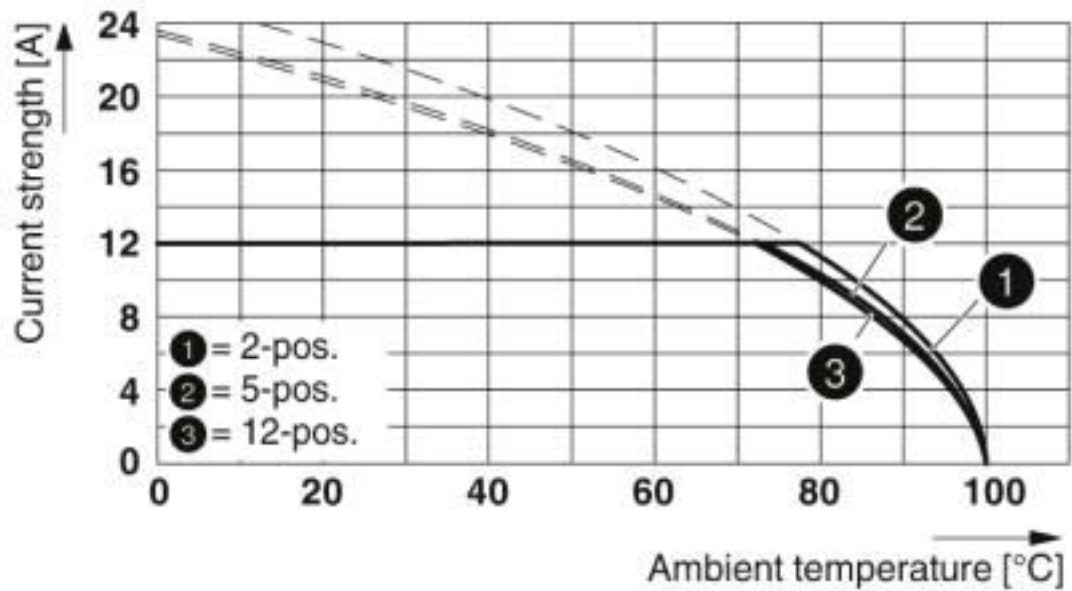

Type: GMSTB 2,5/...-ST-7,62 with GMSTBA 2,5/...-G-7,62

Feed-through header - GMSTBA 2,5/ 8-G-7,62 - 1766291

Dimensional drawing

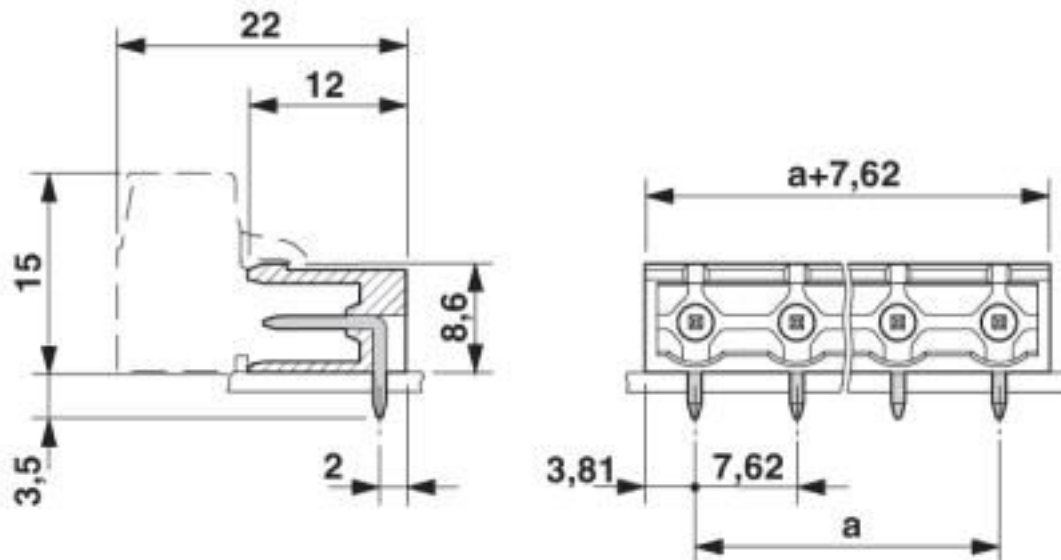

Classifications

eCl@ss

eCl@ss 10.0.1	27440402
eCl@ss 4.0	27260700
eCl@ss 4.1	27260700
eCl@ss 5.0	27260700
eCl@ss 5.1	27260700
eCl@ss 6.0	27260700
eCl@ss 7.0	27440402
eCl@ss 8.0	27440402
eCl@ss 9.0	27440402

ETIM

ETIM 3.0	EC001121
ETIM 4.0	EC002637
ETIM 5.0	EC002637
ETIM 6.0	EC002637
ETIM 7.0	EC002637

UNSPSC

UNSPSC 6.01	30211810
UNSPSC 7.0901	39121409
UNSPSC 11	39121409
UNSPSC 12.01	39121409
UNSPSC 13.2	39121409
UNSPSC 18.0	39121409

Feed-through header - GMSTBA 2,5/ 8-G-7,62 - 1766291

Classifications

UNSPSC

UNSPSC 19.0	39121409
UNSPSC 20.0	39121409
UNSPSC 21.0	39121409

Approvals

Approvals

Approvals

CSA / IECCEB CB Scheme / EAC / cULus Recognized / VDE Zeichengenehmigung

Ex Approvals

Approval details

CSA		http://www.csagroup.org/services-industries/product-listing/	13631
	B	D	
Nominal voltage UN	300 V	300 V	
Nominal current IN	10 A	10 A	

IECEE CB Scheme		http://www.iecee.org/	DE1-60988-B1B2
Nominal voltage UN	400 V		
Nominal current IN	12 A		

EAC		B.01687
-----	---	---------

cULus Recognized		http://database.ul.com/cgi-bin/XYV/template/LISEXT/1FRAME/index.htm	E60425-19931013
	B	D	
Nominal voltage UN	300 V	300 V	
Nominal current IN	15 A	10 A	

Feed-through header - GMSTBA 2,5/ 8-G-7,62 - 1766291

Approvals

VDE Zeichengenehmigung		http://www2.vde.com/de/Institut/Online-Service/VDE-gepruefteProdukte/Seiten/Online-Suche.aspx	40050648
Nominal voltage UN		400 V	
Nominal current IN		12 A	

Accessories

Accessories

Coding element

Coding section - CR-MSTB - 1734401

Coding section, inserted into the recess in the header or the inverted plug, red insulating material



Filler plug

Accessories - MSTB-BL - 1755477



Keying cap, for forming sections, plugs onto header pin, green insulating material

Labeled terminal marker

Marker card - SK 7,62/3,8:FORTL.ZAHLEN - 0804549

Marker card, Card, white, labeled, horizontal: consecutive numbers 1 ... 10, 11 ... 20, etc. up to 91 ... 100, mounting type: adhesive, for terminal block width: 7.62 mm, lettering field size: 7.62 x 3.8 mm



Additional products

Feed-through header - GMSTBA 2,5/ 8-G-7,62 - 1766291

Accessories

Printed-circuit board connector - GMSTB 2,5/ 8-ST-7,62 - 1767067

PCB connector, nominal current: 12 A, rated voltage (III/2): 630 V, nominal cross section: 2.5 mm², number of positions: 8, pitch: 7.62 mm, connection method: Screw connection with tension sleeve, color: green, contact surface: Tin



Printed-circuit board connector - FRONT-GMSTB 2,5/ 8-ST-7,62 - 1806177

PCB connector, nominal current: 12 A, rated voltage (III/2): 630 V, nominal cross section: 2.5 mm², number of positions: 8, pitch: 7.62 mm, connection method: Front screw connection, color: green, contact surface: Tin



Printed-circuit board connector - GMVSTBW 2,5/ 8-ST-7,62 - 1832471

PCB connector, nominal current: 12 A, rated voltage (III/2): 630 V, nominal cross section: 2.5 mm², number of positions: 8, pitch: 7.62 mm, connection method: Screw connection with tension sleeve, color: green, contact surface: Tin



Printed-circuit board connector - GMVSTBR 2,5/ 8-ST-7,62 - 1832581

PCB connector, nominal current: 12 A, rated voltage (III/2): 630 V, nominal cross section: 2.5 mm², number of positions: 8, pitch: 7.62 mm, connection method: Screw connection with tension sleeve, color: green, contact surface: Tin



Printed-circuit board connector - GFKC 2,5/ 8-ST-7,62 - 1939691

PCB connector, nominal current: 12 A, rated voltage (III/2): 630 V, nominal cross section: 2.5 mm², number of positions: 8, pitch: 7.62 mm, connection method: Push-in spring connection, color: green, contact surface: Tin, COMBICON connectors may only be activated under no load conditions. If for operating reasons small loads must be switched, experimental values are available upon request.



Phoenix Contact 2020 © - all rights reserved
<http://www.phoenixcontact.com>

PHOENIX CONTACT GmbH & Co. KG
Flachsmarktstr. 8
32825 Blomberg
Germany
Tel. +49 5235 300
Fax +49 5235 3 41200
<http://www.phoenixcontact.com>

X-ON Electronics

Largest Supplier of Electrical and Electronic Components

Click to view similar products for [Pluggable Terminal Blocks](#) category:

Click to view products by [Phoenix Contact](#) manufacturer:

Other Similar products are found below :

[57.510.0053](#) [MC 1.5/ 6-ST-3.5 GY AU](#) [734-104](#) [734-302](#) [8-141-P](#) [8426620000](#) [860505](#) [860516](#) [860810](#) [GBPACX-12](#) [93.731.4953.0](#) [PV05-5,08-K](#) [PVP02-5,00](#) [PVP03-3,50](#) [PVP04-3,50](#) [PVS02-5,00](#) [1-1986160-3](#) [1377680000](#) [1531000000](#) [1546228-5](#) [ELFH16150](#) [ELFP03110](#) [ELFP10210](#) [ELFT06250](#) [ELVP03100](#) [1700101](#) [1700410](#) [1700425](#) [1702246](#) [1705229](#) [1710175](#) [1714537](#) [1717806](#) [1719600](#) [1728941](#) [1734692](#) [1734795](#) [1736036](#) [1740194](#) [1740291](#) [1740628](#) [1740990](#) [1746952](#) [1750207](#) [1752441](#) [1752865](#) [1754115](#) [1754144](#) [1756913](#) [1760051](#)