

Printed-circuit board connector - MC 1,5/ 6-STZ2-3,81 - 1767694

Please be informed that the data shown in this PDF Document is generated from our Online Catalog. Please find the complete data in the user's documentation. Our General Terms of Use for Downloads are valid (<http://phoenixcontact.com/download>)



PCB connector, nominal current: 8 A, rated voltage (III/2): 160 V, nominal cross section: 1.5 mm², number of positions: 6, pitch: 3.81 mm, connection method: Screw connection with tension sleeve, color: green, contact surface: Tin

The figure shows the 10-position version

Your advantages

- Well-known connection principle allows worldwide use
- Low temperature rise, thanks to maximum contact force
- Allows connection of two conductors
- Pull-out aid facilitates handling and allows the tensile force to be reduced at the contact point

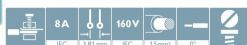

Key Commercial Data

Packing unit	50 pc
GTIN	
GTIN	4046356436540

Technical data

Dimensions

Length [l]	41 mm
Width [w]	23.65 mm
Height [h]	11.6 mm
Pitch	3.81 mm
Dimension a	19.05 mm

General

Range of articles	MC 1,5/...-STZ
Number of positions	6
Connection method	Screw connection with tension sleeve
Rated surge voltage (III/3)	2.5 kV
Rated surge voltage (III/2)	2.5 kV

Printed-circuit board connector - MC 1,5/ 6-STZ2-3,81 - 1767694

Technical data

General

Rated surge voltage (II/2)	2.5 kV
Rated voltage (III/3)	160 V
Rated voltage (III/2)	160 V
Rated voltage (II/2)	320 V
Connection in acc. with standard	EN-VDE
Nominal current I_N	8 A
Nominal cross section	1.5 mm ²
Internal cylindrical gage	A1
Stripping length	7 mm
Screw thread	M2
Tightening torque, min	0.22 Nm
Tightening torque max	0.25 Nm

Connection data

Conductor cross section solid min.	0.14 mm ²
Conductor cross section solid max.	1.5 mm ²
Conductor cross section flexible min.	0.14 mm ²
Conductor cross section flexible max.	1.5 mm ²
Conductor cross section flexible, with ferrule without plastic sleeve min.	0.25 mm ²
Conductor cross section flexible, with ferrule without plastic sleeve max.	1.5 mm ²
Conductor cross section flexible, with ferrule with plastic sleeve min.	0.25 mm ²
Conductor cross section flexible, with ferrule with plastic sleeve max.	0.5 mm ²
Conductor cross section AWG min.	28
Conductor cross section AWG max.	16
2 conductors with same cross section, solid min.	0.08 mm ²
2 conductors with same cross section, solid max.	0.5 mm ²
2 conductors with same cross section, stranded min.	0.08 mm ²
2 conductors with same cross section, stranded max.	0.75 mm ²
Two conductors with the same cross section stranded, with ferrule and without plastic sleeve, minimum	0.25 mm ²
Two conductors with the same cross section stranded, with ferrule and without plastic sleeve, maximum	0.34 mm ²
Two conductors with the same cross section, flexible, with TWIN ferrules, with plastic sleeve, minimum	0.5 mm ²
Two conductors with the same cross section, flexible, with TWIN ferrules, with plastic sleeve, maximum	0.5 mm ²
Minimum AWG according to UL/CUL	30
Maximum AWG according to UL/CUL	14

Standards and Regulations

Connection in acc. with standard	EN-VDE
	CUL

Environmental Product Compliance

Printed-circuit board connector - MC 1,5/ 6-STZ2-3,81 - 1767694

Technical data

Environmental Product Compliance

REACH SVHC	Lead 7439-92-1
China RoHS	Environmentally Friendly Use Period = 50 years
	For details about hazardous substances go to tab "Downloads", Category "Manufacturer's declaration"

Drawings

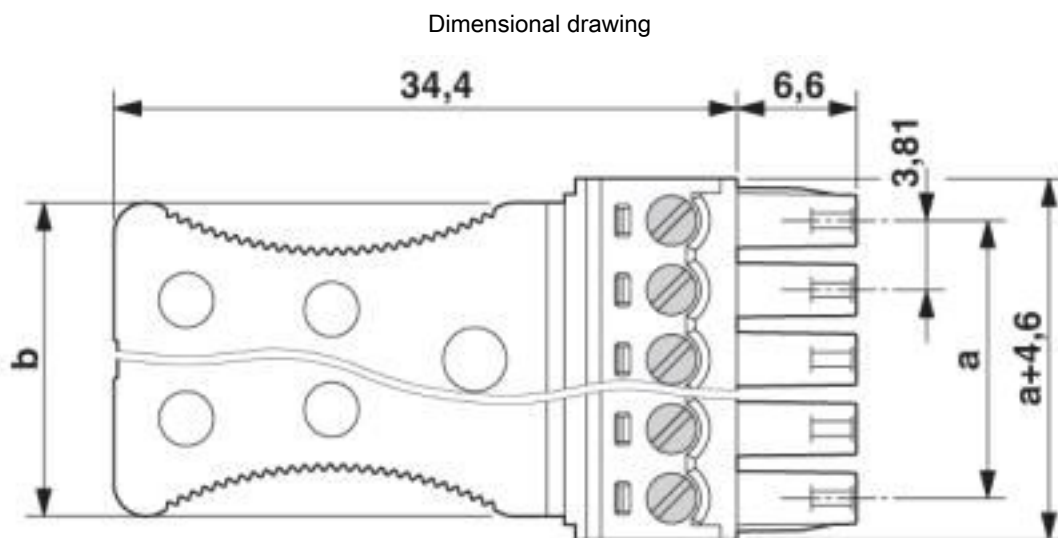

Classifications

eCl@ss

eCl@ss 10.0.1	27440309
eCl@ss 4.0	27260700
eCl@ss 4.1	27260700
eCl@ss 5.0	27260700
eCl@ss 5.1	27260700
eCl@ss 6.0	27260700
eCl@ss 7.0	27440309
eCl@ss 8.0	27440309
eCl@ss 9.0	27440309

ETIM

ETIM 3.0	EC001121
ETIM 4.0	EC002638
ETIM 5.0	EC002638
ETIM 6.0	EC002638
ETIM 7.0	EC002638

Printed-circuit board connector - MC 1,5/ 6-STZ2-3,81 - 1767694

Classifications

UNSPSC

UNSPSC 6.01	30211810
UNSPSC 7.0901	39121409
UNSPSC 11	39121409
UNSPSC 12.01	39121409
UNSPSC 13.2	39121409
UNSPSC 18.0	39121409
UNSPSC 19.0	39121409
UNSPSC 20.0	39121409
UNSPSC 21.0	39121409

Approvals

Approvals

Approvals

IECEE CB Scheme / VDE Gutachten mit Fertigungsüberwachung / EAC / cULus Recognized

Ex Approvals

Approval details

IECEE CB Scheme		http://www.iecee.org/	DE1-60987-B1B2
Nominal voltage UN	160 V		
Nominal current IN	8 A		
mm ² /AWG/kcmil	0.2-1.5		

VDE Gutachten mit Fertigungsüberwachung		http://www2.vde.com/de/Institut/Online-Service/VDE-gepruefteProdukte/Seiten/Online-Suche.aspx	40011723
Nominal voltage UN	160 V		
Nominal current IN	8 A		
mm ² /AWG/kcmil	0.2-1.5		

EAC		B.01687
-----	---	---------

Printed-circuit board connector - MC 1,5/ 6-STZ2-3,81 - 1767694

Approvals

cULus Recognized		http://database.ul.com/cgi-bin/XYV/template/LISEXT/1FRAME/index.htm E60425-20110128
	B	D
Nominal voltage UN	300 V	300 V
Nominal current IN	8 A	8 A
mm ² /AWG/kcmil	30-14	30-14

Phoenix Contact 2020 © - all rights reserved
<http://www.phoenixcontact.com>

PHOENIX CONTACT GmbH & Co. KG
Flachsmarktstr. 8
32825 Blomberg
Germany
Tel. +49 5235 300
Fax +49 5235 3 41200
<http://www.phoenixcontact.com>

X-ON Electronics

Largest Supplier of Electrical and Electronic Components

Click to view similar products for [Pluggable Terminal Blocks](#) category:

Click to view products by [Phoenix Contact](#) manufacturer:

Other Similar products are found below :

[57.510.0053](#) [MC 1.5/ 6-ST-3.5 GY AU](#) [734-104](#) [734-302](#) [8-141-P](#) [8426620000](#) [860505](#) [860516](#) [860810](#) [GBPACX-12](#) [93.731.4953.0](#) [PV05-5,08-K](#) [PVP02-5,00](#) [PVP03-3,50](#) [PVP04-3,50](#) [PVS02-5,00](#) [1-1986160-3](#) [1377680000](#) [1531000000](#) [1546228-5](#) [ELFH16150](#) [ELFP03110](#) [ELFP10210](#) [ELFT06250](#) [ELVP03100](#) [1700101](#) [1700410](#) [1700425](#) [1702246](#) [1705229](#) [1710175](#) [1714537](#) [1717806](#) [1719600](#) [1728941](#) [1734692](#) [1734795](#) [1736036](#) [1740194](#) [1740291](#) [1740628](#) [1740990](#) [1746952](#) [1750207](#) [1752441](#) [1752865](#) [1754115](#) [1754144](#) [1756913](#) [1760051](#)