

# Printed-circuit board connector - SMSTB 2,5/12-G - 1769337

Please be informed that the data shown in this PDF Document is generated from our Online Catalog. Please find the complete data in the user's documentation. Our General Terms of Use for Downloads are valid (<http://phoenixcontact.com/download>)

PCB headers, nominal current: 12 A, rated voltage (III/2): 320 V, nominal cross section: 2.5 mm<sup>2</sup>, number of positions: 12, pitch: 5 mm, color: green, contact surface: Tin, mounting: Wave soldering, pin layout: Linear pinning, solder pin [P]: 3.5 mm



The figure shows a 10-position version of the product

## Your advantages

- Maximum flexibility when it comes to device design – one header for connectors with different connection technologies
- Well-known mounting principle allows worldwide use
- Angled connection enables multi-row arrangement on the PCB



## Key Commercial Data

Packing unit	50 pc
Minimum order quantity	50 pc
GTIN	 4 017918 034658
GTIN	4017918034658

## Technical data

### Item properties

Brief article description	Feed-through header
Plug-in system	CLASSIC COMBICON
Type of contact	Male connector
Range of articles	SMSTB 2,5/..-G
Pitch	5 mm
Number of positions	12
Mounting type	Wave soldering
Pin layout	Linear pinning
Locking	without
Number of levels	1
Number of connections	12

# Printed-circuit board connector - SMSTB 2,5/12-G - 1769337

## Technical data

### Item properties

Number of potentials	12
----------------------	----

### Electrical parameters

Nominal current	12 A
Nom. voltage	320 V
Rated voltage	320 V
Rated voltage (III/2)	320 V
Rated voltage (II/2)	630 V
Rated surge voltage (III/3)	4 kV
Rated surge voltage (III/2)	4 kV
Rated surge voltage (II/2)	4 kV

### Material data - contact

Note	WEEE/RoHS-compliant, free of whiskers according to IEC 60068-2-82/ JEDEC JESD 201
Contact material	Cu alloy
Surface characteristics	Tin-plated
Metal surface contact area (top layer)	Tin (5 - 7 µm Sn)
Metal surface contact area (middle layer)	Nickel (2 - 3 µm Ni),
Metal surface soldering area (top layer)	Tin (5 - 7 µm Sn)
Metal surface soldering area (middle layer)	Nickel (2 - 3 µm Ni)

### Material data - housing

Housing color	green (6021)
Insulating material	PA
Insulating material group	I
CTI according to IEC 60112	600
Flammability rating according to UL 94	V0
Glow wire flammability index GWFI according to EN 60695-2-12	850
Glow wire ignition temperature GWIT according to EN 60695-2-13	775
Temperature for the ball pressure test according to EN 60695-10-2	125 °C

### Dimensions for the product

Length [ l ]	16.5 mm
Width [ w ]	60 mm
Height [ h ]	18.3 mm
Pitch	5 mm
Height (without solder pin)	14.8 mm
Solder pin [P]	3.5 mm
Pin dimensions	1 x 1 mm

### Dimensions for PCB design

Hole diameter	1.4 mm
---------------	--------

# Printed-circuit board connector - SMSTB 2,5/12-G - 1769337

## Technical data

### Packaging information

Type of packaging	packed in cardboard
Pieces per package	50
Denomination packing units	Pcs.

### Ambient conditions

Ambient temperature (storage/transport)	-40 °C ... 70 °C
Ambient temperature (assembly)	-5 °C ... 100 °C
Ambient temperature (operation)	-40 °C ... 100 °C (dependent on the derating curve)

### Air clearances and creepage distances

Clearances and creepage distances	IEC 60664-1:2007-04
Specification	IEC 60664-1:2007-04
Minimum clearance - inhomogeneous field (III/3)	3 mm
Minimum clearance - inhomogeneous field (III/2)	3 mm
Minimum clearance - inhomogeneous field (II/2)	3 mm
Minimum creepage distance value (III/3)	4 mm
Minimum creepage distance value (III/2)	1.6 mm
Minimum creepage distance value (II/2)	3.2 mm

### Mechanical tests (A)

Test specification	IEC 61984
Insertion strength per pos. approx.	8 N
Withdraw strength per pos. approx.	6 N
Polarization when inserted requirement >20 N	Test passed
Contact holder in insert requirements >20 N	Test passed

### Durability tests (B)

Specification	IEC 60512-9-1:2010-03
Contact resistance R <sub>1</sub>	1 mΩ
Insertion/withdrawal cycles	25
Contact resistance R <sub>2</sub>	1.2 mΩ
Impulse withstand voltage at sea level	4.8 kV
Power-frequency withstand voltage	2.21 kV
Insulation resistance, neighboring positions	> 10 GΩ

### Thermal tests (C)

Specification	IEC 60512-5-1:2002-02
Number of positions	18
Conductor cross section	2.5 mm <sup>2</sup>
Test current	12 A
Upper limiting temperature requirements <100 °C	Test passed

### Climatic tests (D)

Specification	ISO 6988:1985-02
---------------	------------------

# Printed-circuit board connector - SMSTB 2,5/12-G - 1769337

## Technical data

### Climatic tests (D)

Cold stress	-40 °C/2 h
Thermal stress	100 °C/168 h
Corrosive stress	0.2 dm <sup>3</sup> SO <sub>2</sub> on 300 dm <sup>3</sup> /40 °C/1 cycle
Impulse withstand voltage at sea level	4.8 kV
Power-frequency withstand voltage	2.21 kV

### Environmental and durability tests (E)

Specification	IEC 61984:2008-10
Result, degree of protection, IP code	Finger safety with IP20 test finger

### Vibration test

Specification	IEC 60068-2-6:2007-12
Result	Test passed
Frequency	10 - 150 - 10 Hz
Sweep speed	1 octave/min
Amplitude	0.35 mm (10 - 60.1 Hz)
Acceleration	5 g (60.1 - 150 Hz)
Test duration per axis	2.5 h

### Standards and Regulations

Connection in acc. with standard	EN-VDE
	CSA
Flammability rating according to UL 94	V0

### Environmental Product Compliance

China RoHS	Environmentally friendly use period: unlimited = EFUP-e
	No hazardous substances above threshold values

## Drawings

# Printed-circuit board connector - SMSTB 2,5/12-G - 1769337

Drilling diagram

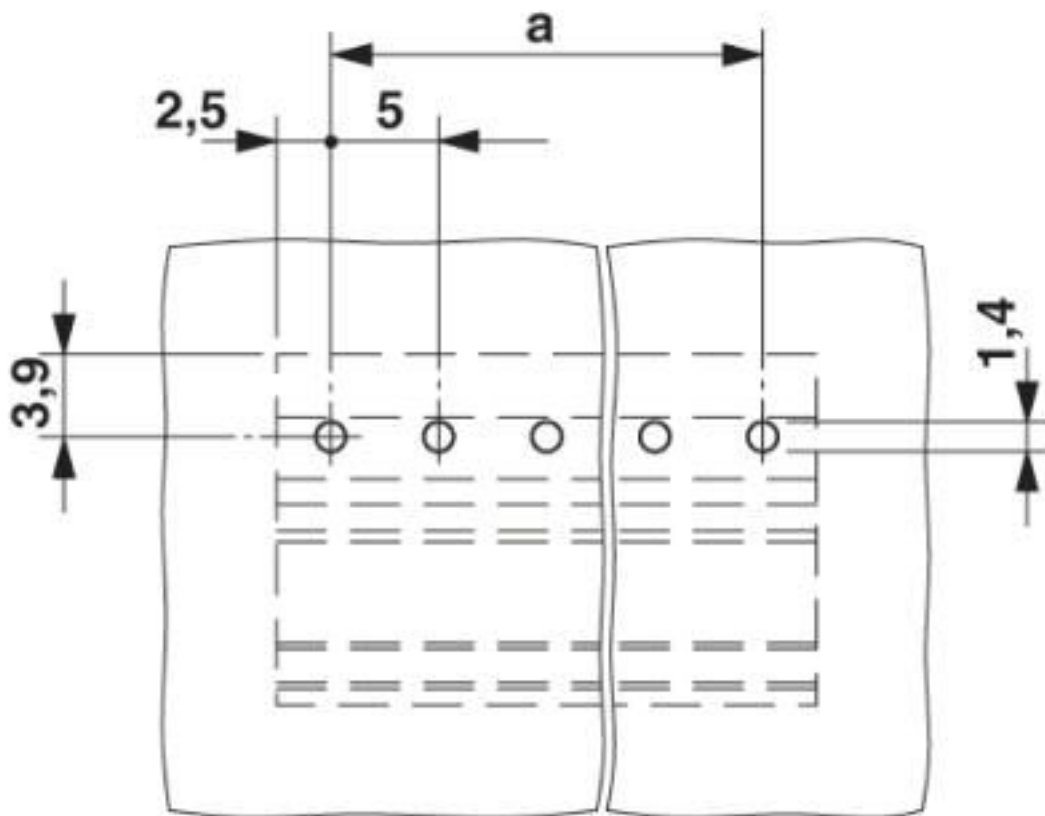

Diagram

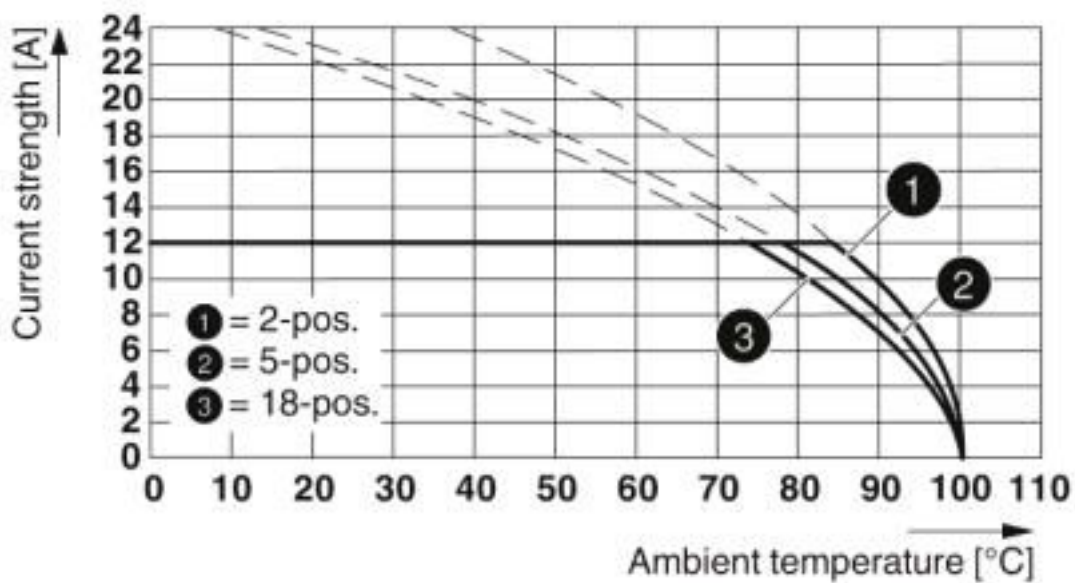

Type: FKC 2,5/...-ST with SMSTB 2,5/...-G

# Printed-circuit board connector - SMSTB 2,5/12-G - 1769337

Diagram

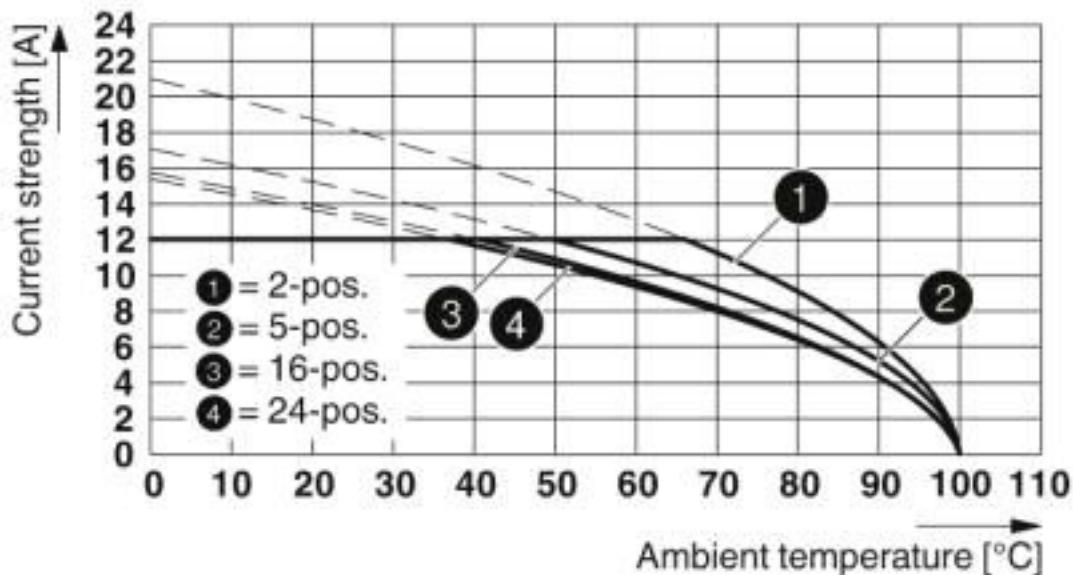

Type: MVSTB(R/W) 2,5/...-ST with SMSTB 2,5/...-G

Diagram

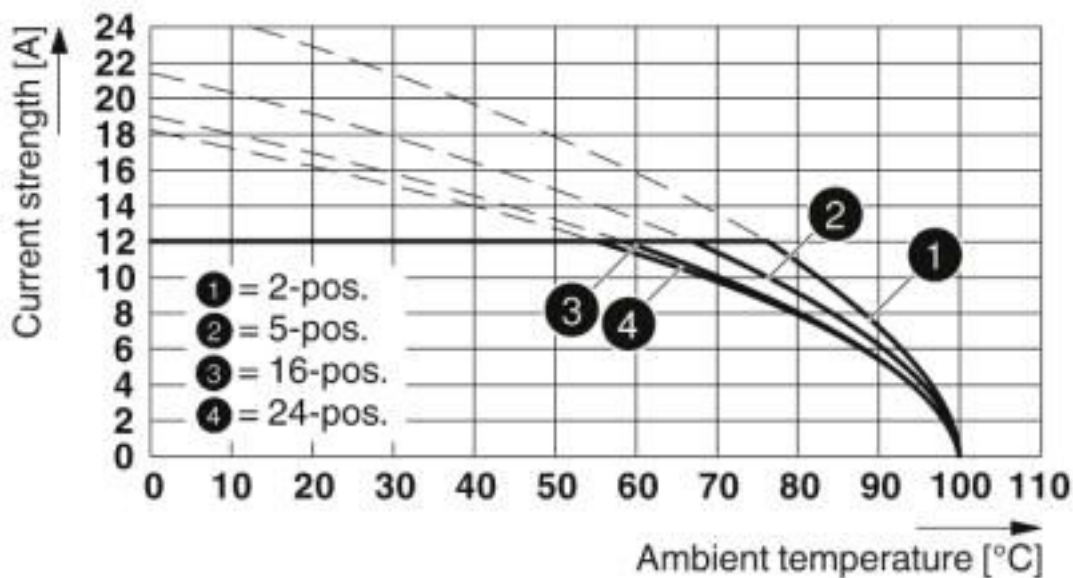

Type: FRONT-MSTB 2,5/...-ST with SMSTB 2,5/...-G

# Printed-circuit board connector - SMSTB 2,5/12-G - 1769337

Diagram

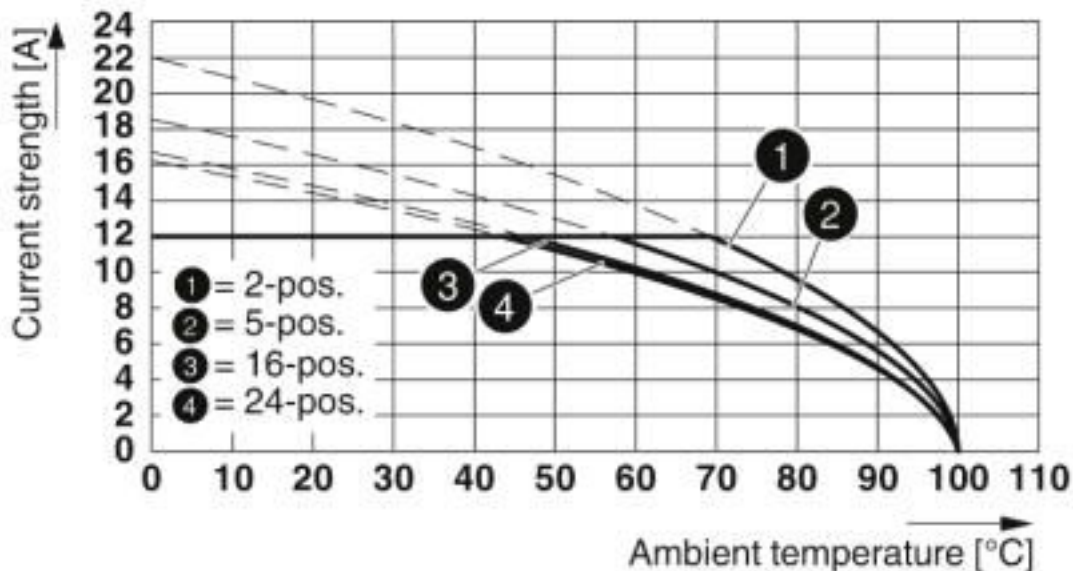

Type: SMSTB 2,5/...-ST with SMSTB 2,5/...-G

Diagram

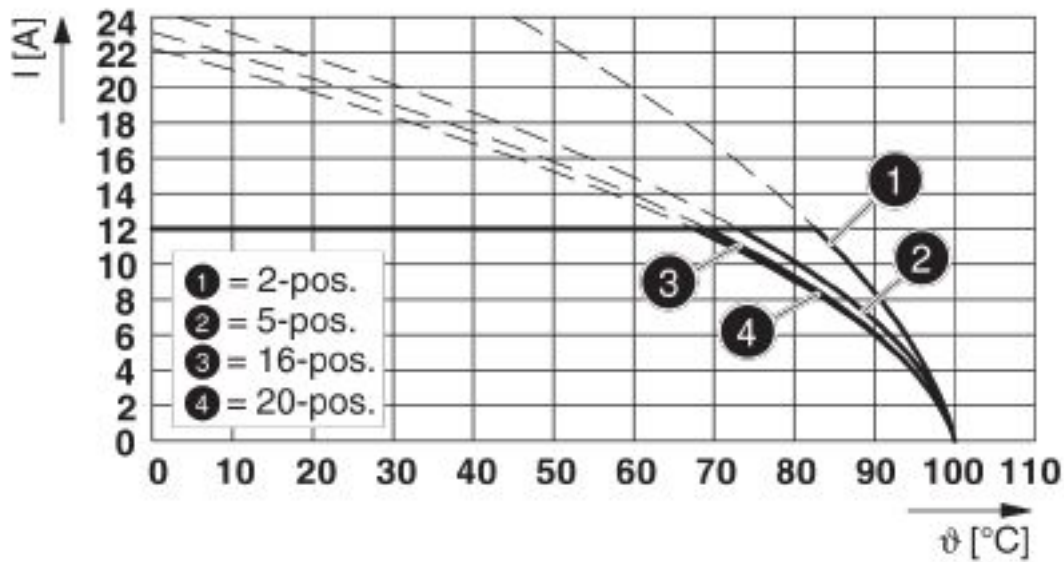

Type: FKCT 2,5/...-ST with SMSTB 2,5/...-G

# Printed-circuit board connector - SMSTB 2,5/12-G - 1769337

Diagram

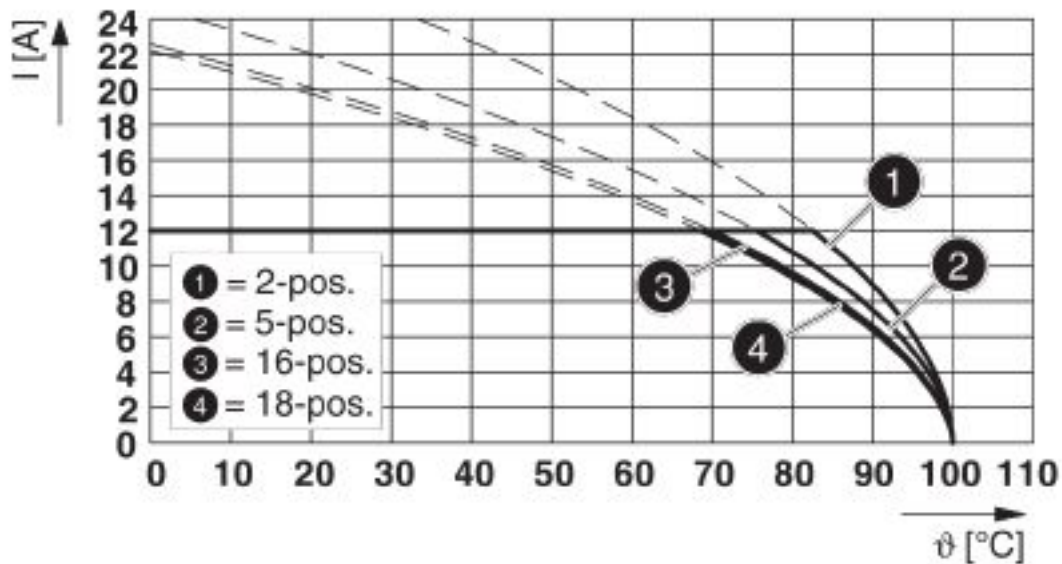

Type: FKCN 2,5/...-ST with SMSTB 2,5/...-G

Diagram

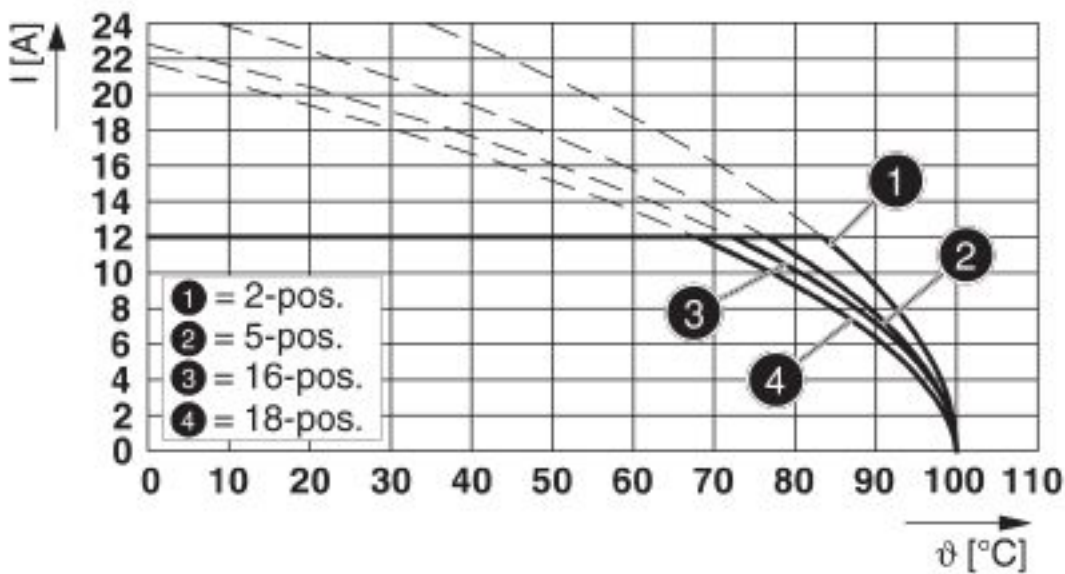

Type: FKCV(W/R) 2,5/...-ST with SMSTB 2,5/...-G



# Printed-circuit board connector - SMSTB 2,5/12-G - 1769337

Dimensional drawing

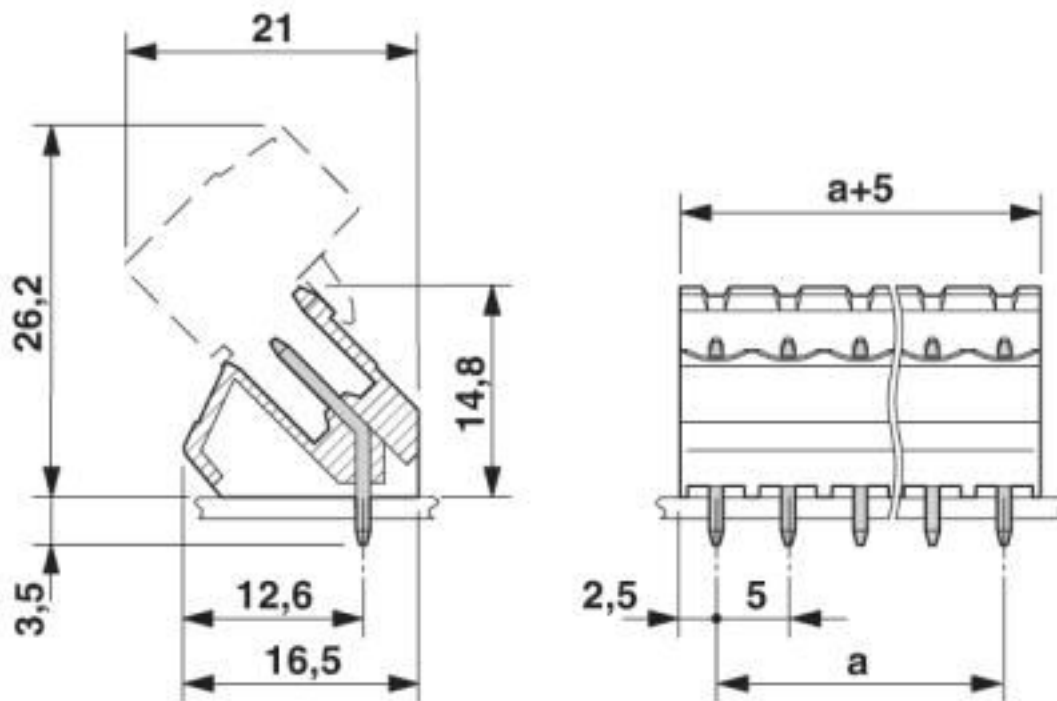

## Classifications

### eCl@ss

eCl@ss 10.0.1	27440402
eCl@ss 4.0	27260700
eCl@ss 4.1	27260700
eCl@ss 5.0	27260700
eCl@ss 5.1	27260700
eCl@ss 6.0	27260700
eCl@ss 7.0	27440402
eCl@ss 8.0	27440402
eCl@ss 9.0	27440402

### ETIM

ETIM 3.0	EC001121
ETIM 4.0	EC002637
ETIM 5.0	EC002637
ETIM 6.0	EC002637
ETIM 7.0	EC002637

### UNSPSC

UNSPSC 6.01	30211810
UNSPSC 7.0901	39121409

# Printed-circuit board connector - SMSTB 2,5/12-G - 1769337

## Classifications

### UNSPSC

UNSPSC 11	39121409
UNSPSC 12.01	39121409
UNSPSC 13.2	39121409
UNSPSC 18.0	39121409
UNSPSC 19.0	39121409
UNSPSC 20.0	39121409
UNSPSC 21.0	39121409

## Approvals

### Approvals

#### Approvals

CSA / IECCEB CB Scheme / EAC / cULus Recognized / VDE Zeichengenehmigung

#### Ex Approvals

### Approval details

CSA		<a href="http://www.csagroup.org/services-industries/product-listing/">http://www.csagroup.org/services-industries/product-listing/</a>	13631
		B	D
Nominal voltage UN		300 V	300 V
Nominal current IN		15 A	10 A

IECEE CB Scheme		<a href="http://www.iecee.org/">http://www.iecee.org/</a>	DE1-60988-B1B2
Nominal voltage UN		250 V	
Nominal current IN		12 A	

EAC		B.01687
-----	---	---------

# Printed-circuit board connector - SMSTB 2,5/12-G - 1769337

## Approvals

cULus Recognized		<a href="http://database.ul.com/cgi-bin/XYV/template/LISEXT/1FRAME/index.htm">http://database.ul.com/cgi-bin/XYV/template/LISEXT/1FRAME/index.htm</a>	E60425-19931011
	B	D	
Nominal voltage UN	300 V	300 V	
Nominal current IN	15 A	10 A	

VDE Zeichengenehmigung		<a href="http://www2.vde.com/de/Institut/Online-Service/VDE-gepruefteProdukte/Seiten/Online-Suche.aspx">http://www2.vde.com/de/Institut/Online-Service/VDE-gepruefteProdukte/Seiten/Online-Suche.aspx</a>	40050648
Nominal voltage UN	250 V		
Nominal current IN	12 A		

## Accessories

### Accessories

#### Coding element

Coding section - CR-MSTB - 1734401

Coding section, inserted into the recess in the header or the inverted plug, red insulating material



#### Filler plug

Accessories - MSTB-BL - 1755477



Keying cap, for forming sections, plugs onto header pin, green insulating material

#### Labeled terminal marker

Marker card - SK 5/3,8:FORTL.ZAHLEN - 0804183



Marker card, Card, white, labeled, horizontal: consecutive numbers 1 ... 10, 11 ... 20, etc. up to 91 ... (99)100, mounting type: adhesive, for terminal block width: 5 mm, lettering field size: 5 x 3.8 mm

## Printed-circuit board connector - SMSTB 2,5/12-G - 1769337

### Accessories

---

#### Additional products

Plug - QC 1,5/12-ST - 1718067

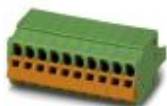

PCB connector, nominal current: 12 A, rated voltage (III/2): 630 V, nominal cross section: 1.5 mm<sup>2</sup>, number of positions: 12, pitch: 5 mm, connection method: Displacement connection, color: green, contact surface: Tin

---

Printed-circuit board connector - FKCN 2,5/12-ST - 1732836



PCB connector, nominal current: 12 A, rated voltage (III/2): 320 V, nominal cross section: 2.5 mm<sup>2</sup>, number of positions: 12, pitch: 5 mm, connection method: Push-in spring connection, color: green, contact surface: Tin

---

Printed-circuit board connector - MSTB 2,5/12-ST - 1754643



PCB connector, nominal current: 12 A, rated voltage (III/2): 320 V, nominal cross section: 2.5 mm<sup>2</sup>, number of positions: 12, pitch: 5 mm, connection method: Screw connection with tension sleeve, color: green, contact surface: Tin

---

Printed-circuit board connector - MSTB 2,5/12-STZ - 1759350



PCB connector, nominal current: 12 A, rated voltage (III/2): 320 V, nominal cross section: 2.5 mm<sup>2</sup>, number of positions: 12, pitch: 5 mm, connection method: Screw connection with tension sleeve, color: green, contact surface: Tin

---

Printed-circuit board connector - MSTBP 2,5/12-ST - 1765878



PCB connector, nominal current: 12 A, rated voltage (III/2): 320 V, nominal cross section: 2.5 mm<sup>2</sup>, number of positions: 12, pitch: 5 mm, connection method: Screw connection with tension sleeve, color: green, contact surface: Tin

---

## Printed-circuit board connector - SMSTB 2,5/12-G - 1769337

### Accessories

#### Printed-circuit board connector - SMSTB 2,5/12-ST - 1768859



PCB connector, nominal current: 12 A, rated voltage (III/2): 320 V, nominal cross section: 2.5 mm<sup>2</sup>, number of positions: 12, pitch: 5 mm, connection method: Screw connection with tension sleeve, color: green, contact surface: Tin

#### Printed-circuit board connector - FRONT-MSTB 2,5/12-ST - 1779518



PCB connector, nominal current: 12 A, rated voltage (III/2): 320 V, nominal cross section: 2.5 mm<sup>2</sup>, number of positions: 12, pitch: 5 mm, connection method: Front screw connection, color: green, contact surface: Tin

#### Printed-circuit board connector - MSTBT 2,5/12-ST - 1779932



PCB connector, nominal current: 12 A, rated voltage (III/2): 320 V, nominal cross section: 2.5 mm<sup>2</sup>, number of positions: 12, pitch: 5 mm, connection method: Screw connection with tension sleeve, color: green, contact surface: Tin

#### Printed-circuit board connector - MVSTBR 2,5/12-ST - 1792113



PCB connector, nominal current: 12 A, rated voltage (III/2): 320 V, nominal cross section: 2.5 mm<sup>2</sup>, number of positions: 12, pitch: 5 mm, connection method: Screw connection with tension sleeve, color: green, contact surface: Tin

#### Printed-circuit board connector - MVSTBW 2,5/12-ST - 1792621



PCB connector, nominal current: 12 A, rated voltage (III/2): 320 V, nominal cross section: 2.5 mm<sup>2</sup>, number of positions: 12, pitch: 5 mm, connection method: Screw connection with tension sleeve, color: green, contact surface: Tin

## Printed-circuit board connector - SMSTB 2,5/12-G - 1769337

### Accessories

#### Printed-circuit board connector - FKCT 2,5/12-ST - 1909317



PCB connector, nominal current: 12 A, rated voltage (III/2): 320 V, nominal cross section: 2.5 mm<sup>2</sup>, number of positions: 12, pitch: 5 mm, connection method: Push-in spring connection, color: green, contact surface: Tin

#### Printed-circuit board connector - FKCVR 2,5/12-ST - 1909812



PCB connector, nominal current: 12 A, rated voltage (III/2): 320 V, nominal cross section: 2.5 mm<sup>2</sup>, number of positions: 12, pitch: 5 mm, connection method: Push-in spring connection, color: green, contact surface: Tin

#### Printed-circuit board connector - FKCVW 2,5/12-ST - 1910131



PCB connector, nominal current: 12 A, rated voltage (III/2): 320 V, nominal cross section: 2.5 mm<sup>2</sup>, number of positions: 12, pitch: 5 mm, connection method: Push-in spring connection, color: green, contact surface: Tin

#### Printed-circuit board connector - FKC 2,5/12-ST - 1910458



PCB connector, nominal current: 12 A, rated voltage (III/2): 320 V, nominal cross section: 2.5 mm<sup>2</sup>, number of positions: 12, pitch: 5 mm, connection method: Push-in spring connection, color: green, contact surface: Tin

#### Printed-circuit board connector - FKCS 2,5/12-ST - 1974834



PCB connector, nominal current: 12 A, rated voltage (III/2): 320 V, nominal cross section: 2.5 mm<sup>2</sup>, number of positions: 12, pitch: 5 mm, connection method: Push-in spring connection, color: green, contact surface: Tin

Phoenix Contact 2020 © - all rights reserved  
<http://www.phoenixcontact.com>

PHOENIX CONTACT GmbH & Co. KG  
Flachsmarktstr. 8  
32825 Blomberg  
Germany  
Tel. +49 5235 300  
Fax +49 5235 3 41200  
<http://www.phoenixcontact.com>

## X-ON Electronics

Largest Supplier of Electrical and Electronic Components

*Click to view similar products for [Pluggable Terminal Blocks](#) category:*

*Click to view products by [Phoenix Contact](#) manufacturer:*

Other Similar products are found below :

[57.510.0053](#) [MC 1.5/ 6-ST-3.5 GY AU](#) [ET02015000J0G](#) [734-104](#) [734-302](#) [8-141-P](#) [8426620000](#) [860505](#) [860516](#) [860810](#) [GBPACX-12](#)  
[93.731.4953.0](#) [PV05-5,08-K](#) [PVP02-5,00](#) [PVP03-3,50](#) [PVP04-3,50](#) [PVS02-5,00](#) [1-1986160-3](#) [1377680000](#) [1531000000](#) [1546228-5](#)  
[ELFH16150](#) [ELFP03110](#) [ELFP10210](#) [ELFT06250](#) [ELVP03100](#) [1700101](#) [1700410](#) [1700425](#) [1702246](#) [1705229](#) [1710175](#) [1714537](#) [1717806](#)  
[1719600](#) [1728941](#) [1734692](#) [1734795](#) [1736036](#) [1740194](#) [1740291](#) [1740628](#) [1740990](#) [1746952](#) [1750207](#) [1752441](#) [1752865](#) [1754115](#)  
[1754144](#) [1756913](#)