

PCB terminal block - PLH 16/ 2-10 - 1770393

Please be informed that the data shown in this PDF Document is generated from our Online Catalog. Please find the complete data in the user's documentation. Our General Terms of Use for Downloads are valid (<http://phoenixcontact.com/download>)



PCB terminal block, nominal current: 76 A, rated voltage (III/2): 400 V, nominal cross section: 16 mm², pitch: 10 mm, number of positions: 2, connection method: Push-lock spring connection, mounting: Wave soldering, conductor/PCB connection direction: 0 °, color: green, Pin layout: Linear double pinning, Solder pin [P]: 4.5 mm

The figure shows a 5-pos. version of the product

Your advantages

- Tool-free lever principle enables time-saving connection and release of conductors with/without ferrules
- Defined contact force ensures that contact remains stable over the long term
- Time-saving push-in connection when lever is closed
- Quick and convenient testing using integrated test option



Key Commercial Data

Packing unit	25 pc
GTIN	 4 046356 458276
GTIN	4046356458276

Technical data

Item properties

Brief article description	PCB terminal block
Range of articles	PLH 16/
Pitch	10 mm
Number of positions	2
Connection method	Push-lock spring connection
Mounting type	Wave soldering
Pin layout	Linear double pinning
Number of levels	1
Number of connections	2
Number of potentials	2

Electrical parameters

PCB terminal block - PLH 16/ 2-10 - 1770393

Technical data

Electrical parameters

Nominal current	76 A
Nom. voltage	400 V
Rated voltage	400 V
Rated voltage (III/2)	400 V
Rated voltage (II/2)	800 V
Rated surge voltage (III/3)	4 kV
Rated surge voltage (III/2)	4 kV
Rated surge voltage (II/2)	4 kV

Connection capacity

Connection method	Push-lock spring connection
Conductor cross section solid	0.75 mm ² ... 16 mm ²
Conductor cross section flexible	0.75 mm ² ... 25 mm ²
Conductor cross section AWG / kcmil	18 ... 4
Conductor cross section flexible, with ferrule without plastic sleeve	0.75 mm ² ... 16 mm ²
Conductor cross section, flexible, with ferrule, with plastic sleeve	0.75 mm ² ... 10 mm ²
2 conductors with the same cross section, flexible, with TWIN ferrule with plastic sleeve	0.75 mm ² ... 4 mm ²
Stripping length	18 mm

Material data - contact

Note	WEEE/RoHS-compliant, free of whiskers according to IEC 60068-2-82/ JEDEC JESD 201
Contact material	Cu alloy
Surface characteristics	Tin-plated
Metal surface terminal point (top layer)	Tin (10 - 16 µm Sn)
Metal surface soldering area (top layer)	Tin (10 - 16 µm Sn)

Material data - housing

Housing color	green (6021)
Insulating material	PA
Insulating material group	I
CTI according to IEC 60112	600
Flammability rating according to UL 94	V0
Glow wire flammability index GWFI according to EN 60695-2-12	850
Glow wire ignition temperature GWIT according to EN 60695-2-13	775
Temperature for the ball pressure test according to EN 60695-10-2	125 °C

Dimensions for the product

Length [l]	30.5 mm
Width [w]	21.4 mm
Height [h]	33.5 mm
Pitch	10 mm
Height (without solder pin)	29 mm

PCB terminal block - PLH 16/ 2-10 - 1770393

Technical data

Dimensions for the product

Solder pin [P]	4.5 mm
Pin spacing	12.5 mm
Pin dimensions	1.2 x 1.2 mm

Dimensions for PCB design

Hole diameter	1.6 mm
Pin spacing	12.5 mm

Packaging information

Type of packaging	packed in cardboard
Pieces per package	25
Denomination packing units	Pcs.

Ambient conditions

Ambient temperature (storage/transport)	-40 °C ... 70 °C
Ambient temperature (assembly)	-5 °C ... 100 °C
Ambient temperature (operation)	-40 °C ... 100 °C (Depending on the current carrying capacity/derating curve)

Termination and connection method

Test result	Test passed
Test – repeated connection and release	IEC 60999-1:1999-11
	Test passed
Test for conductor damage and slackening	IEC 60999-1:1999-11
	Test passed

Pull-out test

Pull-out test	IEC 60999-1:1999-11
	Test passed
Conductor cross section / conductor type / tensile force	0.75 mm ² / solid / > 30 N
	0.75 mm ² / flexible / > 30 N
	16 mm ² / stranded / > 100 N
	16 mm ² / flexible / > 100 N
	10 mm ² / flexible with ferrule / > 90 N

Mechanical tests according to standard

Test specification	IEC 60947-7-4
--------------------	---------------

Electrical tests

Rated current	76 A
Conductor cross section	25 mm ²
Rated voltage (III/2)	400 V
Rated surge voltage (III/2)	4 kV

Air clearances and creepage distances

Clearances and creepage distances	IEC 60664-1:2007-04
-----------------------------------	---------------------

PCB terminal block - PLH 16/ 2-10 - 1770393

Technical data

Air clearances and creepage distances

Specification	IEC 60664-1:2007-04
Minimum clearance - inhomogeneous field (III/3)	3 mm
Minimum clearance - inhomogeneous field (III/2)	3 mm
Minimum clearance - inhomogeneous field (II/2)	3 mm
Minimum creepage distance value (III/3)	5 mm
Minimum creepage distance value (III/2)	3 mm
Minimum creepage distance value (II/2)	4 mm

Temperature-rise test

Specification	IEC 60947-7-4:2013-08
Result	Test passed
Requirement temperature-rise test	The sum of ambient temperature and temperature rise of the PCB terminal block shall not exceed the upper limiting temperature.

Current carrying capacity / derating curves

Caption	Type: PLH 16/...-10 Tested according to DIN EN 60512-5-2:2003-01 Number of positions: 4 Conductor cross section: 16 mm ²
Specification	IEC 60947-7-4:2013-08
Number of positions	4
Reduction factor	1
Note	Representation based on IEC 60512-5-2:2002-02

Vibration test

Specification	IEC 60068-2-6:2007-12
Result	Test passed
Frequency	10 - 150 - 10 Hz
Sweep speed	1 octave/min
Amplitude	0.35 mm (10 - 60.1 Hz)
Acceleration	5 g (60.1 - 150 Hz)
Test duration per axis	2.5 h

Insulation resistance

Specification	IEC 60512-3-1:2002-02
Result	Test passed
Insulation resistance, neighboring positions	> 1 TΩ

Glow-wire test

Specification	IEC 60695-2-10:2000-10
Result	Test passed
Temperature	850 °C
Time of exposure	5 s

Alternating climate test

PCB terminal block - PLH 16/ 2-10 - 1770393

Technical data

Alternating climate test

Result	Test passed
Specification	ISO 6988:1985-02
Corrosive stress	KFW 0.2 S/1 cycle

Standards and Regulations

Connection in acc. with standard	UL
Flammability rating according to UL 94	V0

Environmental Product Compliance

China RoHS	Environmentally friendly use period: unlimited = EFUP-e
	No hazardous substances above threshold values

Drawings

PCB terminal block - PLH 16/ 2-10 - 1770393

Functional drawing

2

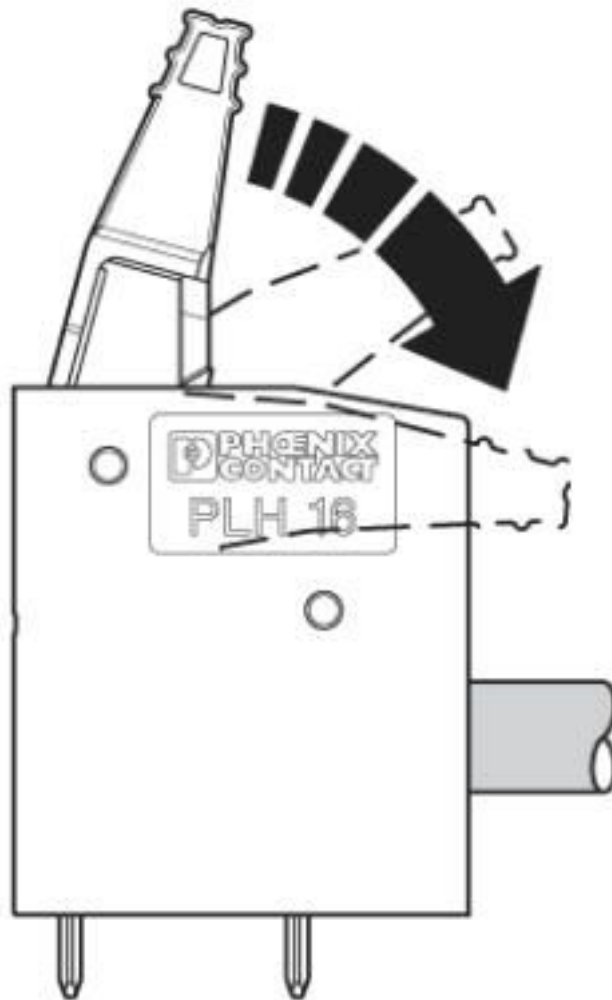

PCB terminal block - PLH 16/ 2-10 - 1770393

Drilling diagram

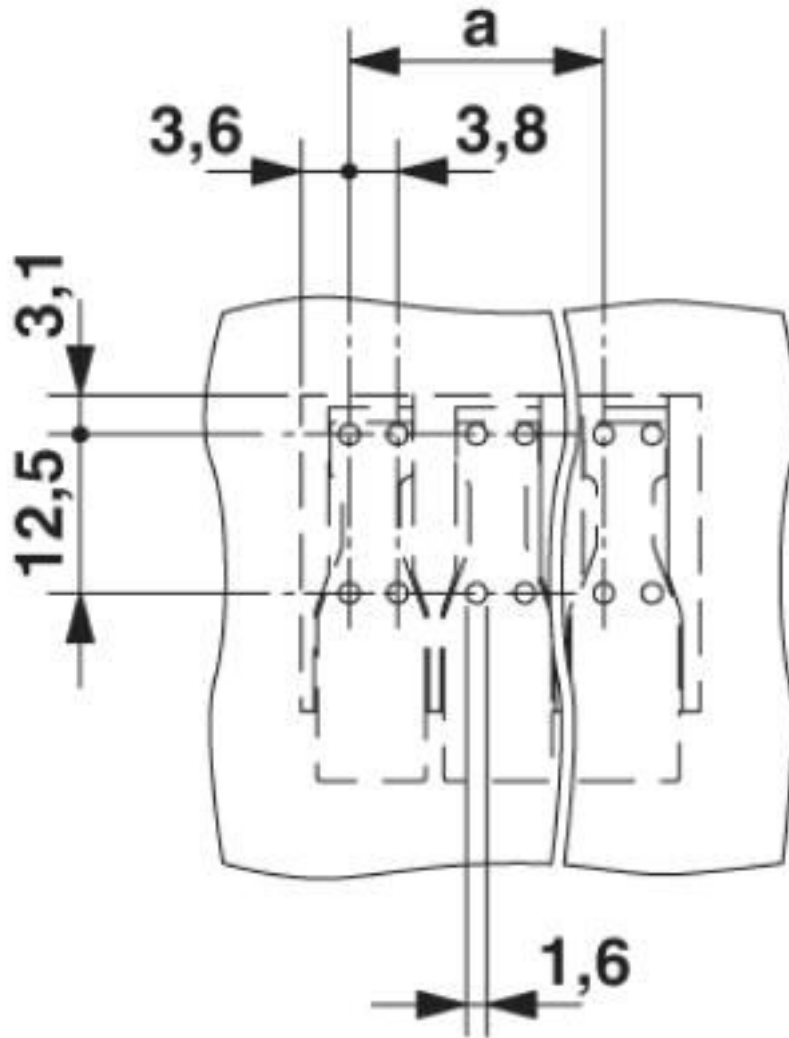

PCB terminal block - PLH 16/ 2-10 - 1770393

Functional drawing

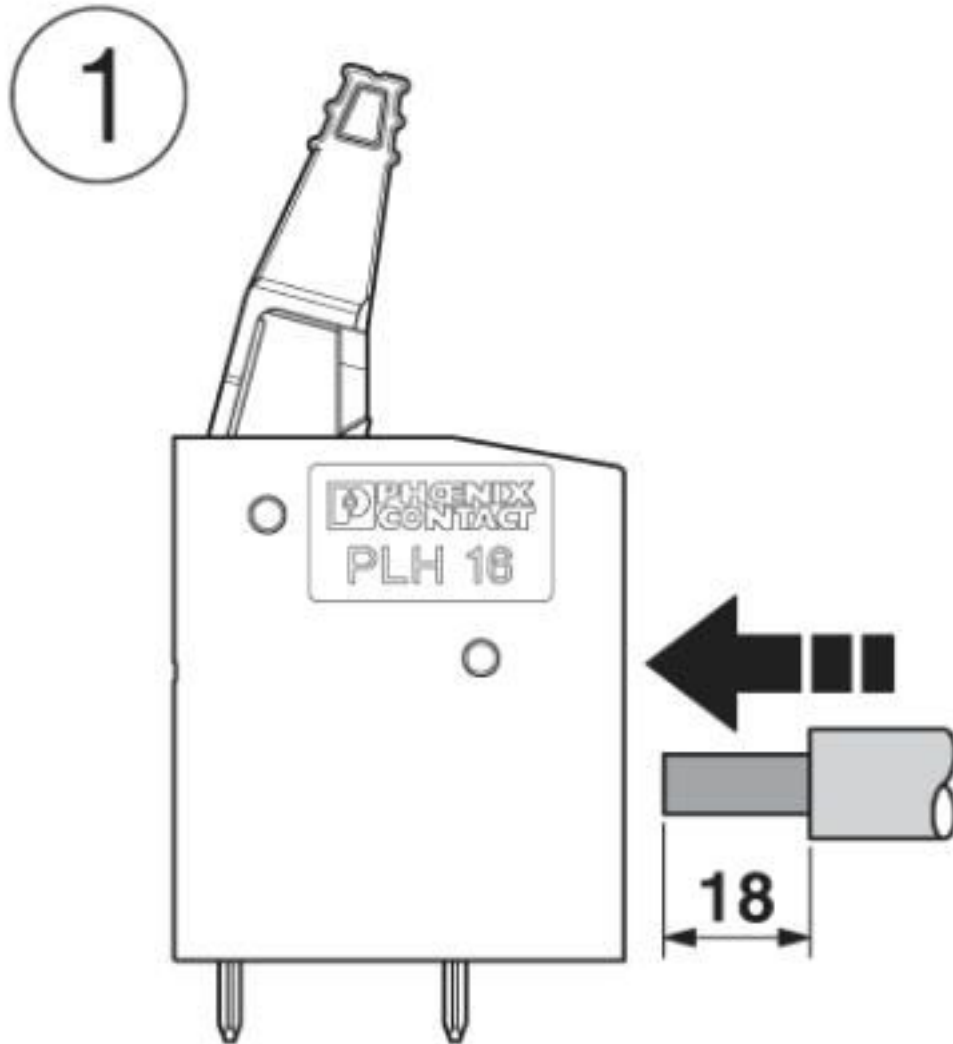

PCB terminal block - PLH 16/ 2-10 - 1770393

Diagram

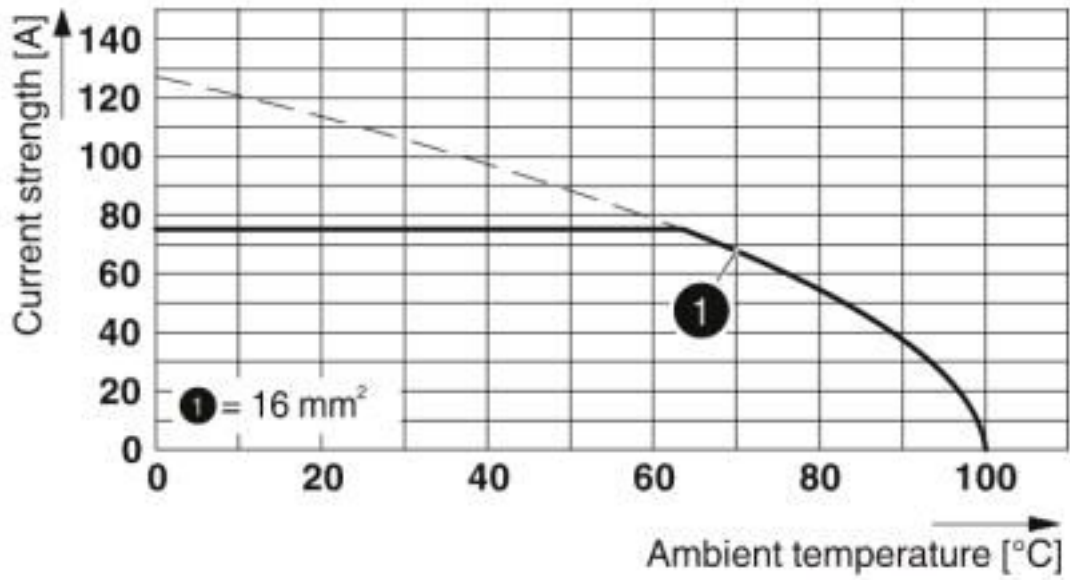

Type: PLH 16/...-10
Tested according to DIN EN 60512-5-2:2003-01
Number of positions: 4
Conductor cross section: 16 mm²

PCB terminal block - PLH 16/ 2-10 - 1770393

Functional drawing

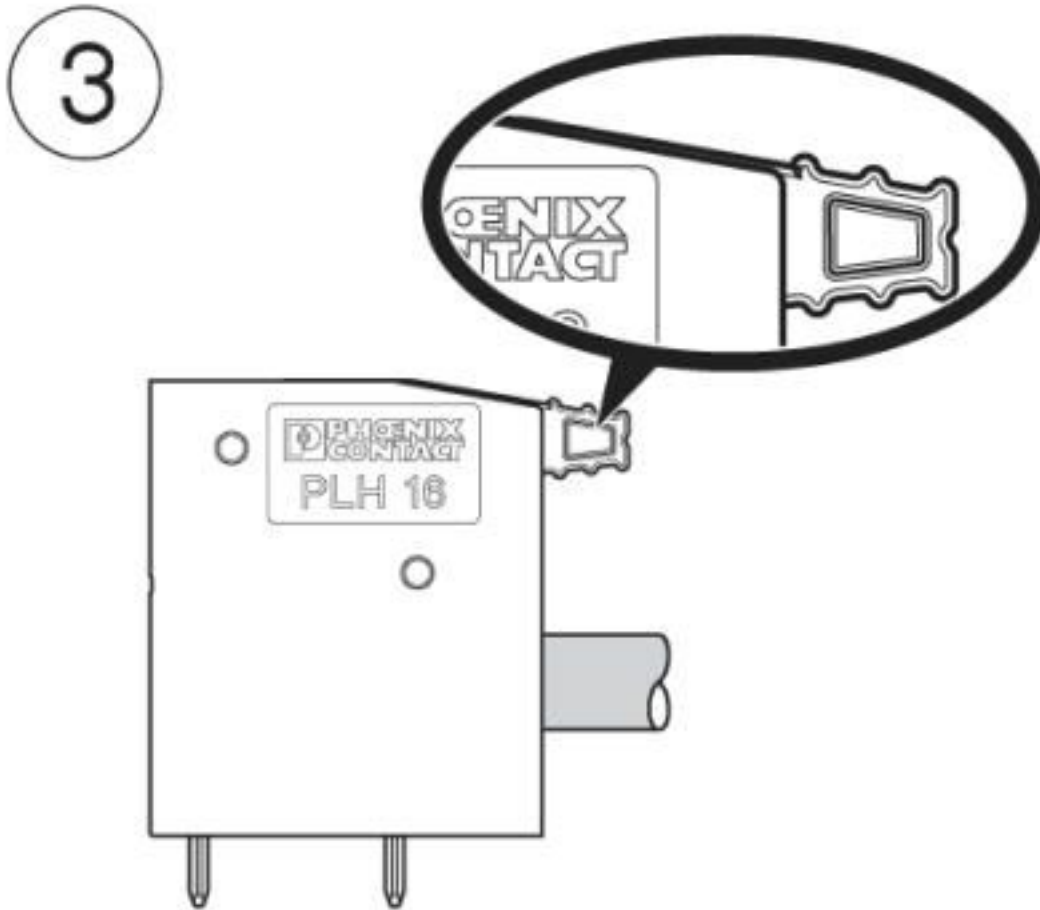

PCB terminal block - PLH 16/ 2-10 - 1770393

Functional drawing



PCB terminal block - PLH 16/ 2-10 - 1770393

Dimensional drawing

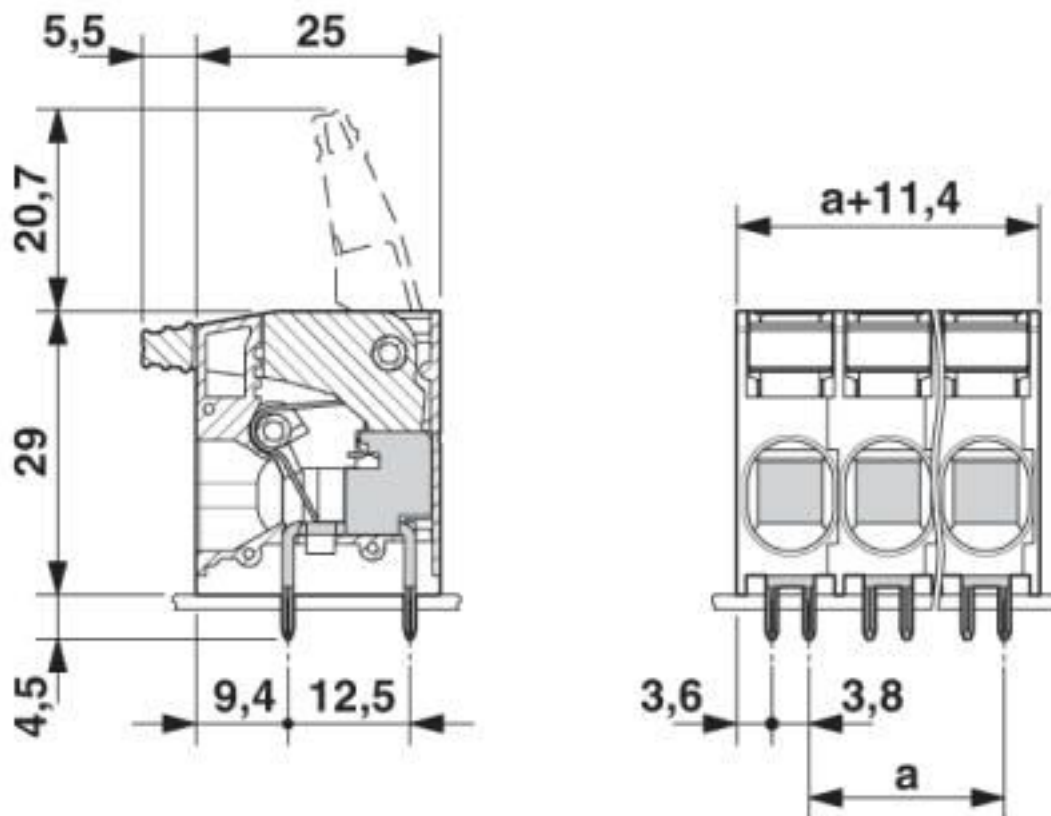

Classifications

eCl@ss

eCl@ss 10.0.1	27440401
eCl@ss 4.0	27141100
eCl@ss 4.1	27141100
eCl@ss 5.0	27141100
eCl@ss 5.1	27261100
eCl@ss 6.0	27261100
eCl@ss 7.0	27440401
eCl@ss 8.0	27440401
eCl@ss 9.0	27440401

ETIM

ETIM 3.0	EC001121
ETIM 4.0	EC002643
ETIM 5.0	EC002643
ETIM 6.0	EC002643
ETIM 7.0	EC002643

PCB terminal block - PLH 16/ 2-10 - 1770393

Classifications

UNSPSC

UNSPSC 6.01	30211801
UNSPSC 7.0901	39121432
UNSPSC 11	39121432
UNSPSC 12.01	39121432
UNSPSC 13.2	39121432
UNSPSC 18.0	39121432
UNSPSC 19.0	39121432
UNSPSC 20.0	39121432
UNSPSC 21.0	39121432

Approvals

Approvals

Approvals

UL Recognized / IECCEB Scheme / VDE Zeichengenehmigung / EAC

Ex Approvals

Approval details

UL Recognized		http://database.ul.com/cgi-bin/XYV/template/LISEXT/1FRAME/index.htm E60425-20110524	
	B	C	D
Nominal voltage UN	300 V	150 V	300 V
Nominal current IN	51 A	51 A	10 A
mm ² /AWG/kcmil	18-6	18-6	18-6

IECEE CB Scheme		http://www.iecee.org/	DE1-58718
Nominal voltage UN	400 V		
Nominal current IN	76 A		
mm ² /AWG/kcmil	0.75-16		

PCB terminal block - PLH 16/ 2-10 - 1770393

Approvals

VDE Zeichengenehmigung		http://www2.vde.com/de/Institut/Online-Service/VDE-gepruefteProdukte/Seiten/Online-Suche.aspx	40041250
Nominal voltage UN	400 V		
Nominal current IN	76 A		
mm ² /AWG/kcmil	0.75-16		

EAC		B.01687
-----	--	---------

Accessories

Accessories

Crimping tool

Crimping pliers - CRIMPFOX 6 - 1212034



Crimping pliers, for ferrules without insulating collar according to DIN 46228 Part 1 and ferrules with insulating collar according to DIN 46228 Part 4, 0.25 mm² ... 6.0 mm², lateral entry, trapezoidal crimp

Crimping pliers - CRIMPFOX 16 S - 1207983



Crimping pliers for ferrules up to 16 mm²

Terminal marking

Marker card - SK U/3,8 WH:UNBEDRUCKT - 0803906



Marker card, Sheet, white, unlabeled, can be labeled with: PLOTMARK, CMS-P1-PLOTTER, Office printing systems, mounting type: adhesive, for terminal block width: 210 mm, lettering field size: 186 x 3.8 mm, Number of individual labels: 1440

Phoenix Contact 2020 © - all rights reserved
<http://www.phoenixcontact.com>

PHOENIX CONTACT GmbH & Co. KG
Flachsmarktstr. 8
32825 Blomberg
Germany
Tel. +49 5235 300
Fax +49 5235 3 41200
<http://www.phoenixcontact.com>

X-ON Electronics

Largest Supplier of Electrical and Electronic Components

Click to view similar products for [Fixed Terminal Blocks](#) category:

Click to view products by [Phoenix Contact](#) manufacturer:

Other Similar products are found below :

[MBE-1512](#) [MBE-154](#) [MBE-156](#) [MBES-153](#) [MBES-156](#) [MH-2512](#) [MHE-132](#) [MHE-163](#) [MI-254 \(35\)](#) [MI-272](#) [880507](#) [MPT-275](#)
[15602-04-08-21](#) [BA311TU](#) [BA411SU](#) [MV-152](#) [MV-252-D](#) [MV-253/NCNOC](#) [MV-254-D](#) [MV-255](#) [MV-462](#) [MV-493](#) [MVE-252](#) [MVE-253](#)
[MVE-273](#) [MVEB-153](#) [1700096](#) [1705142](#) [1712417](#) [1713020](#) [1713088](#) [1745195](#) [1760594](#) [1776118-2](#) [1790852](#) [1-796689-8](#) [1-796692-6](#)
[1800001](#) [1800114](#) [1995279](#) [20020314-C121B01LF](#) [CB2-12](#) [KP03215000J0G](#) [KP04215000J0G](#) [S451](#) [282802-2](#) [29.007](#) [29.116](#) [30.103](#)
[30.106](#)