

Printed-circuit board connector - FRONT-MSTB 2,5/21-ST-5,08 - 1777471

Please be informed that the data shown in this PDF Document is generated from our Online Catalog. Please find the complete data in the user's documentation. Our General Terms of Use for Downloads are valid (<http://phoenixcontact.com/download>)

PCB connector, nominal current: 12 A, rated voltage (III/2): 320 V, nominal cross section: 2.5 mm², number of positions: 21, pitch: 5.08 mm, connection method: Front screw connection, color: green, contact surface: Tin



The figure shows a 10-position version of the product

Your advantages

- ✓ Well-known connection principle allows worldwide use
- ✓ Optimized for tight installation situations: operation and conductor connection from one direction
- ✓ Low temperature rise, thanks to maximum contact force
- ✓ Allows connection of two conductors



Key Commercial Data

Packing unit	50 pc
GTIN	 4 017918 039622
GTIN	4017918039622

Technical data

Item properties

Brief article description	Printed-circuit board connector
Plug-in system	CLASSIC COMBICON
Type of contact	Female connector
Range of articles	FRONT-MSTB 2,5/...-ST
Pitch	5.08 mm
Number of positions	21
Connection method	Front screw connection
Drive form screw head	Slotted (L)
Screw thread	M2,5
Locking	without

Printed-circuit board connector - FRONT-MSTB 2,5/21-ST-5,08 - 1777471

Technical data

Item properties

Number of levels	1
Number of connections	21
Number of potentials	21

Electrical parameters

Nominal current	12 A
Nom. voltage	320 V
Rated voltage	250 V
Rated voltage (III/2)	320 V
Rated voltage (II/2)	630 V
Rated surge voltage (III/3)	4 kV
Rated surge voltage (III/2)	4 kV
Rated surge voltage (II/2)	4 kV

Connection capacity

Connection method	Front screw connection
pluggable	Yes
Conductor cross section solid	0.34 mm ² ... 2.5 mm ²
Conductor cross section flexible	0.2 mm ² ... 2.5 mm ²
Conductor cross section AWG / kcmil	24 ... 12
Conductor cross section flexible, with ferrule without plastic sleeve	0.25 mm ² ... 2.5 mm ²
Conductor cross section, flexible, with ferrule, with plastic sleeve	0.25 mm ² ... 2.5 mm ²
2 conductors with same cross section, solid	0.2 mm ² ... 1 mm ²
2 conductors with same cross section, flexible	0.2 mm ² ... 1.5 mm ²
2 conductors with same cross section, flexible, with ferrule without plastic sleeve	0.25 mm ² ... 1 mm ²
2 conductors with the same cross section, flexible, with TWIN ferrule with plastic sleeve	0.5 mm ² ... 1.5 mm ²
Cylindrical gauge a x b / diameter	2.8 mm x 2.0 mm / 2.4 mm
Stripping length	10 mm
Torque	0.5 Nm ... 0.6 Nm

Material data - contact

Note	WEEE/RoHS-compliant, free of whiskers according to IEC 60068-2-82/ JEDEC JESD 201
Contact material	Cu alloy
Surface characteristics	hot-dip tin-plated
Metal surface terminal point (top layer)	Tin (4 - 8 µm Sn)
Metal surface contact area (top layer)	Tin (4 - 8 µm Sn)

Material data - housing

Housing color	green (6021)
Insulating material	PA

Printed-circuit board connector - FRONT-MSTB 2,5/21-ST-5,08 - 1777471

Technical data

Material data - housing

Insulating material group	I
CTI according to IEC 60112	600
Flammability rating according to UL 94	V0
Glow wire flammability index GWFI according to EN 60695-2-12	850
Glow wire ignition temperature GWIT according to EN 60695-2-13	775
Temperature for the ball pressure test according to EN 60695-10-2	125 °C

Dimensions for the product

Length [l]	27.2 mm
Width [w]	106.68 mm
Height [h]	14.9 mm
Pitch	5.08 mm
Height (without solder pin)	14.9 mm

Packaging information

Type of packaging	packed in cardboard
Pieces per package	50
Denomination packing units	Pcs.

General product information

Note	In accordance with IEC 61984, COMBICON connectors have no switching power (COC). During designated use, they must not be plugged in or disconnected when carrying voltage or under load.
------	--

Ambient conditions

Ambient temperature (storage/transport)	-40 °C ... 70 °C
Ambient temperature (assembly)	-5 °C ... 100 °C
Ambient temperature (operation)	-40 °C ... 100 °C (dependent on the derating curve)

Termination and connection method

Test for conductor damage and slackening	IEC 60999-1:1999-11
	Test passed

Pull-out test

Pull-out test	IEC 60999-1:1999-11
	Test passed
Conductor cross section / conductor type / tensile force	0.34 mm ² / solid / > 15 N
	0.2 mm ² / flexible / > 10 N
	2.5 mm ² / solid / > 50 N
	2.5 mm ² / flexible / > 50 N

Mechanical tests according to standard

Test specification	IEC 61984
Visual inspection	IEC 60512-1-1:2002-02

Printed-circuit board connector - FRONT-MSTB 2,5/21-ST-5,08 - 1777471

Technical data

Mechanical tests according to standard

Dimension check	IEC 60512-1-2:2002-02
Resistance of inscriptions	IEC 60068-2-70:1995-12
Insertion and withdrawal force	IEC 60512-13-2:2006-02
No. of cycles	25
Insertion strength per pos. approx.	8 N
Withdraw strength per pos. approx.	6 N
Polarization and coding	IEC 60512-13-5:2006-02
Contact holder in insert	IEC 60512-15-1:2008-05
Test force per pos.	35 N

Air clearances and creepage distances

Clearances and creepage distances	IEC 60664-1:2007-04
Specification	IEC 60664-1:2007-04
Minimum clearance - inhomogeneous field (III/3)	3 mm
Minimum clearance - inhomogeneous field (III/2)	3 mm
Minimum clearance - inhomogeneous field (II/2)	3 mm
Minimum creepage distance value (III/3)	3.2 mm
Minimum creepage distance value (III/2)	3 mm
Minimum creepage distance value (II/2)	3.2 mm

Current carrying capacity / derating curves

Caption	Type: FRONT-MSTB 2,5/...-ST-5,08 with CC 2,5/...-G-5,08 P26THR
Specification	IEC 61984:2008-10
Reduction factor	0.8
Note	Representation based on IEC 60512-5-2:2002-02
	For number of positions, see diagram

Mechanical tests (A)

Test specification	IEC 61984
Insertion strength per pos. approx.	8 N
Withdraw strength per pos. approx.	6 N
Polarization when inserted requirement >20 N	Test passed
Contact holder in insert requirements >20 N	Test passed

Durability tests (B)

Specification	IEC 60512-9-1:2010-03
Contact resistance R ₁	1.5 mΩ
Insertion/withdrawal cycles	25
Contact resistance R ₂	1.5 mΩ
Impulse withstand voltage at sea level	4.8 kV
Power-frequency withstand voltage	2.21 kV

Printed-circuit board connector - FRONT-MSTB 2,5/21-ST-5,08 - 1777471

Technical data

Durability tests (B)

Insulation resistance, neighboring positions	> 0.2 TΩ
--	----------

Thermal tests (C)

Specification	IEC 60512-5-1:2002-02
Number of positions	12
Conductor cross section	2.5 mm ²
Test current	12 A
Upper limiting temperature requirements <100 °C	Test passed

Climatic tests (D)

Specification	ISO 6988:1985-02
Cold stress	-40 °C/2 h
Thermal stress	100 °C/168 h
Corrosive stress	0.2 dm ³ SO ₂ on 300 dm ³ /40 °C/1 cycle
Impulse withstand voltage at sea level	4.8 kV
Power-frequency withstand voltage	2.21 kV

Environmental and durability tests (E)

Specification	IEC 61984:2008-10
Result, degree of protection, IP code	Finger safety with IP20 test finger

Environmental Product Compliance

China RoHS	Environmentally friendly use period: unlimited = EFUP-e
	No hazardous substances above threshold values

Drawings

Printed-circuit board connector - FRONT-MSTB 2,5/21-ST-5,08 - 1777471

Diagram

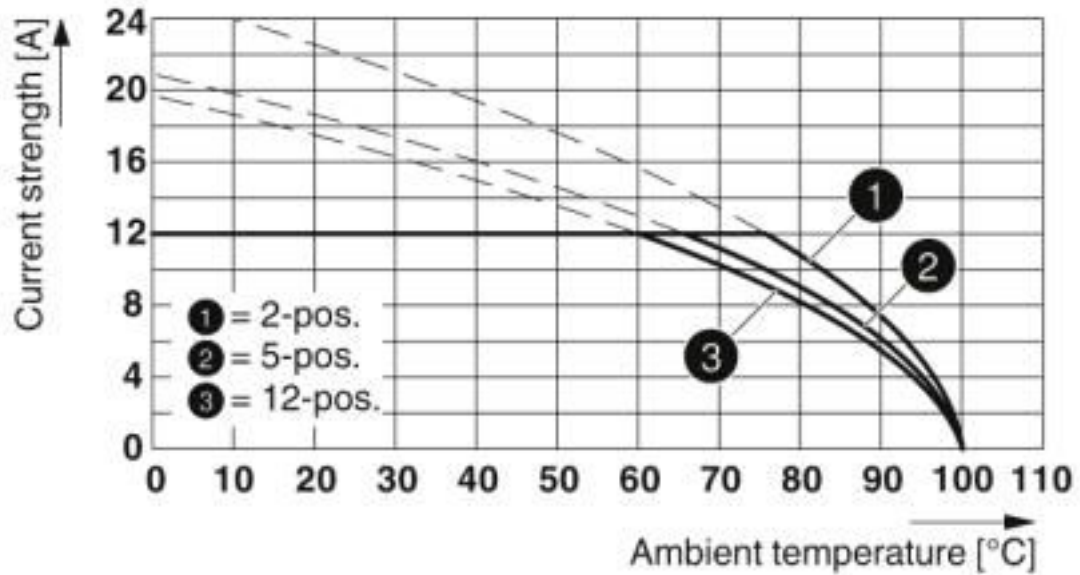

Type: FRONT-MSTB 2,5/...-ST-5,08 with CC 2,5/...-G-5,08 P26THR

Diagram

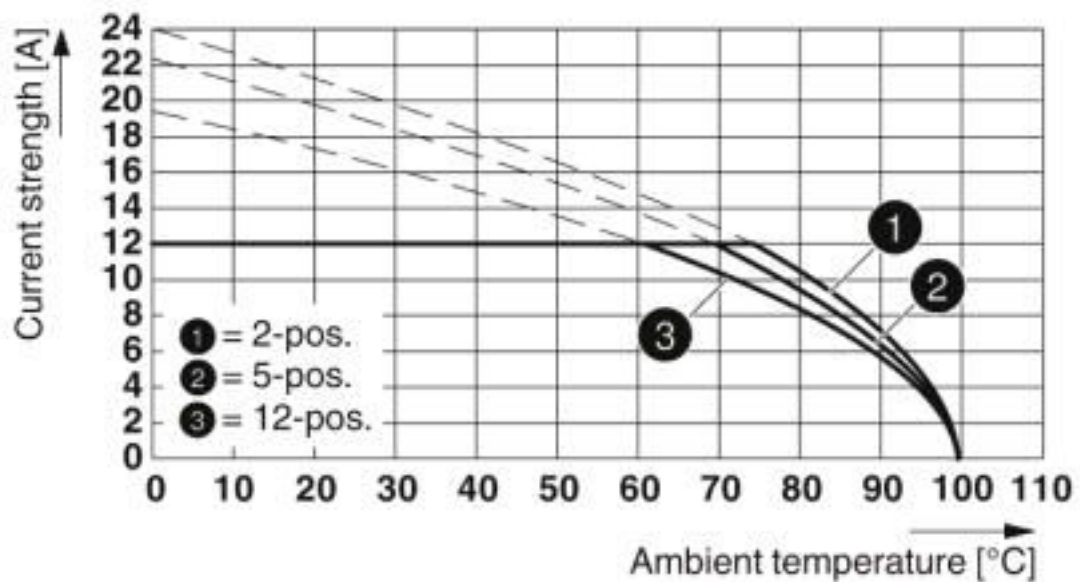

Type: FRONT-MSTB 2,5/...-ST-5,08 with CCV 2,5/...-G-5,08 P26THR

Printed-circuit board connector - FRONT-MSTB 2,5/21-ST-5,08 - 1777471

Diagram

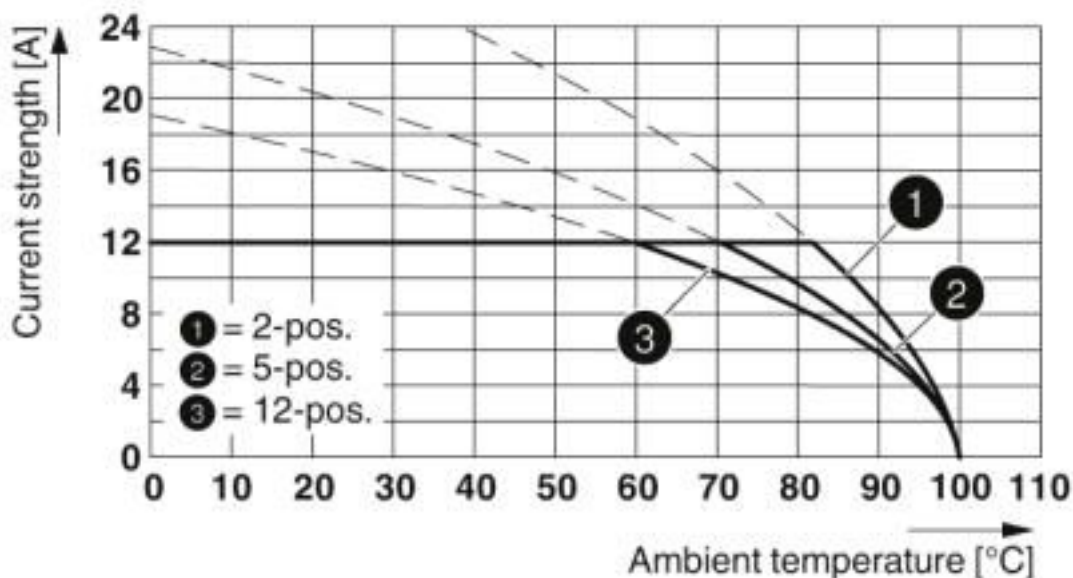

Type: FRONT-MSTB 2,5/...-ST-5,08 with CCVA 2,5/...-G-5,08 P26THR

Diagram

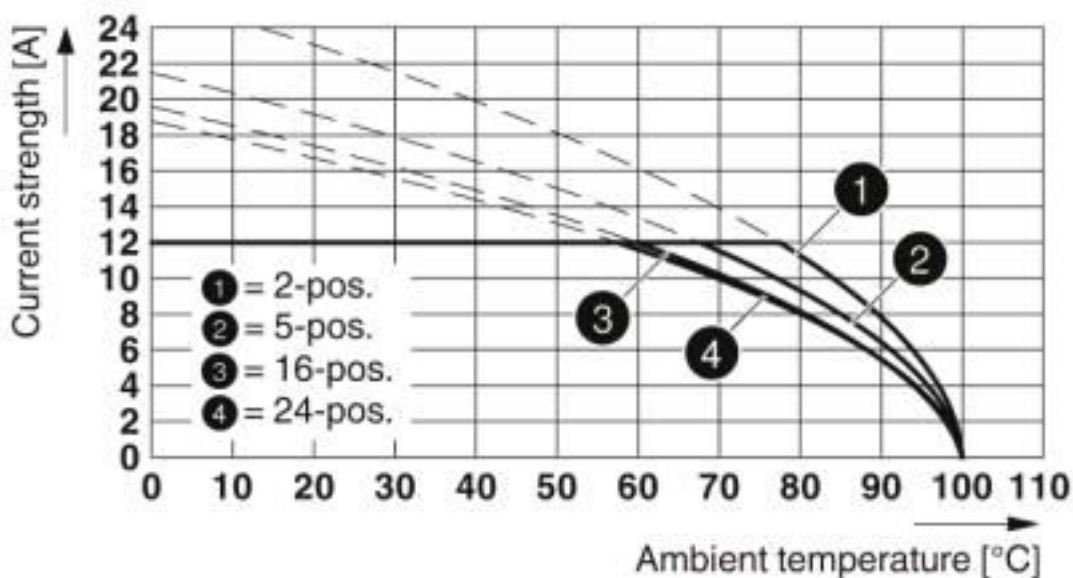

Type: FRONT-MSTB 2,5/...-ST-5,08 with MSTBA 2,5/...-G-5,08

Printed-circuit board connector - FRONT-MSTB 2,5/21-ST-5,08 - 1777471

Diagram

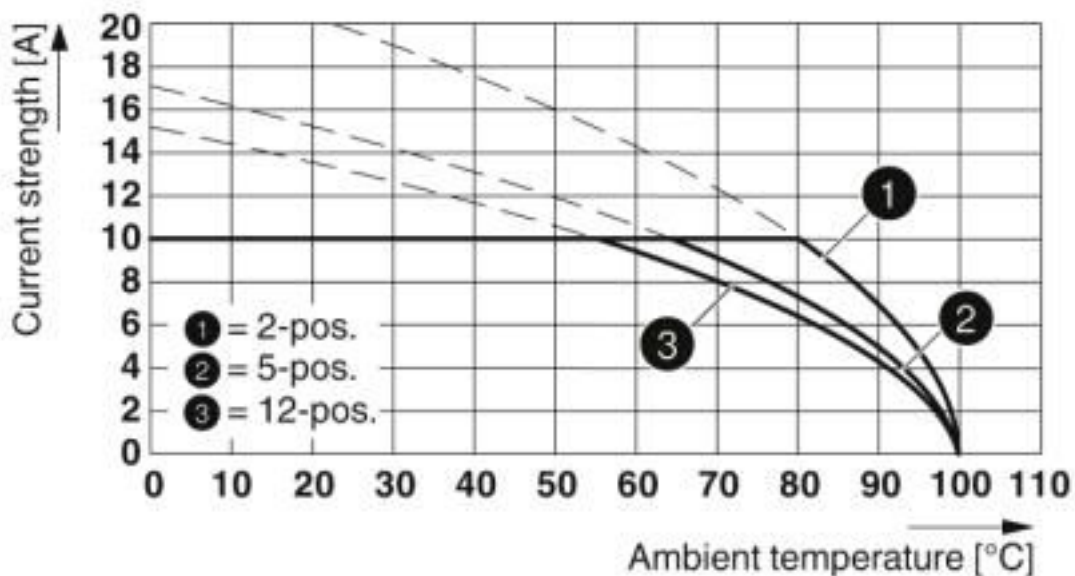

Type: FRONT-MSTB 2,5/...-ST-5,08 with MDSTB 2,5/...-G-5,08

Diagram

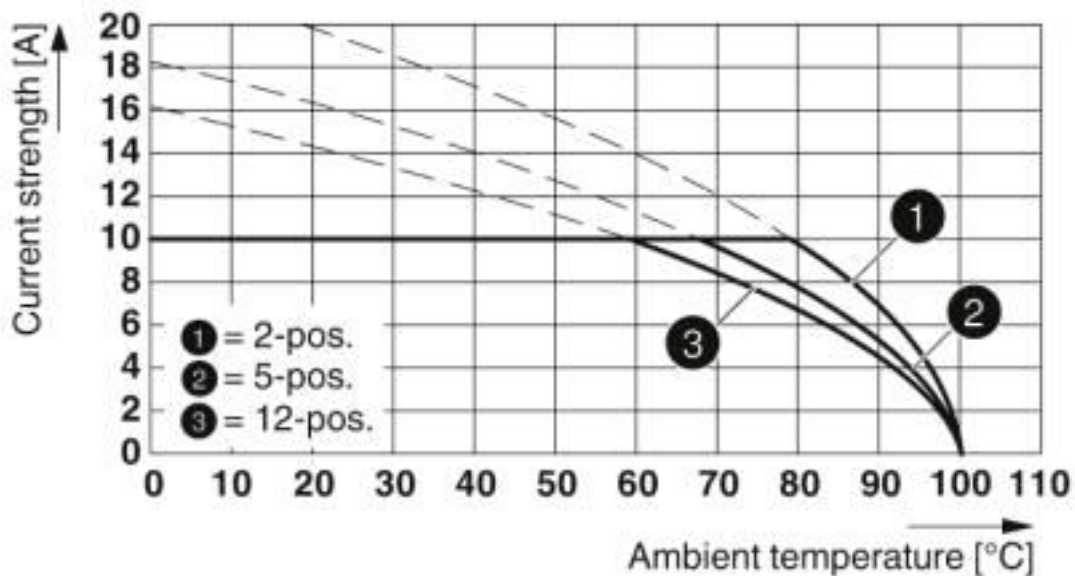

Type: FRONT-MSTB 2,5/...-ST-5,08 with MDSTBA 2,5/...-G-5,08

Printed-circuit board connector - FRONT-MSTB 2,5/21-ST-5,08 - 1777471

Diagram

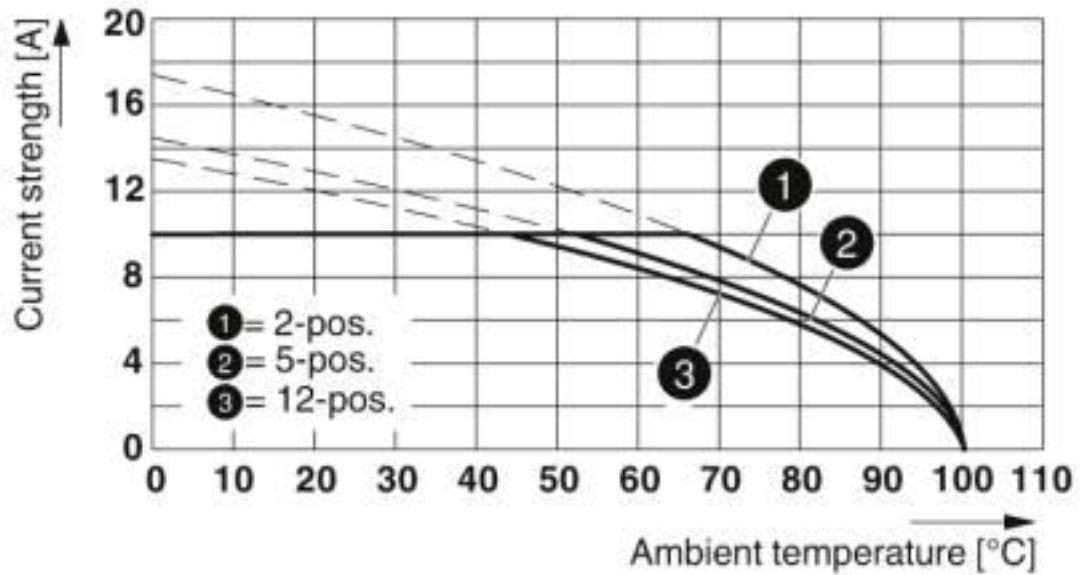

Type: FRONT-MSTB 2,5/...-ST-5,08 with MDSTBV 2,5/...-G-5,08

Diagram

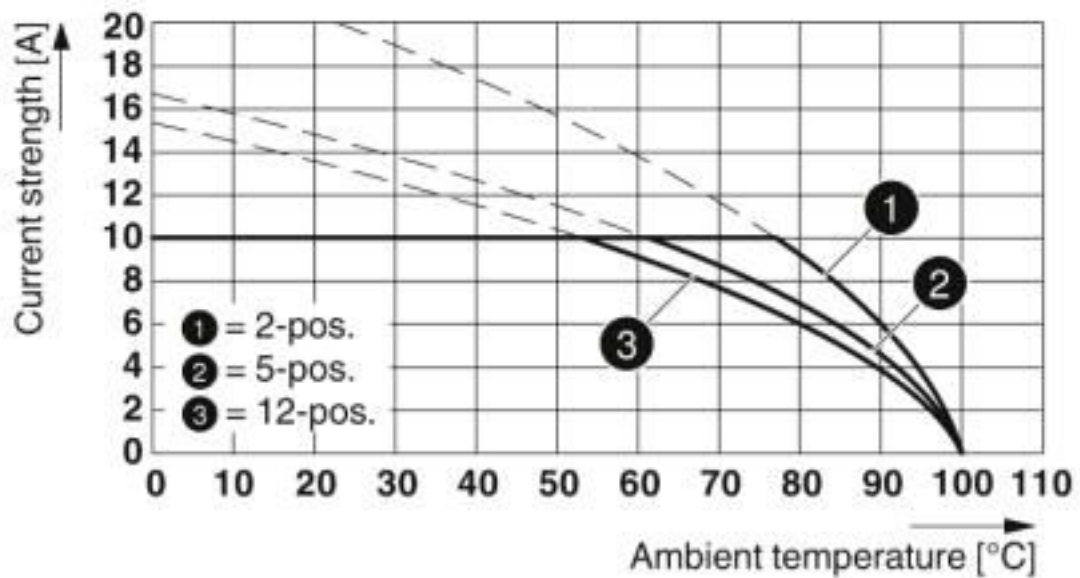

Type: FRONT-MSTB 2,5/...-ST-5,08 with MDSTBW 2,5/...-G-5,08

Printed-circuit board connector - FRONT-MSTB 2,5/21-ST-5,08 - 1777471

Diagram

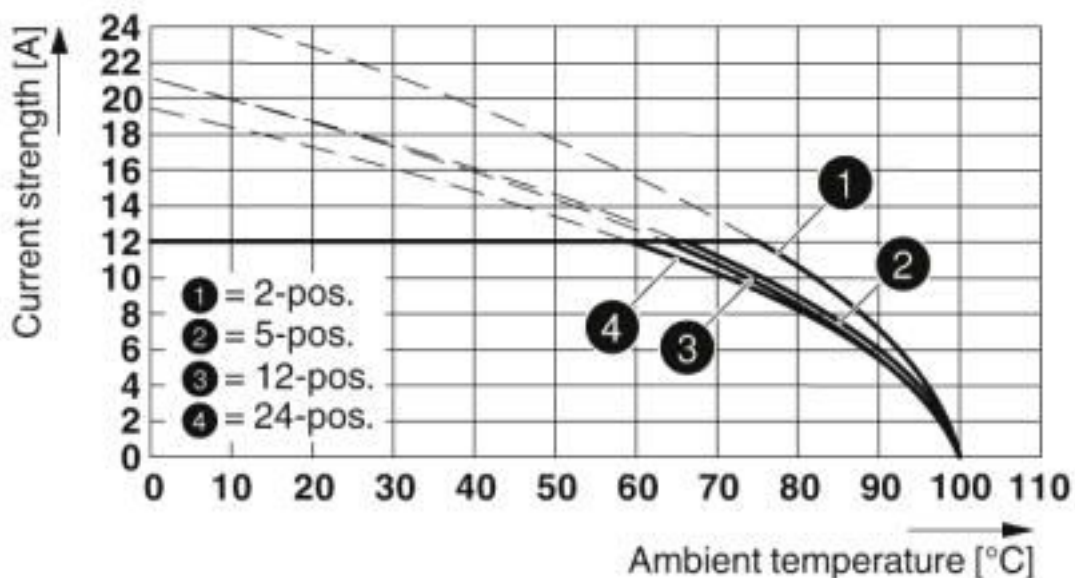

Type: FRONT-MSTB 2,5/...-ST-5,08 with MSTB 2,5/...-G-5,08

Diagram

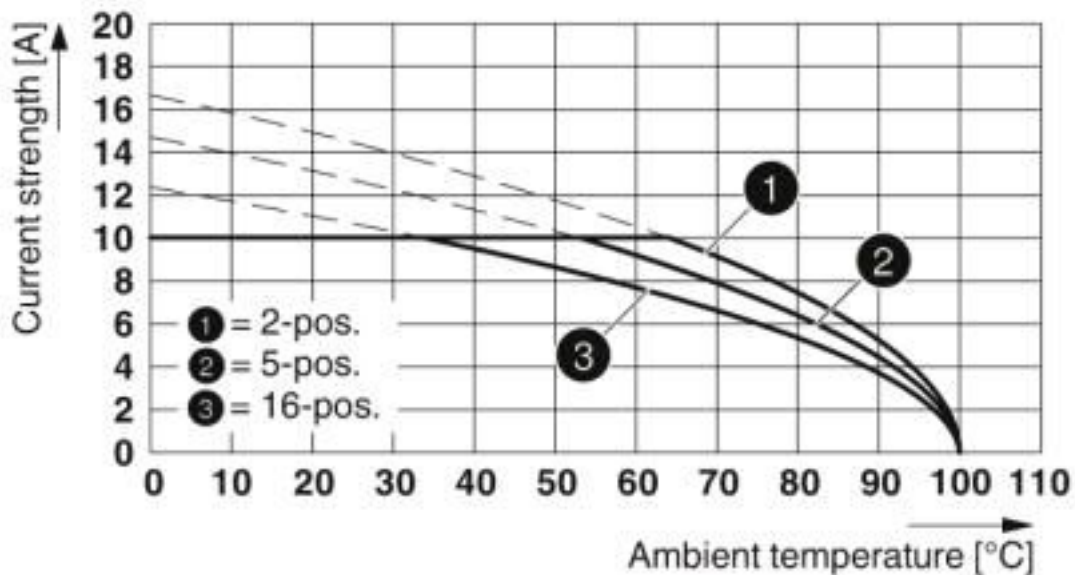

Type: FRONT-MSTB 2,5/...-ST-5,08 with MDSTBVA 2,5/...-G-5,08

Printed-circuit board connector - FRONT-MSTB 2,5/21-ST-5,08 - 1777471

Diagram

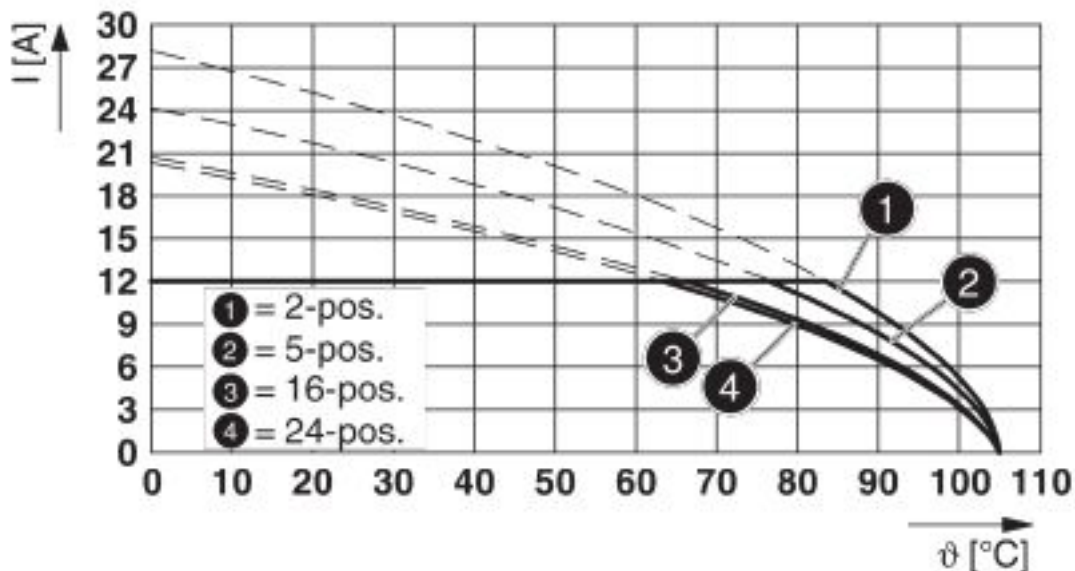

Type: FRONT-MSTB 2,5/...-ST-5,08 with SMSTB 2,5/...-G-5,08

Diagram

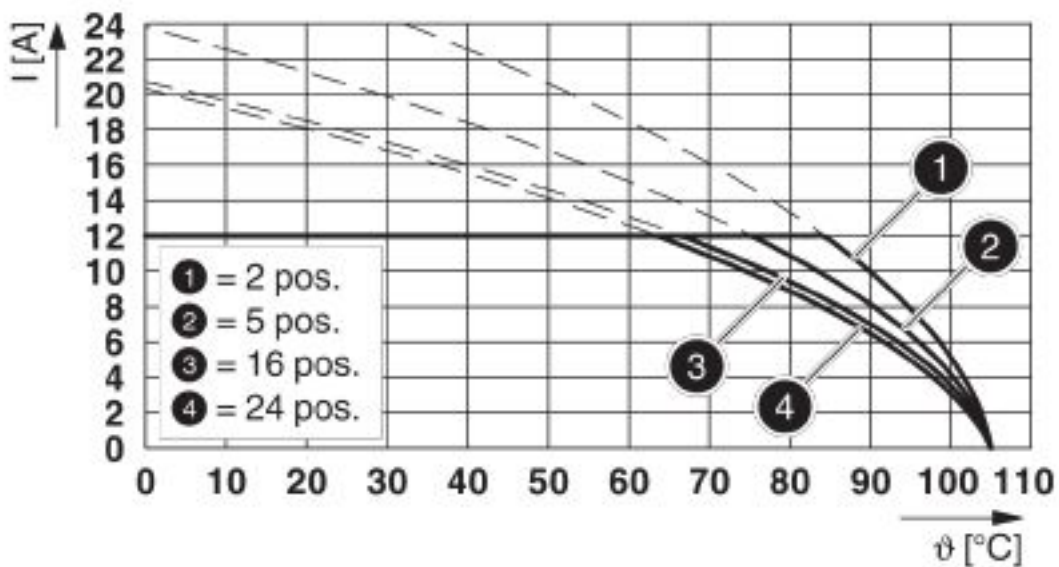

Type: FRONT-MSTB 2,5/...-ST-5,08 with SMSTBA 2,5/...-G-5,08

Printed-circuit board connector - FRONT-MSTB 2,5/21-ST-5,08 - 1777471

Diagram

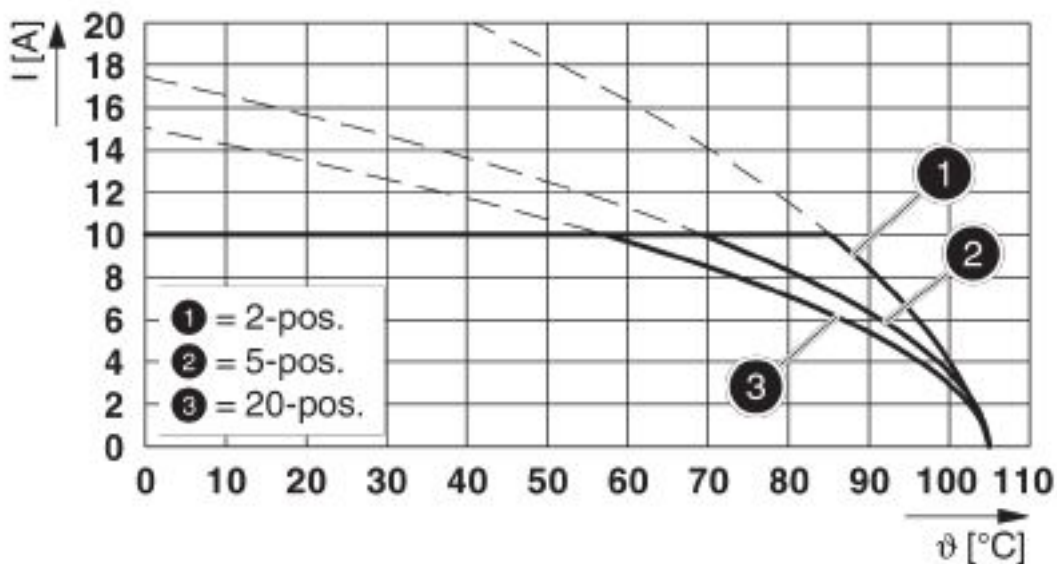

Type: FRONT-MSTB 2,5/...-ST-5,08 with MDSTB 2,5/...-G1-5,08

Diagram

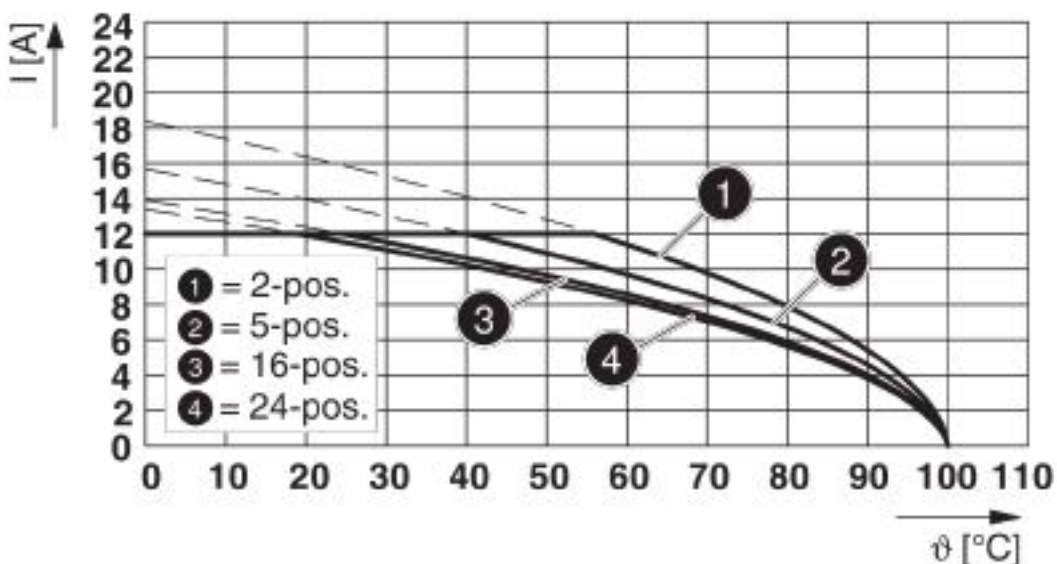

Type: FRONT-MSTB 2,5/...-ST-5,08 with MSTBVA 2,5/...-G-5,08

Printed-circuit board connector - FRONT-MSTB 2,5/21-ST-5,08 - 1777471

Diagram

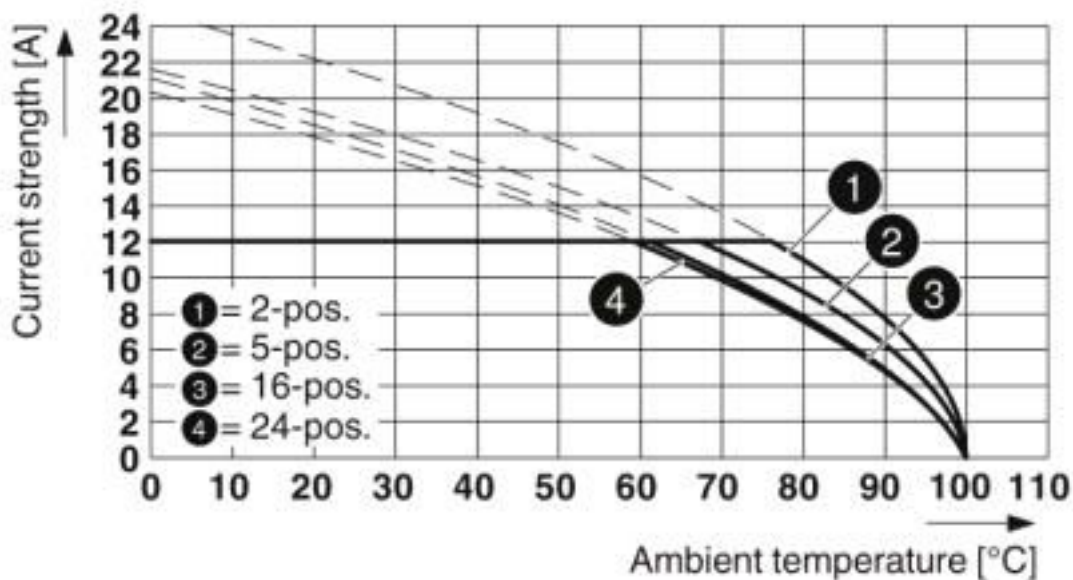

Type: FRONT-MSTB 2,5/...-ST-5,08 with MSTBW 2,5/...-G-5,08

Dimensional drawing

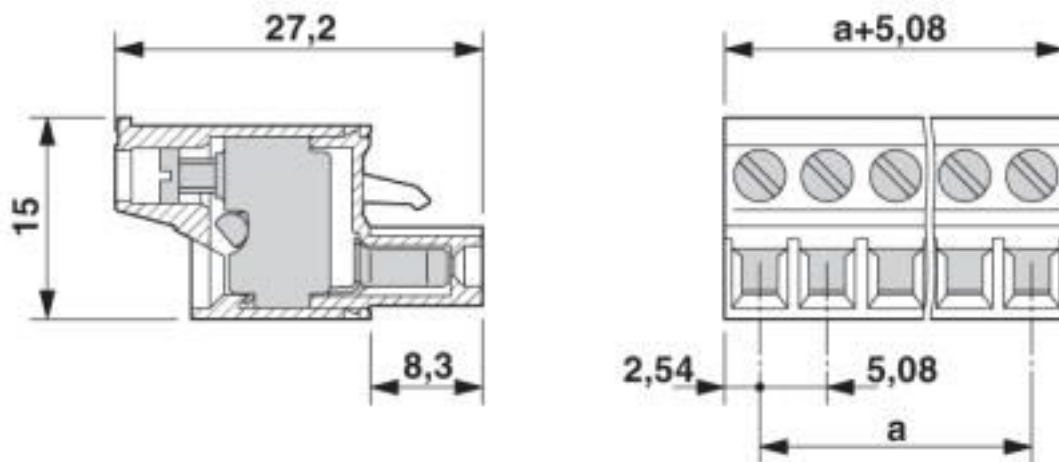

Classifications

eCl@ss

eCl@ss 10.0.1	27440309
eCl@ss 4.0	27260700
eCl@ss 4.1	27260700
eCl@ss 5.0	27260700
eCl@ss 5.1	27260700

Printed-circuit board connector - FRONT-MSTB 2,5/21-ST-5,08 - 1777471

Classifications

eCl@ss

eCl@ss 6.0	27260700
eCl@ss 7.0	27440309
eCl@ss 8.0	27440309
eCl@ss 9.0	27440309

ETIM

ETIM 3.0	EC001121
ETIM 4.0	EC002638
ETIM 5.0	EC002638
ETIM 6.0	EC002638
ETIM 7.0	EC002638

UNSPSC

UNSPSC 6.01	30211810
UNSPSC 7.0901	39121409
UNSPSC 11	39121409
UNSPSC 12.01	39121409
UNSPSC 13.2	39121409
UNSPSC 18.0	39121409
UNSPSC 19.0	39121409
UNSPSC 20.0	39121409
UNSPSC 21.0	39121409

Approvals

Approvals

Approvals

CSA / IEC/EE CB Scheme / EAC / cULus Recognized / VDE Zeichengenehmigung

Ex Approvals

Approval details

CSA		http://www.csagroup.org/services-industries/product-listing/	13631
	B	D	
Nominal voltage UN	300 V	300 V	

Printed-circuit board connector - FRONT-MSTB 2,5/21-ST-5,08 - 1777471

Approvals

	B	D
Nominal current IN	15 A	10 A
mm ² /AWG/kcmil	22-12	22-12

IECEE CB Scheme		http://www.iecee.org/	DE1-60988-B1B2
Nominal voltage UN	250 V		
Nominal current IN	12 A		
mm ² /AWG/kcmil	0.34-2.5		

EAC		B.01687
-----	--	---------

cULus Recognized		http://database.ul.com/cgi-bin/XYV/template/LISEXT/1FRAME/index.htm	E60425-19931011
	B	D	
Nominal voltage UN	300 V	300 V	
Nominal current IN	15 A	10 A	
mm ² /AWG/kcmil	30-12	30-12	

VDE Zeichengenehmigung		http://www2.vde.com/de/Institut/Online-Service/VDE-gepruefteProdukte/Seiten/Online-Suche.aspx	40050694
Nominal voltage UN	250 V		
Nominal current IN	12 A		
mm ² /AWG/kcmil	0.34-2.5		

Accessories

Accessories

Assembly tool

Printed-circuit board connector - FRONT-MSTB 2,5/21-ST-5,08 - 1777471

Accessories

Accessories - FRONT-MSTB-EW - 1763058



Removal aid, for FRONT-MSTB, facilitates extraction of several plugs mounted behind each other

Coding element

Coding profile - CP-MSTB - 1734634



Coding profile, is inserted into the slot on the plug or inverted header, red insulating material

Insertion bridge

Insertion bridge - EBL 2- 5 - 2303145



Insertion bridge, pitch: 5.2 mm, number of positions: 2, color: gray

Insertion bridge - EBL 3- 5 - 2303158



Insertion bridge, pitch: 5.2 mm, number of positions: 3, color: gray

Insertion bridge - EBL 10- 5 - 2303132



Insertion bridge, pitch: 5.2 mm, number of positions: 10, color: gray

Labeled terminal marker

Printed-circuit board connector - FRONT-MSTB 2,5/21-ST-5,08 - 1777471

Accessories

Marker card - SK 5,08/3,8:FORTL.ZAHLEN - 0804293



Marker card, Card, white, labeled, horizontal: consecutive numbers 1 ... 10, 11 ... 20, etc. up to 91 ... (99)100, mounting type: adhesive, for terminal block width: 5.08 mm, lettering field size: 5.08 x 3.8 mm

Marker pen

Marker pen - B-STIFT - 1051993



Marker pen, for manual labeling of unprinted Zack strips, smear-proof and waterproof, line thickness 0.5 mm

Screwdriver tools

Screwdriver - SZS 0,6X3,5 - 1205053



Actuation tool, for ST terminal blocks, insulated, also suitable for use as a bladed screwdriver, size: 0.6 x 3.5 x 100 mm, 2-component grip, with non-slip grip

Terminal marking

Marker card - SK U/2,8 WH:UNBEDRUCKT - 0803883



Marker card, Sheet, white, unlabeled, can be labeled with: PLOTMARK, CMS-P1-PLOTTER, Office printing systems, mounting type: adhesive, for terminal block width: 210 mm, lettering field size: 186 x 2.8 mm, Number of individual labels: 3600

Additional products

Feed-through header - MSTBW 2,5/21-G-5,08 - 1735691



PCB headers, nominal current: 12 A, rated voltage (III/2): 320 V, nominal cross section: 2.5 mm², number of positions: 21, pitch: 5.08 mm, color: green, contact surface: Tin, mounting: Wave soldering, pin layout: Linear pinning, solder pin [P]: 3.5 mm

Printed-circuit board connector - FRONT-MSTB 2,5/21-ST-5,08 - 1777471

Accessories

Printed-circuit board connector - MSTBVA 2,5/21-G-5,08 - 1755927



PCB headers, nominal current: 12 A, rated voltage (III/2): 320 V, nominal cross section: 2.5 mm², number of positions: 21, pitch: 5.08 mm, color: green, contact surface: Tin, mounting: Wave soldering, pin layout: Linear pinning, solder pin [P]: 3.9 mm

Printed-circuit board connector - MSTBA 2,5/21-G-5,08 - 1757433



PCB headers, nominal current: 12 A, rated voltage (III/2): 320 V, nominal cross section: 2.5 mm², number of positions: 21, pitch: 5.08 mm, color: green, contact surface: Tin, mounting: Wave soldering, pin layout: Linear pinning, solder pin [P]: 3.5 mm

Feed-through header - MSTBV 2,5/21-G-5,08 - 1758209



PCB headers, nominal current: 12 A, rated voltage (III/2): 320 V, nominal cross section: 2.5 mm², number of positions: 21, pitch: 5.08 mm, color: green, contact surface: Tin, mounting: Wave soldering, pin layout: Linear pinning, solder pin [P]: 3.9 mm

Feed-through header - MSTB 2,5/21-G-5,08 - 1759208



PCB headers, nominal current: 12 A, rated voltage (III/2): 320 V, nominal cross section: 2.5 mm², number of positions: 21, pitch: 5.08 mm, color: green, contact surface: Tin, mounting: Wave soldering, pin layout: Linear pinning, solder pin [P]: 3.5 mm

Feed-through header - SMSTBA 2,5/21-G-5,08 - 1767562



PCB headers, nominal current: 12 A, rated voltage (III/2): 320 V, nominal cross section: 2.5 mm², number of positions: 21, pitch: 5.08 mm, color: green, contact surface: Tin, mounting: Wave soldering, pin layout: Linear pinning, solder pin [P]: 3.5 mm

Printed-circuit board connector - FRONT-MSTB 2,5/21-ST-5,08 - 1777471

Accessories

Feed-through header - MSTBA 2,5/21-G-5,08-LA - 1768134



PCB headers, number of positions: 21, pitch: 5.08 mm, color: green, contact surface: Tin, pin layout: Linear pinning, solder pin [P]: 3.5 mm

Printed-circuit board connector - SMSTB 2,5/21-G-5,08 - 1769654



PCB headers, nominal current: 12 A, rated voltage (III/2): 320 V, nominal cross section: 2.5 mm², number of positions: 21, pitch: 5.08 mm, color: green, contact surface: Tin, mounting: Wave soldering, pin layout: Linear pinning, solder pin [P]: 3.5 mm

Phoenix Contact 2020 © - all rights reserved
<http://www.phoenixcontact.com>

PHOENIX CONTACT GmbH & Co. KG
Flachsmarktstr. 8
32825 Blomberg
Germany
Tel. +49 5235 300
Fax +49 5235 3 41200
<http://www.phoenixcontact.com>

X-ON Electronics

Largest Supplier of Electrical and Electronic Components

Click to view similar products for [Pluggable Terminal Blocks](#) category:

Click to view products by [Phoenix Contact](#) manufacturer:

Other Similar products are found below :

[57.510.0053](#) [MC 1.5/ 6-ST-3.5 GY AU](#) [734-104](#) [734-302](#) [8-141-P](#) [8426620000](#) [860505](#) [860810](#) [GBPACX-12](#) [93.731.4953.0](#) [PV05-5,08-K](#)
[PVP02-5,00](#) [PVP03-3,50](#) [PVP04-3,50](#) [PVS02-5,00](#) [1-1986160-3](#) [1377680000](#) [1531000000](#) [1546228-5](#) [ELFH16150](#) [ELFP03110](#)
[ELFP10210](#) [ELFT06250](#) [ELVP03100](#) [1700101](#) [1700410](#) [1700425](#) [1702246](#) [1705229](#) [1710175](#) [1714537](#) [1717806](#) [1719600](#) [1728941](#)
[1734692](#) [1734795](#) [1736036](#) [1740194](#) [1740291](#) [1740628](#) [1740990](#) [1746952](#) [1750207](#) [1752441](#) [1752865](#) [1754115](#) [1754144](#) [1756913](#)
[1760051](#) [1760336](#)