

# Printed-circuit board connector - FRONT-MSTB 2,5/11-STF-5,08 - 1777882

Please be informed that the data shown in this PDF Document is generated from our Online Catalog. Please find the complete data in the user's documentation. Our General Terms of Use for Downloads are valid (<http://phoenixcontact.com/download>)

PCB connector, nominal current: 12 A, rated voltage (III/2): 320 V, nominal cross section: 2.5 mm<sup>2</sup>, number of positions: 11, pitch: 5.08 mm, connection method: Front screw connection, color: green, contact surface: Tin



The figure shows a 10-position version of the product

## Your advantages

- ✓ Well-known connection principle allows worldwide use
- ✓ Optimized for tight installation situations: operation and conductor connection from one direction
- ✓ Screwable flange for superior mechanical stability
- ✓ Low temperature rise, thanks to maximum contact force
- ✓ Allows connection of two conductors



## Key Commercial Data

Packing unit	50 pc
Minimum order quantity	50 pc
GTIN	
GTIN	4017918039752

## Technical data

### Item properties

Brief article description	Printed-circuit board connector
Plug-in system	CLASSIC COMBICON
Type of contact	Female connector
Range of articles	FRONT-MSTB 2,5/...-STF
Pitch	5.08 mm
Number of positions	11
Connection method	Front screw connection
Drive form screw head	Slotted

# Printed-circuit board connector - FRONT-MSTB 2,5/11-STF-5,08 - 1777882

## Technical data

### Item properties

Screw thread	M2,5
Locking	Screw flange
Number of levels	1
Number of connections	11
Number of potentials	11

### Electrical parameters

Nominal current	12 A
Nom. voltage	320 V
Rated voltage	250 V
Rated voltage (III/2)	320 V
Rated voltage (II/2)	630 V
Rated surge voltage (III/3)	4 kV
Rated surge voltage (III/2)	4 kV
Rated surge voltage (II/2)	4 kV

### Connection capacity

Connection method	Front screw connection
pluggable	Yes
Conductor cross section solid	0.34 mm <sup>2</sup> ... 2.5 mm <sup>2</sup>
Conductor cross section flexible	0.2 mm <sup>2</sup> ... 2.5 mm <sup>2</sup>
Conductor cross section AWG / kcmil	24 ... 12
Conductor cross section flexible, with ferrule without plastic sleeve	0.25 mm <sup>2</sup> ... 2.5 mm <sup>2</sup>
Conductor cross section, flexible, with ferrule, with plastic sleeve	0.25 mm <sup>2</sup> ... 2.5 mm <sup>2</sup>
2 conductors with same cross section, solid	0.2 mm <sup>2</sup> ... 1.5 mm <sup>2</sup>
2 conductors with same cross section, flexible	0.2 mm <sup>2</sup> ... 1.5 mm <sup>2</sup>
2 conductors with same cross section, flexible, with ferrule without plastic sleeve	0.25 mm <sup>2</sup> ... 1 mm <sup>2</sup>
2 conductors with the same cross section, flexible, with TWIN ferrule with plastic sleeve	0.5 mm <sup>2</sup> ... 1 mm <sup>2</sup>
Cylindrical gauge a x b / diameter	2.8 mm x 2.0 mm / 2.4 mm
Stripping length	10 mm
Torque	0.5 Nm ... 0.6 Nm

### Specifications for ferrules

Recommended crimping pliers	1212034 CRIMPFOX 6
Ferrules without insulating collar, according to DIN 46228-1	Cross section: 0.5 mm <sup>2</sup> ; Length: 8 mm ... 10 mm
	Cross section: 0.75 mm <sup>2</sup> ; Length: 8 mm ... 10 mm
	Cross section: 1 mm <sup>2</sup> ; Length: 8 mm ... 10 mm
	Cross section: 1.5 mm <sup>2</sup> ; Length: 8 mm ... 10 mm
	Cross section: 2.5 mm <sup>2</sup> ; Length: 10 mm
Recommended crimping pliers	1212034 CRIMPFOX 6

# Printed-circuit board connector - FRONT-MSTB 2,5/11-STF-5,08 - 1777882

## Technical data

### Specifications for ferrules

Ferrules with insulating collar, according to DIN 46228-4	Cross section: 0.5 mm <sup>2</sup> ; Length: 8 mm ... 10 mm
	Cross section: 0.75 mm <sup>2</sup> ; Length: 8 mm ... 10 mm
	Cross section: 1 mm <sup>2</sup> ; Length: 8 mm ... 10 mm
	Cross section: 1.5 mm <sup>2</sup> ; Length: 8 mm ... 10 mm
	Cross section: 2.5 mm <sup>2</sup> ; Length: 10 mm

### Flange specifications

Type of locking	Screw locking
Mounting flange	Screw flange

### Material data - contact

Note	WEEE/RoHS-compliant, free of whiskers according to IEC 60068-2-82/ JEDEC JESD 201
Contact material	Cu alloy
Surface characteristics	hot-dip tin-plated
Metal surface terminal point (top layer)	Tin (4 - 8 µm Sn)
Metal surface contact area (top layer)	Tin (4 - 8 µm Sn)

### Material data - housing

Housing color	green (6021)
Insulating material	PA
Insulating material group	I
CTI according to IEC 60112	600
Flammability rating according to UL 94	V0
Glow wire flammability index GWFI according to EN 60695-2-12	850
Glow wire ignition temperature GWIT according to EN 60695-2-13	775
Temperature for the ball pressure test according to EN 60695-10-2	125 °C

### Dimensions for the product

Length [ l ]	27.2 mm
Width [ w ]	65.68 mm
Height [ h ]	15 mm
Pitch	5.08 mm
Height (without solder pin)	15 mm

### Packaging information

Type of packaging	packed in cardboard
Pieces per package	50
Denomination packing units	Pcs.

### General product information

Note	In accordance with IEC 61984, COMBICON connectors have no switching power (COC). During designated use, they must not be plugged in or disconnected when carrying voltage or under load.
------	--

# Printed-circuit board connector - FRONT-MSTB 2,5/11-STF-5,08 - 1777882

## Technical data

### Ambient conditions

Ambient temperature (storage/transport)	-40 °C ... 70 °C
Ambient temperature (assembly)	-5 °C ... 100 °C
Ambient temperature (operation)	-40 °C ... 100 °C (dependent on the derating curve)

### Termination and connection method

Test for conductor damage and slackening	IEC 60999-1:1999-11
	Test passed

### Pull-out test

Pull-out test	IEC 60999-1:1999-11
	Test passed
Conductor cross section / conductor type / tensile force	0.34 mm <sup>2</sup> / solid / > 15 N
	0.2 mm <sup>2</sup> / flexible / > 10 N
	2.5 mm <sup>2</sup> / solid / > 50 N
	2.5 mm <sup>2</sup> / flexible / > 50 N

### Mechanical tests according to standard

Test specification	IEC 61984
Visual inspection	IEC 60512-1-1:2002-02
Dimension check	IEC 60512-1-2:2002-02
Resistance of inscriptions	IEC 60068-2-70:1995-12
Insertion and withdrawal force	IEC 60512-13-2:2006-02
No. of cycles	25
Insertion strength per pos. approx.	12 N
Withdraw strength per pos. approx.	9 N
Polarization and coding	IEC 60512-13-5:2006-02
Contact holder in insert	IEC 60512-15-1:2008-05
Test force per pos.	44 N

### Air clearances and creepage distances

Clearances and creepage distances	IEC 60664-1:2007-04
Specification	IEC 60664-1:2007-04
Minimum clearance - inhomogeneous field (III/3)	3 mm
Minimum clearance - inhomogeneous field (III/2)	3 mm
Minimum clearance - inhomogeneous field (II/2)	3 mm
Minimum creepage distance value (III/3)	3.2 mm
Minimum creepage distance value (III/2)	3 mm
Minimum creepage distance value (II/2)	3.2 mm

### Current carrying capacity / derating curves

Caption	Type: FRONT-MSTB 2,5/...-STF-5,08 with MDSTB 2,5/...-GF-5,08
Specification	IEC 61984:2008-10

# Printed-circuit board connector - FRONT-MSTB 2,5/11-STF-5,08 - 1777882

## Technical data

### Current carrying capacity / derating curves

Reduction factor	0.8
Note	Representation based on IEC 60512-5-2:2002-02
	For number of positions, see diagram

### Mechanical tests (A)

Test specification	IEC 61984
Insertion strength per pos. approx.	12 N
Withdraw strength per pos. approx.	9 N
Polarization when inserted requirement >20 N	Test passed
Contact holder in insert requirements >20 N	Test passed

### Durability tests (B)

Specification	IEC 60512-9-1:2010-03
Contact resistance R <sub>1</sub>	1.9 mΩ
Insertion/withdrawal cycles	25
Contact resistance R <sub>2</sub>	1.9 mΩ
Impulse withstand voltage at sea level	4.8 kV
Power-frequency withstand voltage	2.21 kV
Insulation resistance, neighboring positions	> 0.2 TΩ

### Thermal tests (C)

Specification	IEC 60512-5-1:2002-02
Number of positions	17
Conductor cross section	2.5 mm <sup>2</sup>
Test current	10 A
Upper limiting temperature requirements <100 °C	Test passed

### Climatic tests (D)

Specification	ISO 6988:1985-02
Cold stress	-40 °C/2 h
Thermal stress	100 °C/168 h
Corrosive stress	0.2 dm <sup>3</sup> SO <sub>2</sub> on 300 dm <sup>3</sup> /40 °C/1 cycle
Impulse withstand voltage at sea level	4.8 kV
Power-frequency withstand voltage	2.21 kV

### Environmental and durability tests (E)

Specification	IEC 61984:2008-10
Result, degree of protection, IP code	Finger safety with IP20 test finger

### Environmental Product Compliance

China RoHS	Environmentally friendly use period: unlimited = EFUP-e
	No hazardous substances above threshold values

# Printed-circuit board connector - FRONT-MSTB 2,5/11-STF-5,08 - 1777882

## Drawings

Diagram

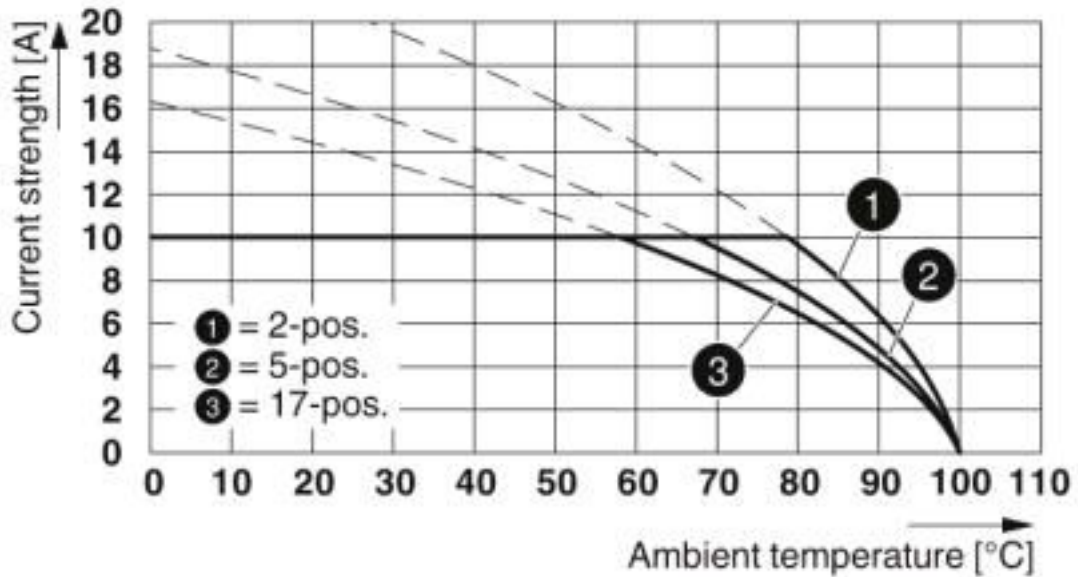

Type: FRONT-MSTB 2,5/...-STF-5,08 with MDSTB 2,5/...-GF-5,08

Diagram

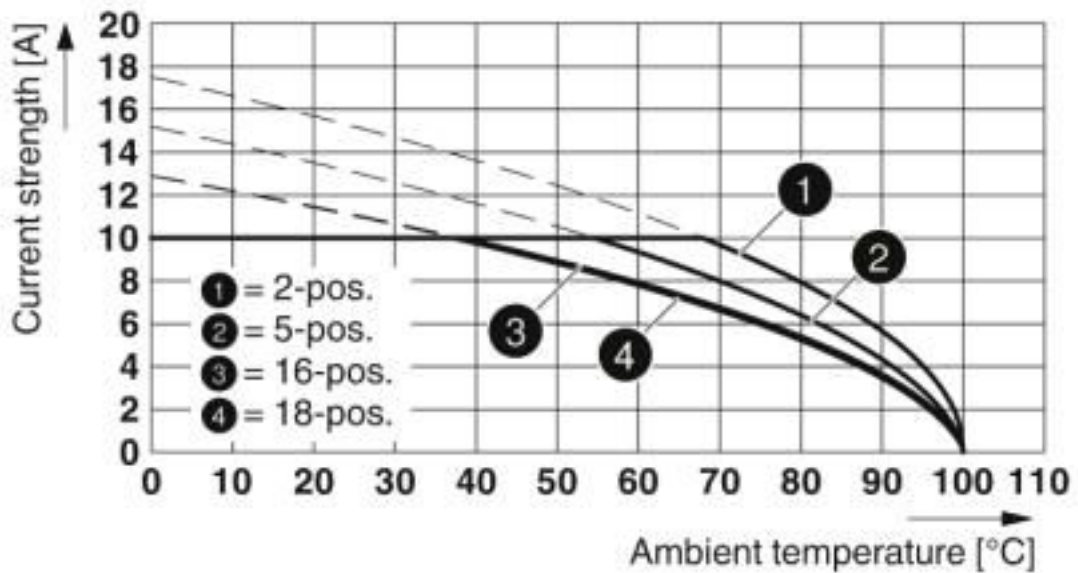

Type: FRONT-MSTB 2,5/...-STF-5,08 with MDSTBV 2,5/...-GF-5,08

# Printed-circuit board connector - FRONT-MSTB 2,5/11-STF-5,08 - 1777882

Diagram

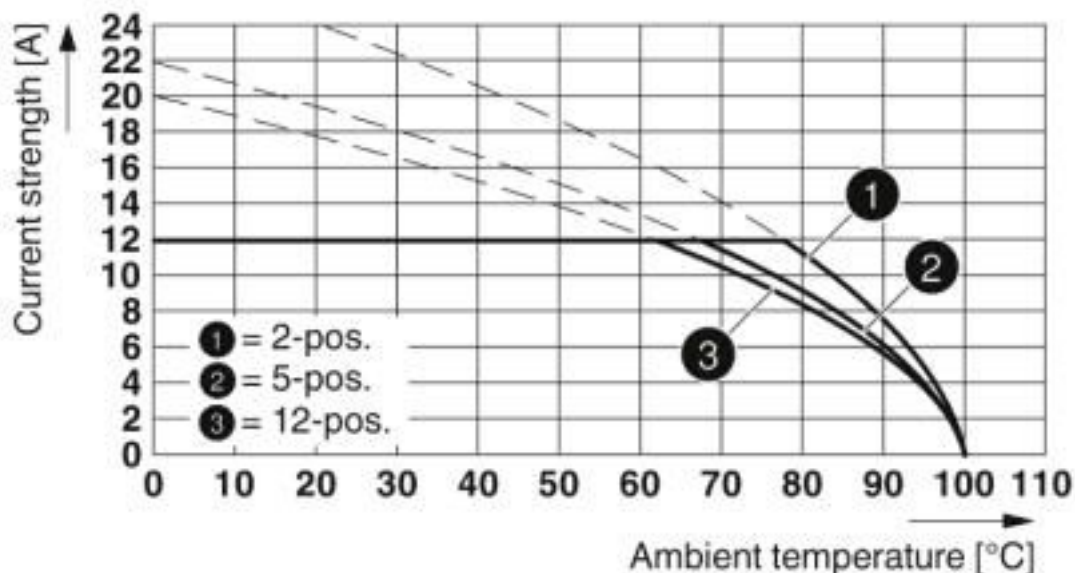

Type: FRONT-MSTB 2,5/...-STF-5,08 with CC 2,5/...-GF-5,08 P26THR

Diagram

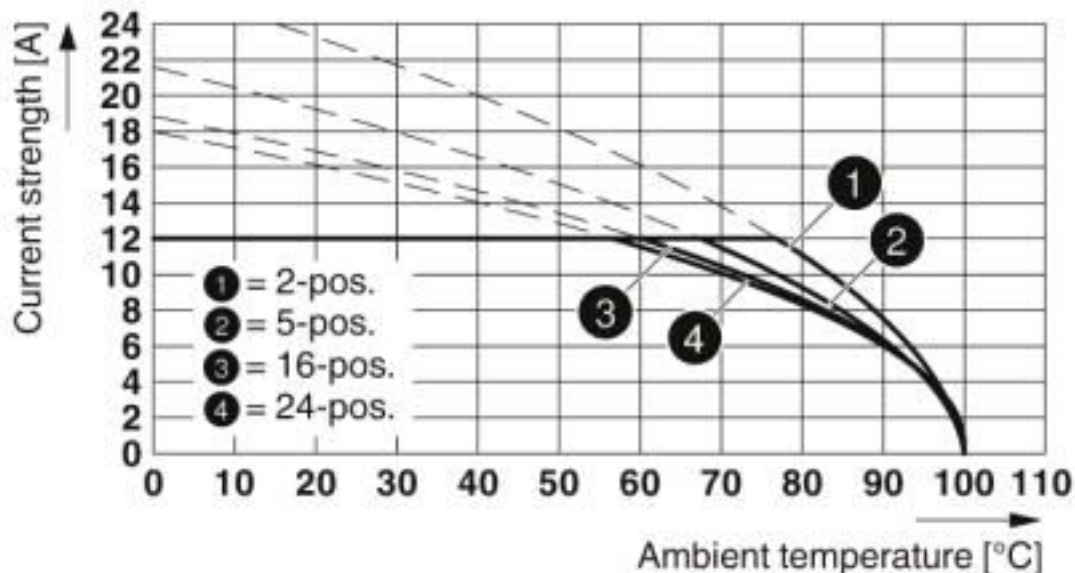

Type: FRONT-MSTB 2,5/...-STF-5,08 with MSTB 2,5/...-GF-5,08

# Printed-circuit board connector - FRONT-MSTB 2,5/11-STF-5,08 - 1777882

Diagram

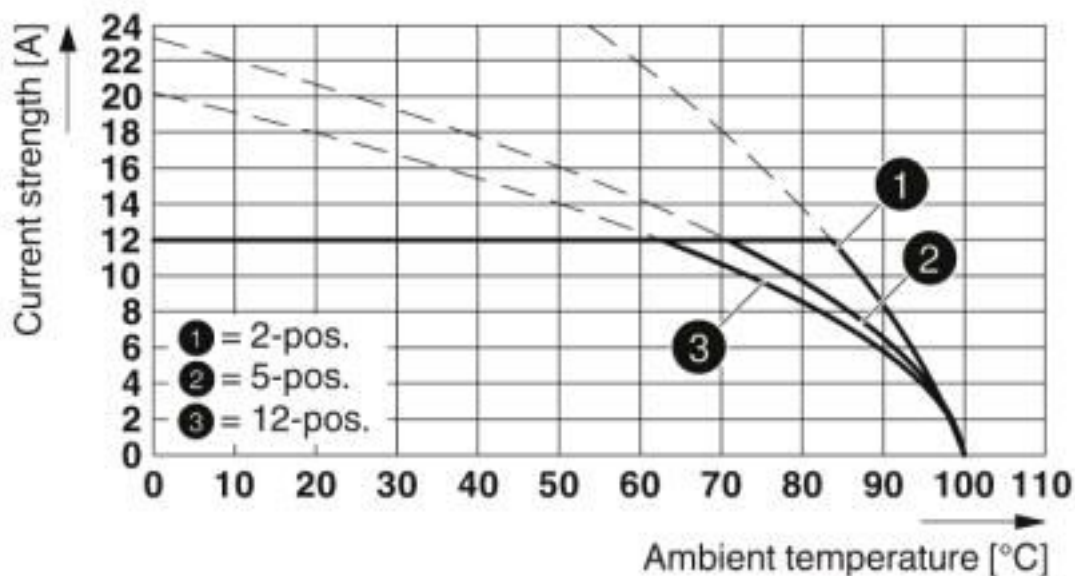

Type: FRONT-MSTB 2,5/...-STF-5,08 with CCV 2,5/...-GF-5,08 P26THR

Diagram

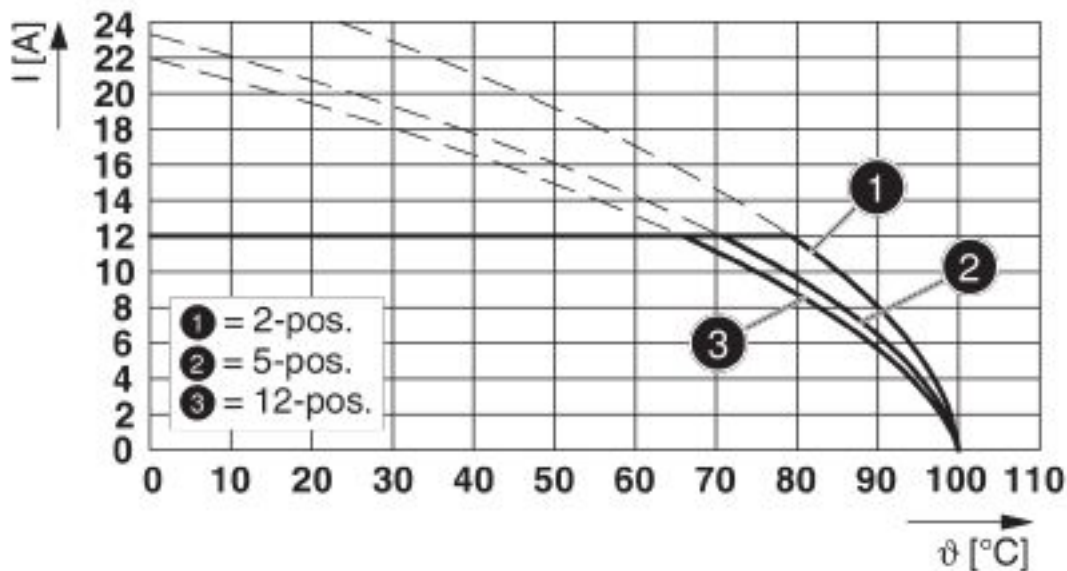

Type: FRONT-MSTB 2,5/...-STF-5,08 with CC 2,5/...-GF-5,08-LR P...THR



# Printed-circuit board connector - FRONT-MSTB 2,5/11-STF-5,08 - 1777882

Diagram

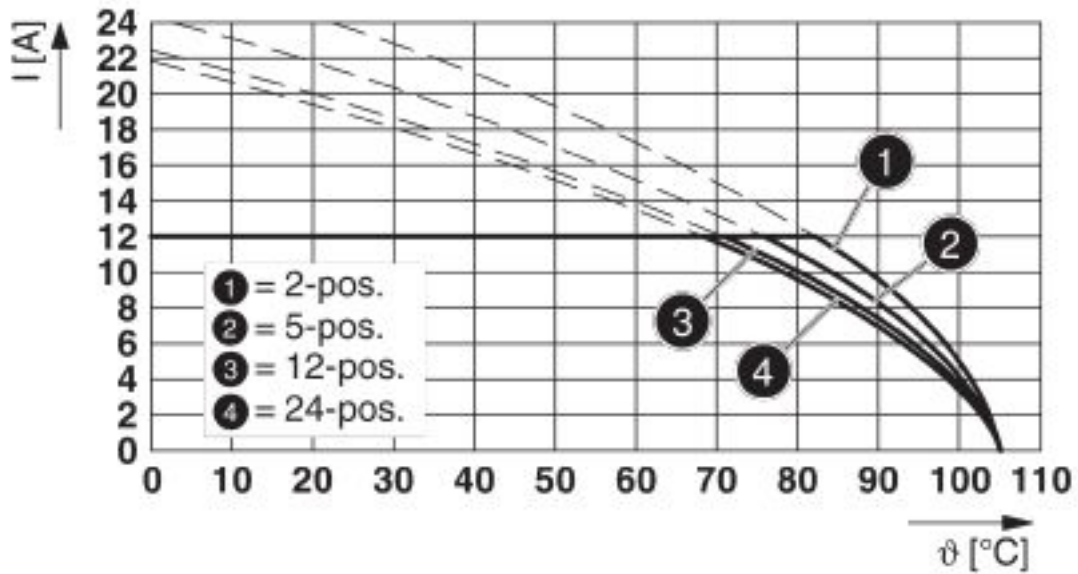

Type: FRONT-MSTB 2,5/...-STF-5,08 with CCV 2,5/...-GF-5,08-LR P...THR

Diagram

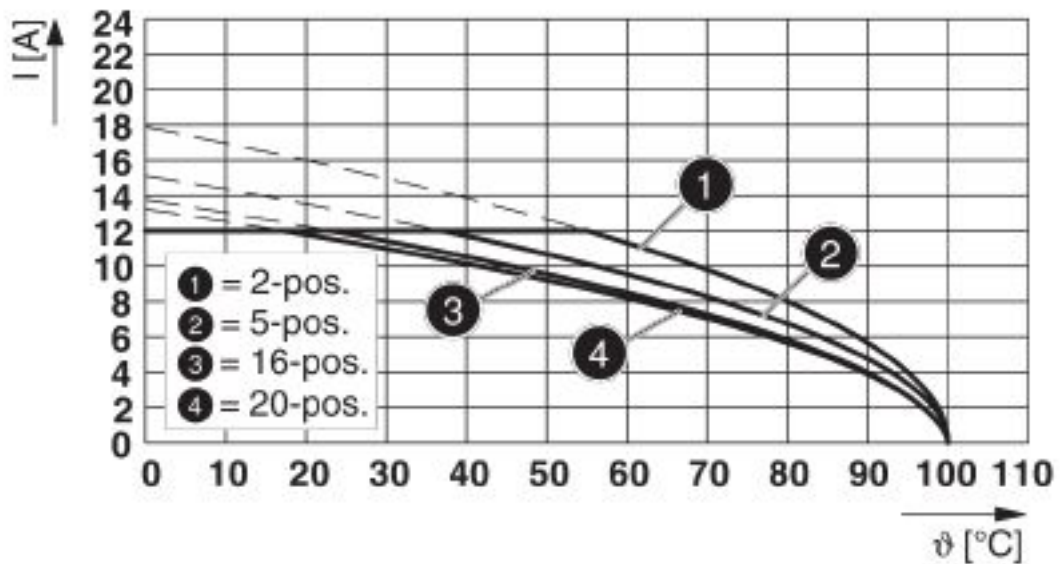

Type: FRONT-MSTB 2,5/...-STF-5,08 with MSTBV 2,5/...-GF-5,08

# Printed-circuit board connector - FRONT-MSTB 2,5/11-STF-5,08 - 1777882

Dimensional drawing

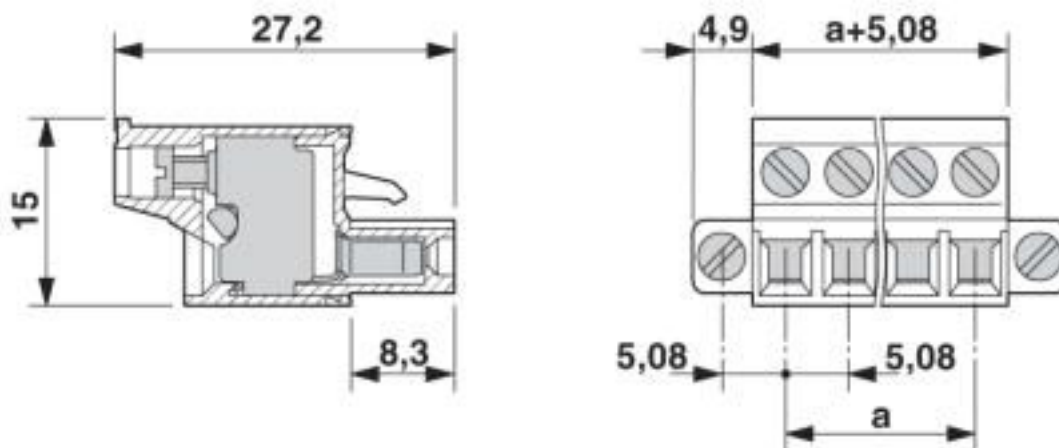

## Classifications

### eCl@ss

eCl@ss 10.0.1	27440309
eCl@ss 4.0	27260700
eCl@ss 4.1	27260700
eCl@ss 5.0	27260700
eCl@ss 5.1	27260700
eCl@ss 6.0	27260700
eCl@ss 7.0	27440309
eCl@ss 8.0	27440309
eCl@ss 9.0	27440309

### ETIM

ETIM 3.0	EC001121
ETIM 4.0	EC002638
ETIM 5.0	EC002638
ETIM 6.0	EC002638
ETIM 7.0	EC002638

### UNSPSC

UNSPSC 6.01	30211810
UNSPSC 7.0901	39121409
UNSPSC 11	39121409
UNSPSC 12.01	39121409
UNSPSC 13.2	39121409
UNSPSC 18.0	39121409
UNSPSC 19.0	39121409

# Printed-circuit board connector - FRONT-MSTB 2,5/11-STF-5,08 - 1777882

## Classifications

### UNSPSC

UNSPSC 20.0	39121409
UNSPSC 21.0	39121409

## Approvals

### Approvals

#### Approvals

DNV GL / CSA / IECCEB Scheme / EAC / cULus Recognized / VDE Zeichengenehmigung

#### Ex Approvals

### Approval details

DNV GL		<a href="https://approvalfinder.dnvgl.com/">https://approvalfinder.dnvgl.com/</a>	TAE00001EY
--------	--	---	------------

CSA		<a href="http://www.csagroup.org/services-industries/product-listing/">http://www.csagroup.org/services-industries/product-listing/</a>	13631
	B	D	
Nominal voltage UN	300 V	300 V	
Nominal current IN	15 A	10 A	
mm <sup>2</sup> /AWG/kcmil	22-12	22-12	

IECCEB Scheme		<a href="http://www.iecee.org/">http://www.iecee.org/</a>	DE1-60988-B1B2
Nominal voltage UN	250 V		
Nominal current IN	12 A		
mm <sup>2</sup> /AWG/kcmil	0.34-2.5		

EAC		B.01687
-----	--	---------

# Printed-circuit board connector - FRONT-MSTB 2,5/11-STF-5,08 - 1777882

## Approvals

cULus Recognized		<a href="http://database.ul.com/cgi-bin/XYV/template/LISEXT/1FRAME/index.htm">http://database.ul.com/cgi-bin/XYV/template/LISEXT/1FRAME/index.htm</a>	E60425-19931011
	B	D	
Nominal voltage UN	300 V	300 V	
Nominal current IN	15 A	10 A	
mm <sup>2</sup> /AWG/kcmil	30-12	30-12	

VDE Zeichengenehmigung		<a href="http://www2.vde.com/de/Institut/Online-Service/VDE-gepruefteProdukte/Seiten/Online-Suche.aspx">http://www2.vde.com/de/Institut/Online-Service/VDE-gepruefteProdukte/Seiten/Online-Suche.aspx</a>	40050694
Nominal voltage UN	250 V		
Nominal current IN	12 A		
mm <sup>2</sup> /AWG/kcmil	0.34-2.5		

## Accessories

### Accessories

#### Assembly tool

Accessories - FRONT-MSTB-EW - 1763058



Removal aid, for FRONT-MSTB, facilitates extraction of several plugs mounted behind each other

### Coding element

Coding profile - CP-MSTB - 1734634



Coding profile, is inserted into the slot on the plug or inverted header, red insulating material

### Insertion bridge

## Printed-circuit board connector - FRONT-MSTB 2,5/11-STF-5,08 - 1777882

### Accessories

Insertion bridge - EBL 10- 5 - 2303132



Insertion bridge, pitch: 5.2 mm, number of positions: 10, color: gray

---

Insertion bridge - EBL 2- 5 - 2303145



Insertion bridge, pitch: 5.2 mm, number of positions: 2, color: gray

---

Insertion bridge - EBL 3- 5 - 2303158



Insertion bridge, pitch: 5.2 mm, number of positions: 3, color: gray

---

Insertion bridge - EBL 4- 5 - 2303161



Insertion bridge, pitch: 5.2 mm, number of positions: 4, color: gray

---

Insertion bridge - EBL 5- 5 - 2303174



Insertion bridge, pitch: 5.2 mm, number of positions: 5, color: gray

---

### Labeled terminal marker

## Printed-circuit board connector - FRONT-MSTB 2,5/11-STF-5,08 - 1777882

### Accessories

Marker card - SK 5,08/3,8:FORTL.ZAHLEN - 0804293



Marker card, Card, white, labeled, horizontal: consecutive numbers 1 ... 10, 11 ... 20, etc. up to 91 ... (99)100, mounting type: adhesive, for terminal block width: 5.08 mm, lettering field size: 5.08 x 3.8 mm

---

### Marker pen

Marker pen - B-STIFT - 1051993



Marker pen, for manual labeling of unprinted Zack strips, smear-proof and waterproof, line thickness 0.5 mm

---

### Screwdriver tools

Screwdriver - SZS 0,6X3,5 - 1205053



Actuation tool, for ST terminal blocks, insulated, also suitable for use as a bladed screwdriver, size: 0.6 x 3.5 x 100 mm, 2-component grip, with non-slip grip

---

### Terminal marking

Marker card - SK U/2,8 WH:UNBEDRUCKT - 0803883



Marker card, Sheet, white, unlabeled, can be labeled with: PLOTMARK, CMS-P1-PLOTTER, Office printing systems, mounting type: adhesive, for terminal block width: 210 mm, lettering field size: 186 x 2.8 mm, Number of individual labels: 3600

---

### Additional products

Feed-through header - MSTB 2,5/11-GF-5,08 - 1776595



PCB headers, nominal current: 12 A, rated voltage (III/2): 320 V, nominal cross section: 2.5 mm<sup>2</sup>, number of positions: 11, pitch: 5.08 mm, color: green, contact surface: Tin, mounting: Wave soldering, pin layout: Linear pinning, solder pin [P]: 3.5 mm

## Printed-circuit board connector - FRONT-MSTB 2,5/11-STF-5,08 - 1777882

### Accessories

---

#### Printed-circuit board connector - MSTBV 2,5/11-GF-5,08 - 1777167

PCB headers, nominal current: 12 A, rated voltage (III/2): 320 V, nominal cross section: 2.5 mm<sup>2</sup>, number of positions: 11, pitch: 5.08 mm, color: green, contact surface: Tin, mounting: Wave soldering, pin layout: Linear pinning, solder pin [P]: 3.9 mm



#### Feed-through header - MDSTB 2,5/11-GF-5,08 - 1842458

PCB headers, nominal current: 10 A, rated voltage (III/2): 320 V, nominal cross section: 2.5 mm<sup>2</sup>, number of positions: 11, pitch: 5.08 mm, color: green, contact surface: Tin, mounting: Wave soldering, pin layout: Linear pinning, solder pin [P]: 3.2 mm, The article can be aligned to create different nos. of positions! In combination with MVSTB or FKCV plug components, both an MVSTBW (or FKCVW) and an MVSTBR plug (or FKCVR) must be used. Combination with TMSTBP plug components is not possible!



#### Feed-through header - MDSTBV 2,5/11-GF-5,08 - 1845727

PCB headers, nominal current: 10 A, rated voltage (III/2): 320 V, nominal cross section: 2.5 mm<sup>2</sup>, number of positions: 11, pitch: 5.08 mm, color: green, contact surface: Tin, mounting: Wave soldering, pin layout: Linear pinning, solder pin [P]: 3.9 mm, The article can be aligned to create different nos. of positions! In combination with MVSTB or FKCV plug components, both an MVSTBW (or FKCVW) and an MVSTBR plug (or FKCVR) must be used. Combination with TMSTBP plug components is not possible!



#### Printed-circuit board connector - DFK-MSTBA 2,5/11-GF-5,08 - 1899074



Feed-through header, nominal current: 12 A, rated voltage (III/2): 320 V, nominal cross section: 2.5 mm<sup>2</sup>, number of positions: 11, pitch: 5.08 mm, color: green, contact surface: Tin, mounting: Wave soldering, pin layout: Linear pinning, solder pin [P]: 3.2 mm

#### Printed-circuit board connector - DFK-MSTBVA 2,5/11-GF-5,08 - 1899375



Feed-through header, nominal current: 12 A, rated voltage (III/2): 320 V, nominal cross section: 2.5 mm<sup>2</sup>, number of positions: 11, pitch: 5.08 mm, color: green, contact surface: Tin, mounting: Wave soldering, pin layout: Linear pinning, solder pin [P]: 3.9 mm

---

## Printed-circuit board connector - FRONT-MSTB 2,5/11-STF-5,08 - 1777882

### Accessories

#### Printed-circuit board connector - CC 2,5/11-GF-5,08 P26THR - 1954786

PCB headers, nominal current: 12 A, rated voltage (III/2): 320 V, nominal cross section: 2.5 mm<sup>2</sup>, number of positions: 11, pitch: 5.08 mm, color: black, contact surface: Tin, mounting: THR soldering, pin layout: Linear pinning, solder pin [P]: 2.6 mm, User information and design recommendations for through hole reflow technology can be found under: Downloads



#### Printed-circuit board connector - CC 2,5/11-GF-5,08 P26THRR88 - 1954896

PCB headers, nominal current: 12 A, rated voltage (III/2): 320 V, nominal cross section: 2.5 mm<sup>2</sup>, number of positions: 11, pitch: 5.08 mm, color: black, contact surface: Tin, mounting: THR soldering, pin layout: Linear pinning, solder pin [P]: 2.6 mm, User information and design recommendations for through hole reflow technology can be found under: Downloads



#### Printed-circuit board connector - CCV 2,5/11-GF-5,08 P26THR - 1955727

PCB headers, nominal current: 12 A, rated voltage (III/2): 320 V, nominal cross section: 2.5 mm<sup>2</sup>, number of positions: 11, pitch: 5.08 mm, color: black, contact surface: Tin, mounting: THR soldering, pin layout: Linear pinning, solder pin [P]: 2.6 mm, User information and design recommendations for through hole reflow technology can be found under: Downloads



#### Printed-circuit board connector - CCV 2,5/11-GF-5,08 P26THRR88 - 1955837

PCB headers, nominal current: 12 A, rated voltage (III/2): 320 V, nominal cross section: 2.5 mm<sup>2</sup>, number of positions: 11, pitch: 5.08 mm, color: black, contact surface: Tin, mounting: THR soldering, pin layout: Linear pinning, solder pin [P]: 2.6 mm, User information and design recommendations for through hole reflow technology can be found under: Downloads



Phoenix Contact 2020 © - all rights reserved  
<http://www.phoenixcontact.com>

PHOENIX CONTACT GmbH & Co. KG  
Flachsmarktstr. 8  
32825 Blomberg  
Germany  
Tel. +49 5235 300  
Fax +49 5235 3 41200  
<http://www.phoenixcontact.com>



## X-ON Electronics

Largest Supplier of Electrical and Electronic Components

*Click to view similar products for [Pluggable Terminal Blocks](#) category:*

*Click to view products by [Phoenix Contact](#) manufacturer:*

Other Similar products are found below :

[57.510.0053](#) [MC 1.5/ 6-ST-3.5 GY AU](#) [ET02015000J0G](#) [734-104](#) [734-302](#) [8-141-P](#) [8426620000](#) [860505](#) [860516](#) [860810](#) [GBPACX-12](#)  
[93.731.4953.0](#) [PV05-5,08-K](#) [PVP02-5,00](#) [PVP03-3,50](#) [PVP04-3,50](#) [PVS02-5,00](#) [1-1986160-3](#) [1377680000](#) [1531000000](#) [1546228-5](#)  
[ELFH16150](#) [ELFP03110](#) [ELFP10210](#) [ELFT06250](#) [ELVP03100](#) [1700101](#) [1700410](#) [1700425](#) [1702246](#) [1705229](#) [1710175](#) [1714537](#) [1717806](#)  
[1719600](#) [1728941](#) [1734692](#) [1734795](#) [1736036](#) [1740194](#) [1740291](#) [1740628](#) [1740990](#) [1746952](#) [1750207](#) [1752441](#) [1752865](#) [1754115](#)  
[1754144](#) [1756913](#)