

Feed-through header - PTSM 0,5/ 8-HH-2,5-THR R44 - 1778683

Please be informed that the data shown in this PDF Document is generated from our Online Catalog. Please find the complete data in the user's documentation. Our General Terms of Use for Downloads are valid (<http://phoenixcontact.com/download>)



PCB headers, nominal current: 6 A, rated voltage (III/2): 160 V, nominal cross section: 0.5 mm², number of positions: 8, pitch: 2.5 mm, color: black, contact surface: Tin, mounting: THR soldering, pin layout: Linear pinning, solder pin [P]: 2.1 mm

The figure shows the 3-pos. version

Your advantages

- Designed for integration into the SMT soldering process
- Supplied in tape-on-reel packing according to IEC 60286-3 for automated mounting



Key Commercial Data

Packing unit	500 pc
Minimum order quantity	500 pc
GTIN	
GTIN	4046356529860

Technical data

Dimensions

Length [l]	7.5 mm
Width	21.7 mm
Pitch	2.5 mm
Dimension a	17.5 mm
Width [w]	21.7 mm
Height [h]	7 mm
Installed height	5 mm
Length of the solder pin	2.1 mm
Pin dimensions	0.6 x 0.6 mm
Pin spacing	2.50 mm
Length	7.5 mm

General

Feed-through header - PTSM 0,5/ 8-HH-2,5-THR R44 - 1778683

Technical data

General

Range of articles	PTSM 0,5/..-HH-THR
Insulating material group	IIIa
Rated surge voltage (III/3)	2.5 kV
Rated surge voltage (III/2)	2.5 kV
Rated surge voltage (II/2)	2.5 kV
Rated voltage (III/3)	50 V
Rated voltage (III/2)	160 V
Rated voltage (II/2)	160 V
Connection in acc. with standard	EN-VDE
Nominal current I_N	6 A
Maximum load current	6 A
Insulating material	LCP
Flammability rating according to UL 94	V0
Color	black
Number of positions	8

Standards and Regulations

Connection in acc. with standard	EN-VDE
	UL
Flammability rating according to UL 94	V0

Environmental Product Compliance

China RoHS	Environmentally friendly use period: unlimited = EFUP-e
	No hazardous substances above threshold values

Drawings

Feed-through header - PTSM 0,5/ 8-HH-2,5-THR R44 - 1778683

Drilling diagram

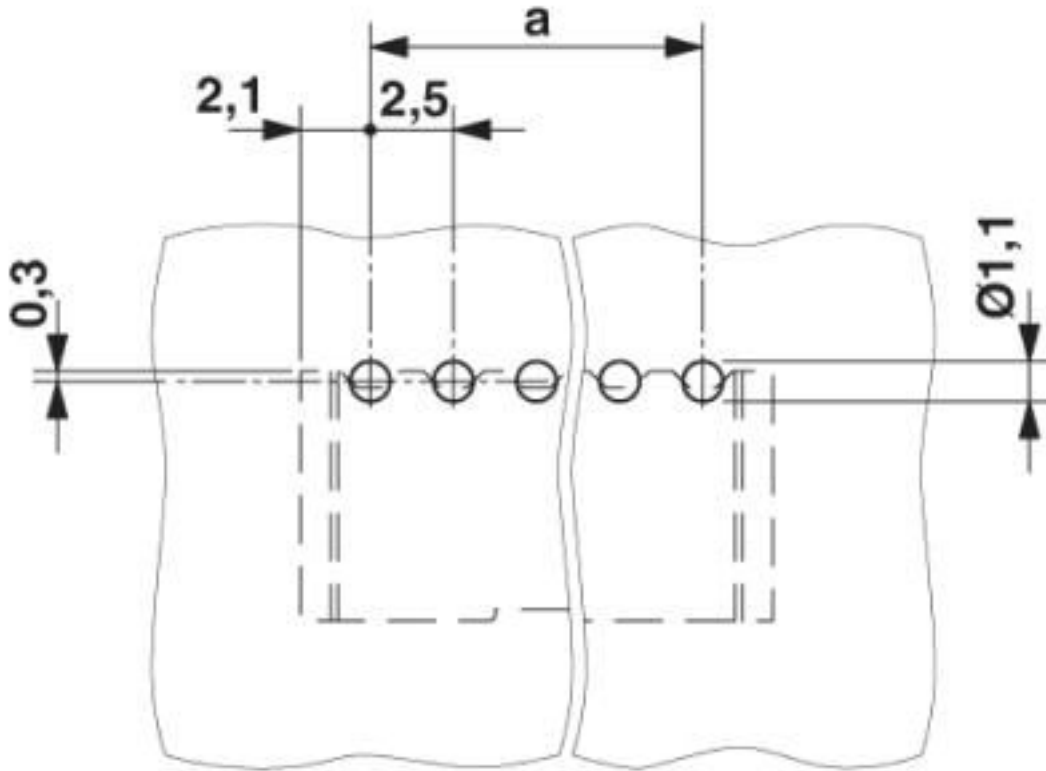

Diagram

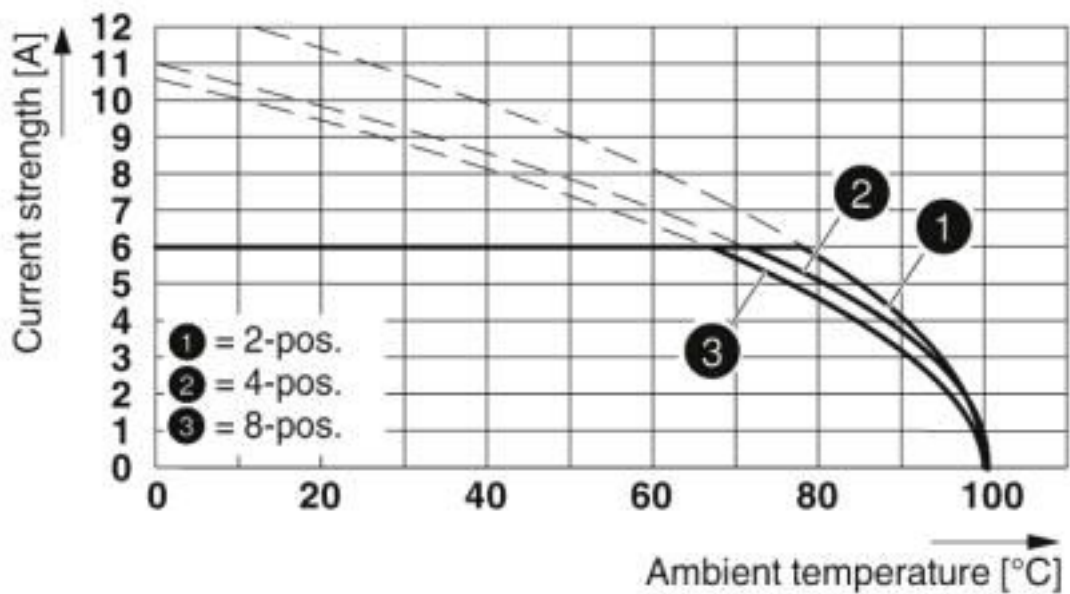

Derating curve for: PTSM 0,5/...-P-2,5 with PTSM 0,5/...-HH-2,5-THR R..

Feed-through header - PTSM 0,5/ 8-HH-2,5-THR R44 - 1778683

Diagram

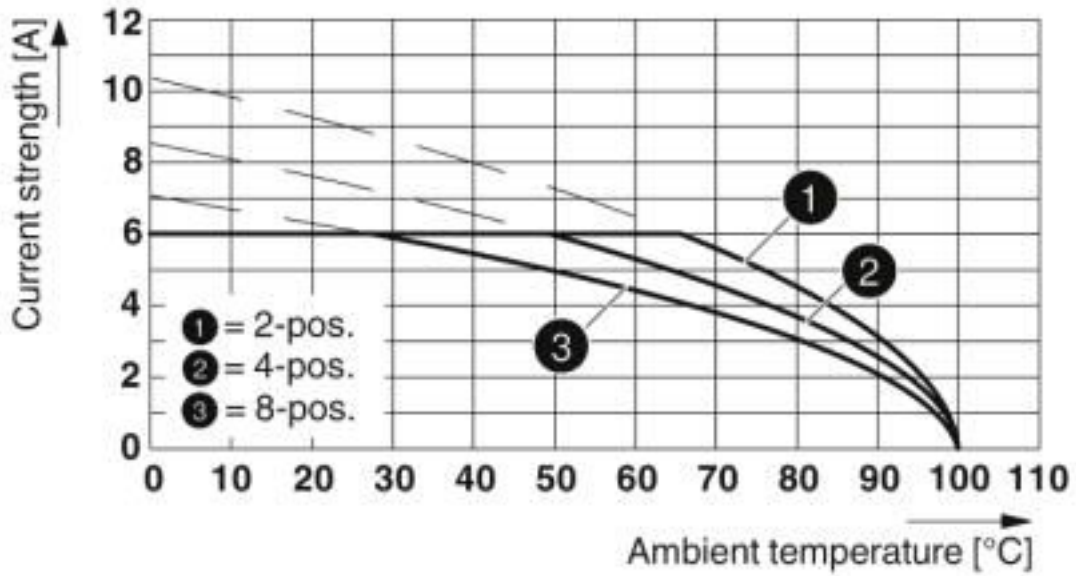

Type: PTSM 0,5/...-HH1-2,5-THR R... with PTSM 0,5/...-HH-2,5-THR R...

Diagram

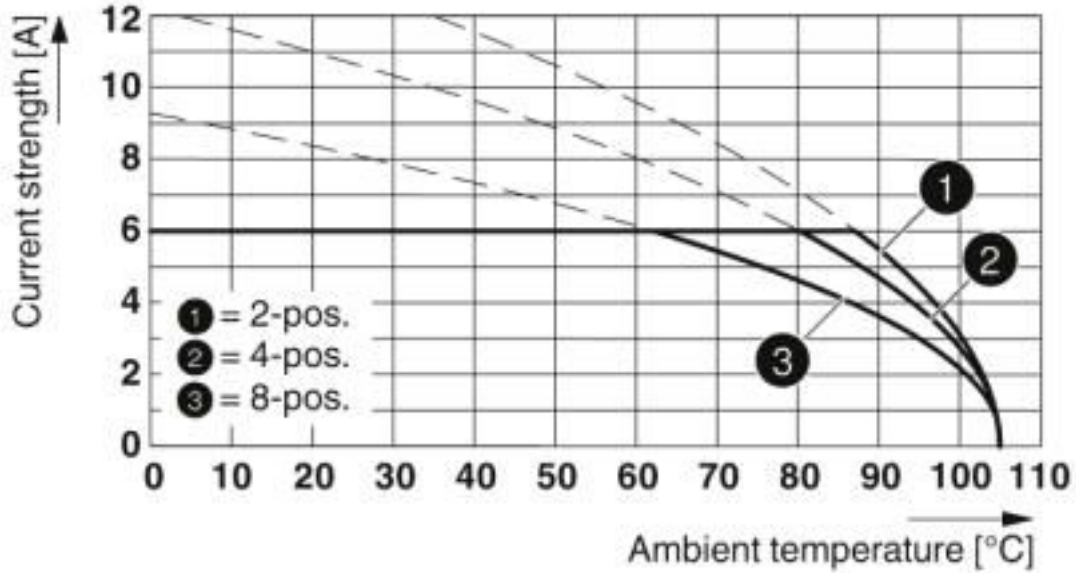

Type: PTCM 0,5/...-PL-2,5 WH with PTSM 0,5/...-HH-2,5-THR WH R...

Feed-through header - PTSM 0,5/ 8-HH-2,5-THR R44 - 1778683

Dimensional drawing

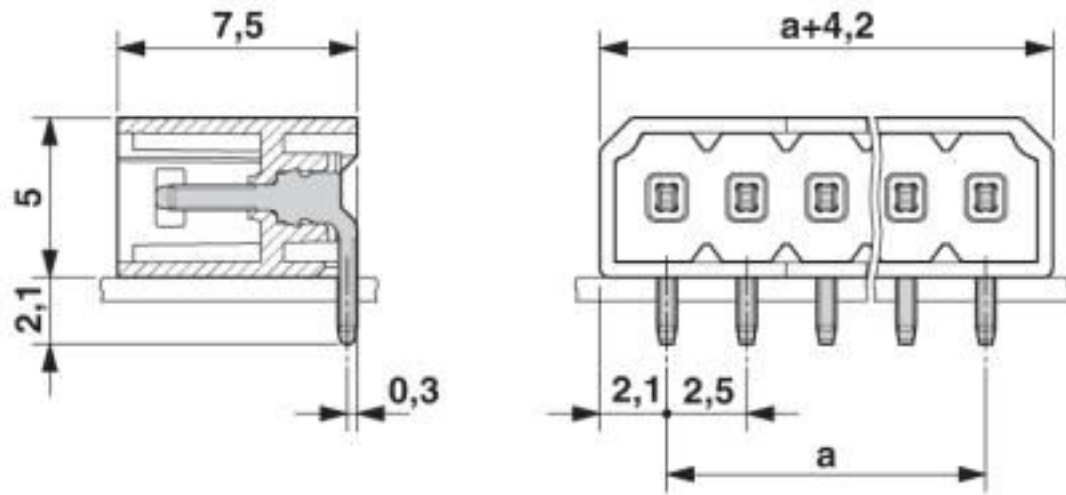

Feed-through header - PTSM 0,5/ 8-HH-2,5-THR R44 - 1778683

Dimensional drawing

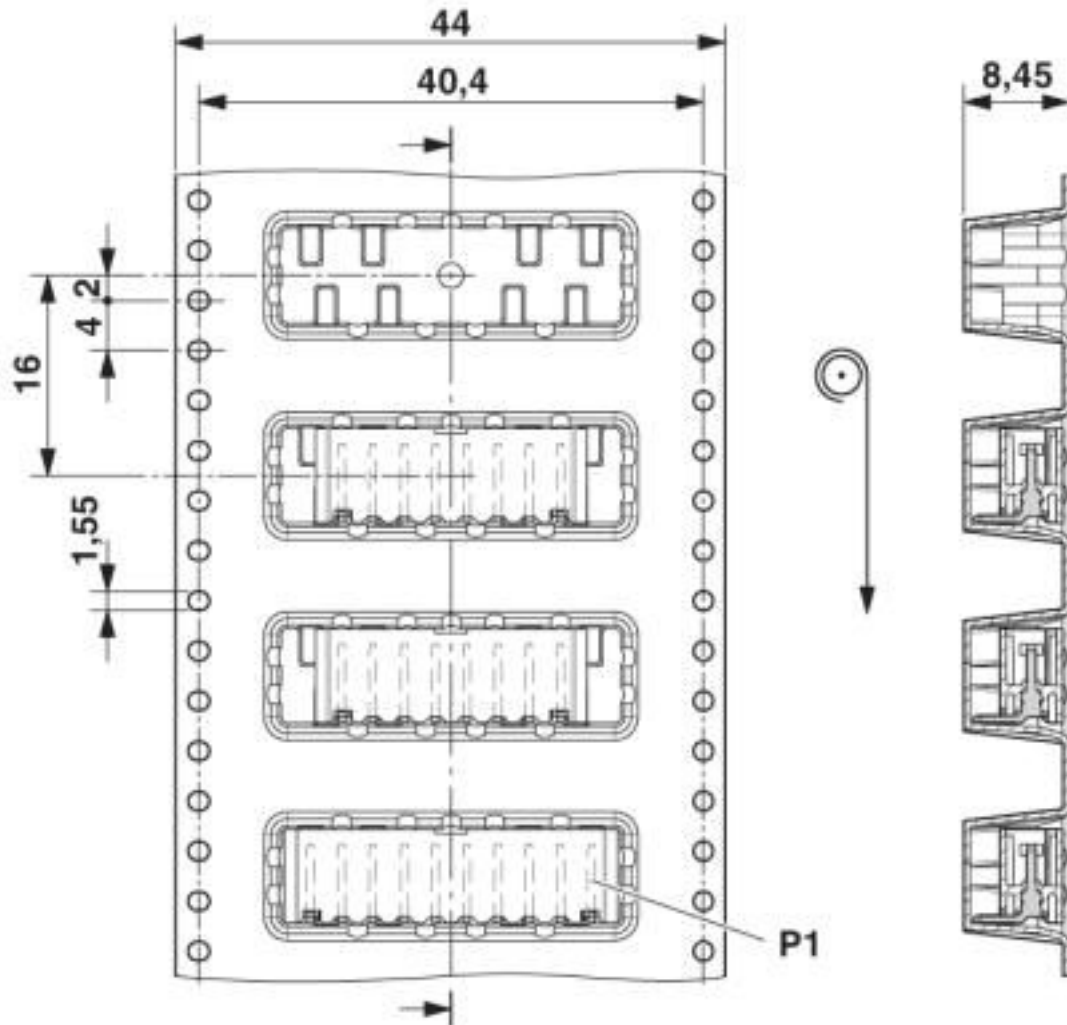

Classifications

eCl@ss

eCl@ss 10.0.1	27440402
eCl@ss 4.0	27260700
eCl@ss 4.1	27260700
eCl@ss 5.0	27260700
eCl@ss 5.1	27260700
eCl@ss 6.0	27260700
eCl@ss 7.0	27440402
eCl@ss 8.0	27440402
eCl@ss 9.0	27440402

Feed-through header - PTSM 0,5/ 8-HH-2,5-THR R44 - 1778683

Classifications

ETIM

ETIM 3.0	EC001121
ETIM 4.0	EC002637
ETIM 5.0	EC002637
ETIM 6.0	EC002637
ETIM 7.0	EC002637

UNSPSC

UNSPSC 6.01	30211810
UNSPSC 7.0901	39121409
UNSPSC 11	39121409
UNSPSC 12.01	39121409
UNSPSC 13.2	39121409
UNSPSC 18.0	39121409
UNSPSC 19.0	39121409
UNSPSC 20.0	39121409
UNSPSC 21.0	39121409

Approvals

Approvals

Approvals

UL Recognized / VDE Zeichengenehmigung / EAC / cULus Recognized

Ex Approvals

Approval details

UL Recognized		http://database.ul.com/cgi-bin/XYV/template/LISEXT/1FRAME/index.htm E118976-20130619
		B
Nominal voltage UN		150 V
Nominal current IN		5 A

VDE Zeichengenehmigung		http://www2.vde.com/de/Institut/Online-Service/VDE-gepruefteProdukte/Seiten/Online-Suche.aspx	40048497
Nominal voltage UN		160 V	

Feed-through header - PTSM 0,5/ 8-HH-2,5-THR R44 - 1778683

Approvals

Nominal current I _N	6 A
mm ² /AWG/kcmil	0.14-.5

EAC		B.01687
-----	--	---------

cULus Recognized		http://database.ul.com/cgi-bin/XYV/template/LISEXT/1FRAME/index.htm	E60425-20110108
Nominal voltage U _N		B	
Nominal current I _N		150 V	
		6 A	

Accessories

Additional products

Printed-circuit board connector - PTSM 0,5/ 8-P-2,5 - 1778890



PCB connector, nominal current: 6 A, rated voltage (III/2): 160 V, nominal cross section: 0.5 mm², number of positions: 8, pitch: 2.5 mm, connection method: Push-in spring connection, color: black, contact surface: Tin

Plug - PTPM 0,2/ 8-P-2,5 - 1780503



PCB connector, number of positions: 8, pitch: 2.5 mm, color: black, contact surface: Tin

Plug - PTPM 0,4/ 8-P-2,5 - 1780558



PCB connector, number of positions: 8, pitch: 2.5 mm, color: black, contact surface: Tin

Phoenix Contact 2020 © - all rights reserved
<http://www.phoenixcontact.com>

PHOENIX CONTACT GmbH & Co. KG
Flachsmarktstr. 8
32825 Blomberg
Germany
Tel. +49 5235 300
Fax +49 5235 3 41200
<http://www.phoenixcontact.com>

X-ON Electronics

Largest Supplier of Electrical and Electronic Components

Click to view similar products for [Pluggable Terminal Blocks](#) category:

Click to view products by [Phoenix Contact](#) manufacturer:

Other Similar products are found below :

[57.510.0053](#) [MC 1.5/ 6-ST-3.5 GY AU](#) [734-104](#) [734-302](#) [8-141-P](#) [8426620000](#) [860505](#) [860516](#) [860810](#) [GBPACX-12](#) [93.731.4953.0](#) [PV05-5,08-K](#) [PVP02-5,00](#) [PVP03-3,50](#) [PVP04-3,50](#) [PVS02-5,00](#) [1-1986160-3](#) [1377680000](#) [1531000000](#) [1546228-5](#) [ELFH16150](#) [ELFP03110](#) [ELFP10210](#) [ELFT06250](#) [ELVP03100](#) [1700101](#) [1700410](#) [1700425](#) [1702246](#) [1705229](#) [1710175](#) [1714537](#) [1717806](#) [1719600](#) [1728941](#) [1734692](#) [1734795](#) [1736036](#) [1740194](#) [1740291](#) [1740628](#) [1740990](#) [1746952](#) [1750207](#) [1752441](#) [1752865](#) [1754115](#) [1754144](#) [1756913](#) [1760051](#)