

## Feed-through header - ICV 2,5/ 6-G-5,08 - 1785984

Please be informed that the data shown in this PDF Document is generated from our Online Catalog. Please find the complete data in the user's documentation. Our General Terms of Use for Downloads are valid (<http://phoenixcontact.com/download>)

PCB headers, nominal current: 12 A, rated voltage (III/2): 320 V, nominal cross section: 2.5 mm<sup>2</sup>, number of positions: 6, pitch: 5.08 mm, color: green, contact surface: Tin, mounting: Wave soldering, pin layout: Linear pinning, solder pin [P]: 3.5 mm



The figure shows a 10-position version of the product

### Your advantages

- ✓ Maximum flexibility when it comes to device design – one header for connectors with different connection technologies
- ✓ Easy PCB replacement thanks to plug-in modules
- ✓ Well-known mounting principle allows worldwide use
- ✓ Inverted header with socket contacts for touch-proof device outputs or PCB/PCB connections



### Key Commercial Data

Packing unit	50 pc
GTIN	 4 017918 042134
GTIN	4017918042134

### Technical data

#### Item properties

Brief article description	Feed-through header
Plug-in system	CLASSIC COMBICON
Type of contact	Female connector
Range of articles	ICV 2,5/..-G
Pitch	5.08 mm
Number of positions	6
Mounting type	Wave soldering
Pin layout	Linear pinning
Locking	without
Number of levels	1
Number of connections	6

# Feed-through header - ICV 2,5/ 6-G-5,08 - 1785984

## Technical data

### Item properties

Number of potentials	6
----------------------	---

### Electrical parameters

Nominal current	12 A
Nom. voltage	320 V
Rated voltage	320 V
Rated voltage (III/2)	320 V
Rated voltage (II/2)	630 V
Rated surge voltage (III/3)	4 kV
Rated surge voltage (III/2)	4 kV
Rated surge voltage (II/2)	4 kV

### Material data - contact

Note	WEEE/RoHS-compliant, free of whiskers according to IEC 60068-2-82/ JEDEC JESD 201
Contact material	Cu alloy
Surface characteristics	Tin-plated
Metal surface contact area (top layer)	Tin (4 - 8 µm Sn)
Metal surface soldering area (top layer)	Tin (4 - 8 µm Sn)

### Material data - housing

Housing color	green (6021)
Insulating material	PA
Insulating material group	I
CTI according to IEC 60112	600
Flammability rating according to UL 94	V0
Glow wire flammability index GWFI according to EN 60695-2-12	850
Glow wire ignition temperature GWIT according to EN 60695-2-13	775
Temperature for the ball pressure test according to EN 60695-10-2	125 °C

### Dimensions for the product

Length [ l ]	10.2 mm
Width [ w ]	32.48 mm
Height [ h ]	22.4 mm
Pitch	5.08 mm
Height (without solder pin)	18.9 mm
Solder pin [P]	3.5 mm
Pin spacing	5.08 mm
Pin dimensions	0.47 x 1.15 mm

### Dimensions for PCB design

Hole diameter	1.4 mm
Pin spacing	5.08 mm

# Feed-through header - ICV 2,5/ 6-G-5,08 - 1785984

## Technical data

### Packaging information

Type of packaging	packed in cardboard
Pieces per package	50
Denomination packing units	Pcs.

### Ambient conditions

Ambient temperature (storage/transport)	-40 °C ... 70 °C
Ambient temperature (assembly)	-5 °C ... 100 °C
Ambient temperature (operation)	-40 °C ... 100 °C (dependent on the derating curve)

### Air clearances and creepage distances

Clearances and creepage distances	IEC 60664-1:2007-04
Specification	IEC 60664-1:2007-04
Minimum clearance - inhomogeneous field (III/3)	3 mm
Minimum clearance - inhomogeneous field (III/2)	3 mm
Minimum clearance - inhomogeneous field (II/2)	3 mm
Minimum creepage distance value (III/3)	4 mm
Minimum creepage distance value (III/2)	3 mm
Minimum creepage distance value (II/2)	3.2 mm

### Mechanical tests (A)

Test specification	IEC 61984
Insertion strength per pos. approx.	8 N
Withdraw strength per pos. approx.	6 N
Polarization when inserted requirement >20 N	Test passed
Contact holder in insert requirements >20 N	Test passed

### Durability tests (B)

Specification	IEC 60512-9-1:2010-03
Contact resistance R <sub>1</sub>	1.5 mΩ
Insertion/withdrawal cycles	25
Contact resistance R <sub>2</sub>	1.5 mΩ
Impulse withstand voltage at sea level	4.8 kV
Power-frequency withstand voltage	2.21 kV
Insulation resistance, neighboring positions	> 0.3 TΩ

### Thermal tests (C)

Specification	IEC 60512-5-1:2002-02
Number of positions	16
Conductor cross section	2.5 mm <sup>2</sup>
Test current	12 A
Upper limiting temperature requirements <100 °C	Test passed

### Climatic tests (D)

Specification	ISO 6988:1985-02
---------------	------------------

## Feed-through header - ICV 2,5/ 6-G-5,08 - 1785984

### Technical data

#### Climatic tests (D)

Cold stress	-40 °C/2 h
Thermal stress	100 °C/168 h
Corrosive stress	0.2 dm <sup>3</sup> SO <sub>2</sub> on 300 dm <sup>3</sup> /40 °C/1 cycle
Impulse withstand voltage at sea level	4.8 kV
Power-frequency withstand voltage	2.21 kV

#### Environmental and durability tests (E)

Specification	IEC 61984:2008-10
Result, degree of protection, IP code	Finger safety with IP20 test finger

#### Vibration test

Specification	IEC 60068-2-6:2007-12
Result	Test passed
Frequency	10 - 150 - 10 Hz
Sweep speed	1 octave/min
Amplitude	0.35 mm (10 - 60.1 Hz)
Acceleration	5 g (60.1 - 150 Hz)
Test duration per axis	2.5 h

#### Standards and Regulations

Connection in acc. with standard	EN-VDE
	CSA
Flammability rating according to UL 94	V0

#### Environmental Product Compliance

China RoHS	Environmentally friendly use period: unlimited = EFUP-e
	No hazardous substances above threshold values

### Drawings

# Feed-through header - ICV 2,5/ 6-G-5,08 - 1785984

Drilling diagram

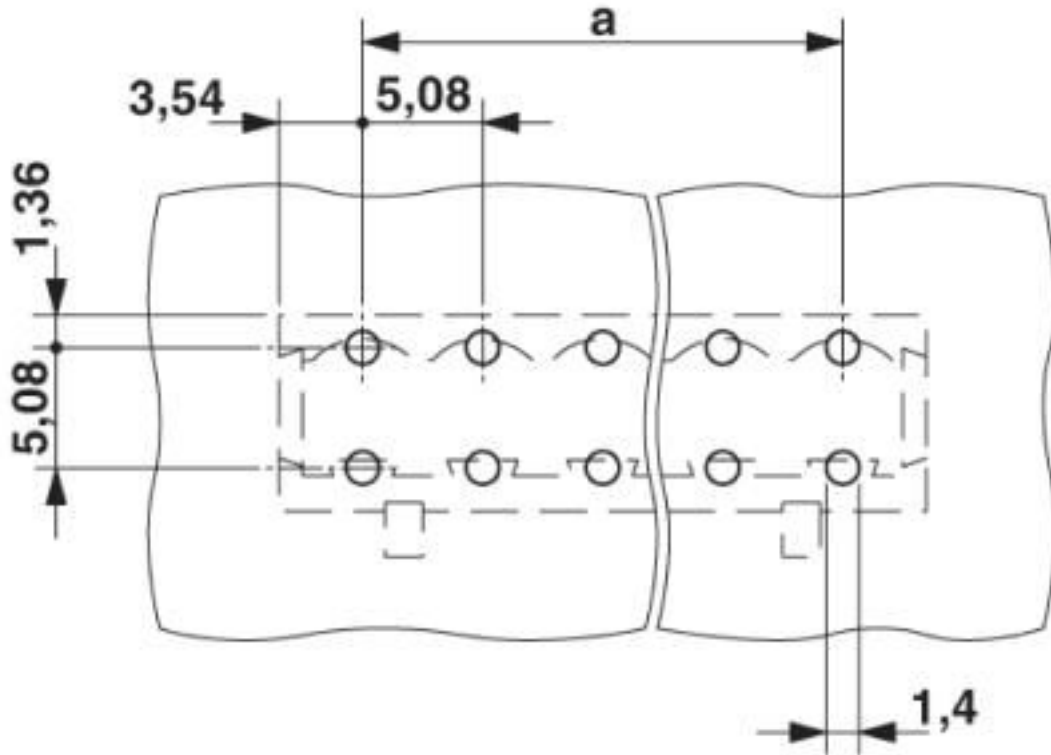

Diagram

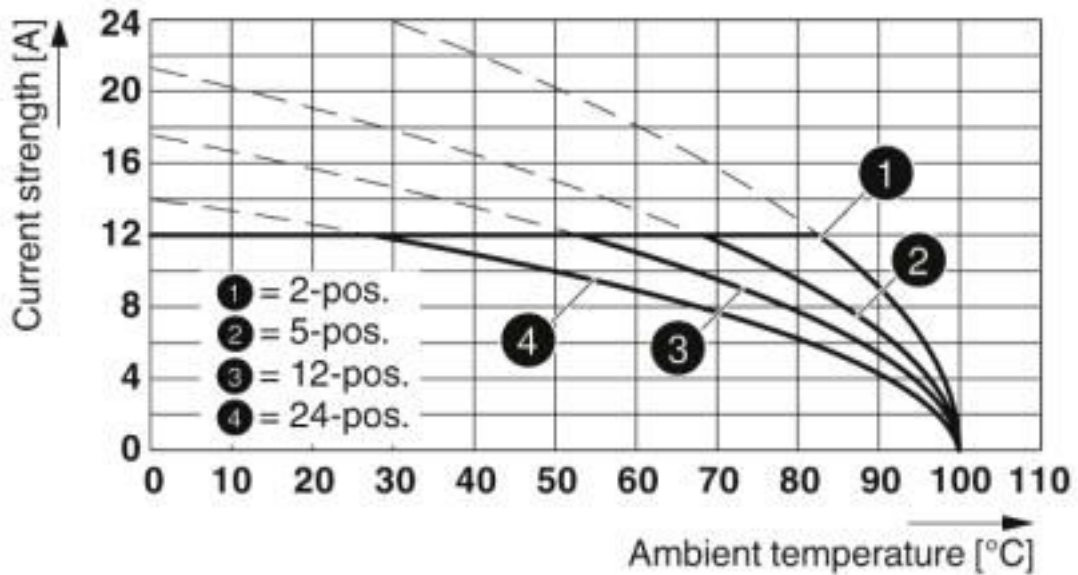

Type: ICV 2,5/...-G-5,08 with MSTBA 2,5/...-G-5,08

# Feed-through header - ICV 2,5/ 6-G-5,08 - 1785984

Dimensional drawing

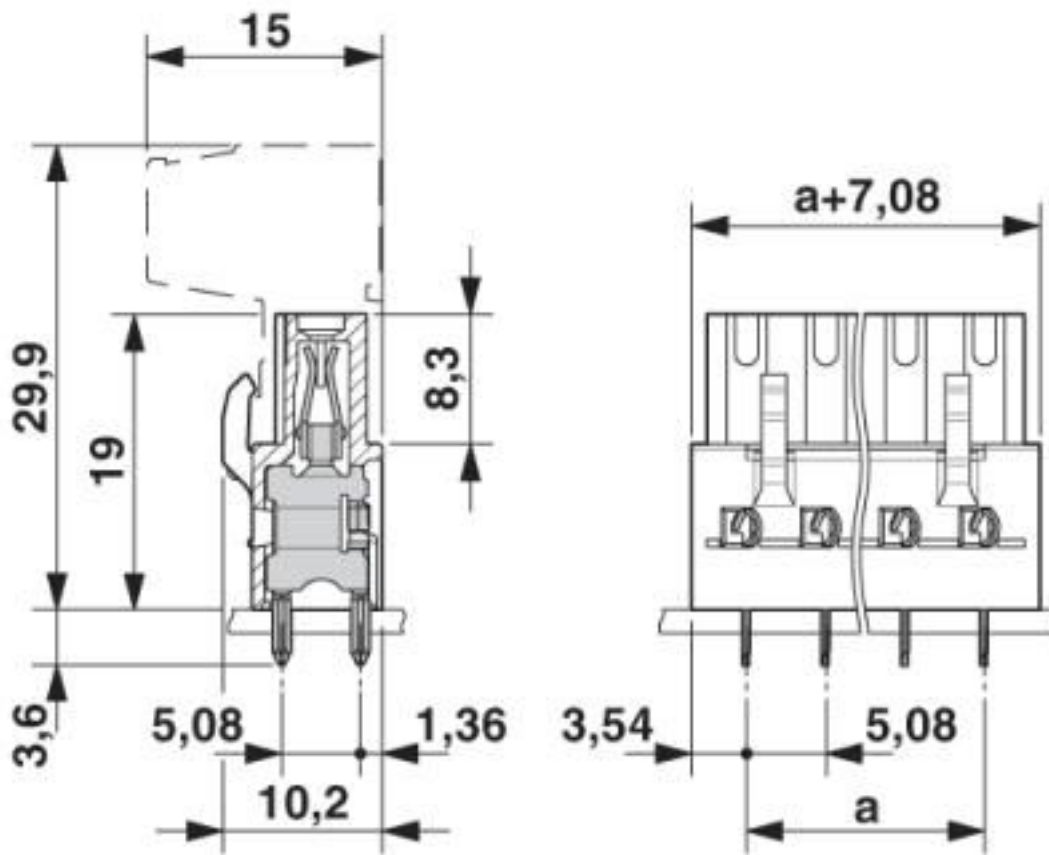

## Classifications

eCl@ss

eCl@ss 10.0.1	27440402
eCl@ss 4.0	27260700
eCl@ss 4.1	27260700
eCl@ss 5.0	27260700
eCl@ss 5.1	27260700
eCl@ss 6.0	27260700
eCl@ss 7.0	27440402
eCl@ss 8.0	27440402
eCl@ss 9.0	27440402

ETIM

ETIM 3.0	EC001121
ETIM 4.0	EC002637
ETIM 5.0	EC002637
ETIM 6.0	EC002637
ETIM 7.0	EC002637

# Feed-through header - ICV 2,5/ 6-G-5,08 - 1785984

## Classifications

### UNSPSC

UNSPSC 6.01	30211810
UNSPSC 7.0901	39121409
UNSPSC 11	39121409
UNSPSC 12.01	39121409
UNSPSC 13.2	39121409
UNSPSC 18.0	39121409
UNSPSC 19.0	39121409
UNSPSC 20.0	39121409
UNSPSC 21.0	39121409

## Approvals

### Approvals

#### Approvals

CSA / IEC/IEE CB Scheme / EAC / cULus Recognized / VDE Zeichengenehmigung

#### Ex Approvals

### Approval details

CSA		<a href="http://www.csagroup.org/services-industries/product-listing/">http://www.csagroup.org/services-industries/product-listing/</a>	13631
		B	D
Nominal voltage UN		300 V	300 V
Nominal current IN		10 A	10 A

IECEE CB Scheme		<a href="http://www.iecee.org/">http://www.iecee.org/</a>	DE1-60988-B1B2
Nominal voltage UN		250 V	
Nominal current IN		12 A	

EAC		B.01687
-----	---	---------

# Feed-through header - ICV 2,5/ 6-G-5,08 - 1785984

## Approvals

cULus Recognized		<a href="http://database.ul.com/cgi-bin/XYV/template/LISEXT/1FRAME/index.htm">http://database.ul.com/cgi-bin/XYV/template/LISEXT/1FRAME/index.htm</a>	E60425-19931014
	B	D	
Nominal voltage UN	250 V	300 V	
Nominal current IN	12 A	10 A	

VDE Zeichengenehmigung		<a href="http://www2.vde.com/de/Institut/Online-Service/VDE-gepruefteProdukte/Seiten/Online-Suche.aspx">http://www2.vde.com/de/Institut/Online-Service/VDE-gepruefteProdukte/Seiten/Online-Suche.aspx</a>	40050648
Nominal voltage UN	250 V		
Nominal current IN	12 A		

## Accessories

### Accessories

#### Coding element

Coding profile - CP-MSTB - 1734634

Coding profile, is inserted into the slot on the plug or inverted header, red insulating material



#### Test plug terminal block

Test plugs - MPS-MT - 0201744



Test plugs, with solder connection up to 1 mm<sup>2</sup> conductor cross section, color: gray

Reducing plug - RPS - 0201647



Reducing plug, color: gray



## Feed-through header - ICV 2,5/ 6-G-5,08 - 1785984

### Accessories

Mounting material - FLRP/ICV 80 - 1808353



Pair of guide rails, is inserted into the groove ICV/...G, height: 86 mm, hole diameter: 3.4 mm

---

### Additional products

Printed-circuit board connector - DFK-MSTBA 2,5/ 6-G-5,08 - 1898871



Feed-through header, nominal current: 12 A, rated voltage (III/2): 320 V, nominal cross section: 2.5 mm<sup>2</sup>, number of positions: 6, pitch: 5.08 mm, color: green, contact surface: Tin, mounting: Wave soldering, pin layout: Linear pinning, solder pin [P]: 3.2 mm

---

Feed-through header - MSTBO 2,5/ 6-GL-5,08 - 1850479



PCB headers, nominal current: 8 A, rated voltage (III/2): 320 V, nominal cross section: 2.5 mm<sup>2</sup>, number of positions: 6, pitch: 5.08 mm, color: green, contact surface: Tin, mounting: Wave soldering, pin layout: Linear pinning, solder pin [P]: 3.2 mm

---

Feed-through header - MSTBO 2,5/ 6-GR-5,08 - 1847149



PCB headers, nominal current: 8 A, rated voltage (III/2): 320 V, nominal cross section: 2.5 mm<sup>2</sup>, number of positions: 6, pitch: 5.08 mm, color: green, contact surface: Tin, mounting: Wave soldering, pin layout: Linear pinning, solder pin [P]: 3.2 mm

---

Feed-through header - A-MSTBVA 2,5/ 6-G-5,08 - 1872509



PCB headers, nominal current: 12 A, rated voltage (III/2): 320 V, nominal cross section: 2.5 mm<sup>2</sup>, number of positions: 6, pitch: 5.08 mm, color: green, contact surface: Tin, mounting: DIN rail, pin layout: Linear pinning, solder pin [P]: 16.2 mm

## Feed-through header - ICV 2,5/ 6-G-5,08 - 1785984

### Accessories

#### Printed-circuit board connector - IC 2,5/ 6-ST-5,08 - 1786213



PCB connector, nominal current: 12 A, rated voltage (III/2): 320 V, nominal cross section: 2.5 mm<sup>2</sup>, number of positions: 6, pitch: 5.08 mm, connection method: Screw connection with tension sleeve, color: green, contact surface: Tin

#### Feed-through header - MSTBW 2,5/ 6-G-5,08 - 1735840



PCB headers, nominal current: 12 A, rated voltage (III/2): 320 V, nominal cross section: 2.5 mm<sup>2</sup>, number of positions: 6, pitch: 5.08 mm, color: green, contact surface: Tin, mounting: Wave soldering, pin layout: Linear pinning, solder pin [P]: 3.5 mm

#### Printed-circuit board connector - MSTBVA 2,5/ 6-G-5,08 - 1755778



PCB headers, nominal current: 12 A, rated voltage (III/2): 320 V, nominal cross section: 2.5 mm<sup>2</sup>, number of positions: 6, pitch: 5.08 mm, color: green, contact surface: Tin, mounting: Wave soldering, pin layout: Linear pinning, solder pin [P]: 3.9 mm

#### Feed-through header - MSTBV 2,5/ 6-G-5,08 - 1758050



PCB headers, nominal current: 12 A, rated voltage (III/2): 320 V, nominal cross section: 2.5 mm<sup>2</sup>, number of positions: 6, pitch: 5.08 mm, color: green, contact surface: Tin, mounting: Wave soldering, pin layout: Linear pinning, solder pin [P]: 3.9 mm

#### Feed-through header - MSTB 2,5/ 6-G-5,08 - 1759059



PCB headers, nominal current: 12 A, rated voltage (III/2): 320 V, nominal cross section: 2.5 mm<sup>2</sup>, number of positions: 6, pitch: 5.08 mm, color: green, contact surface: Tin, mounting: Wave soldering, pin layout: Linear pinning, solder pin [P]: 3.5 mm

## Feed-through header - ICV 2,5/ 6-G-5,08 - 1785984

### Accessories

Printed-circuit board connector - DFK-MSTBVA 2,5/ 6-G-5,08 - 1899171



Feed-through header, nominal current: 12 A, rated voltage (III/2): 320 V, nominal cross section: 2.5 mm<sup>2</sup>, number of positions: 6, pitch: 5.08 mm, color: green, contact surface: Tin, mounting: Wave soldering, pin layout: Linear pinning

Feed-through header - MDSTBVA 2,5/ 6-G-5,08 - 1845374



PCB headers, nominal current: 10 A, rated voltage (III/2): 320 V, nominal cross section: 2.5 mm<sup>2</sup>, number of positions: 6, pitch: 5.08 mm, color: green, contact surface: Tin, mounting: Wave soldering, pin layout: Linear pinning, solder pin [P]: 3.9 mm, The article can be aligned to create different nos. of positions! In combination with MVSTB or FKCV plug components, both an MVSTBW (or FKCVW) and an MVSTBR plug (or FKCVR) must be used. Combination with TMSTBP plug components is not possible!

Feed-through header - MDSTBA 2,5/ 6-G-5,08 - 1842102



PCB headers, nominal current: 10 A, rated voltage (III/2): 320 V, nominal cross section: 2.5 mm<sup>2</sup>, number of positions: 6, pitch: 5.08 mm, color: green, contact surface: Tin, mounting: Wave soldering, pin layout: Linear pinning, solder pin [P]: 3.2 mm, The article can be aligned to create different nos. of positions! In combination with MVSTB or FKCV plug components, both an MVSTBW (or FKCVW) and an MVSTBR plug (or FKCVR) must be used. Combination with TMSTBP plug components is not possible!

Feed-through header - EMSTBVA 2,5/ 6-G-5,08 - 1859551



PCB headers, nominal current: 12 A, rated voltage (III/2): 320 V, nominal cross section: 2.5 mm<sup>2</sup>, number of positions: 6, pitch: 5.08 mm, color: green, contact surface: Tin, mounting: Press-in technology, pin layout: Linear pinning, solder pin [P]: 3.9 mm

Printed-circuit board connector - FKIC 2,5/ 6-ST-5,08 - 1873391



PCB connector, nominal current: 12 A, rated voltage (III/2): 320 V, nominal cross section: 2.5 mm<sup>2</sup>, number of positions: 6, pitch: 5.08 mm, connection method: Push-in spring connection, color: green, contact surface: Tin

## Feed-through header - ICV 2,5/ 6-G-5,08 - 1785984

### Accessories

#### Feed-through header - MSTBA 2,5/ 6-G-5,08-LA - 1770986



PCB headers, number of positions: 6, pitch: 5.08 mm, color: green, contact surface: Tin, pin layout: Linear pinning, solder pin [P]: 3.5 mm

---

#### Printed-circuit board connector - MSTBA 2,5/ 6-G-5,08 - 1757284



PCB headers, nominal current: 12 A, rated voltage (III/2): 320 V, nominal cross section: 2.5 mm<sup>2</sup>, number of positions: 6, pitch: 5.08 mm, color: green, contact surface: Tin, mounting: Wave soldering, pin layout: Linear pinning, solder pin [P]: 3.5 mm

---

#### Feed-through header - MSTB 2,5/ 6-G-5,08-LA - 1770753



PCB headers, number of positions: 6, pitch: 5.08 mm, color: green, contact surface: Tin, pin layout: Linear pinning, solder pin [P]: 3.2 mm

---

#### Feed-through header - MDSTBV 2,5/ 6-G1-5,08 - 1762541



PCB headers, nominal current: 10 A, rated voltage (III/2): 320 V, nominal cross section: 2.5 mm<sup>2</sup>, number of positions: 6, pitch: 5.08 mm, color: green, contact surface: Tin, mounting: Wave soldering, pin layout: Linear pinning, solder pin [P]: 3.9 mm, In combination with MVSTB or FKCV plug components, both an MVSTBW (or FKCVW) and an MVSTBR plug (or FKCVR) must be used. Combination with TMSTBP plug components is not possible!

---

#### Feed-through header - MDSTB 2,5/ 6-G1-5,08 - 1762415



PCB headers, nominal current: 10 A, rated voltage (III/2): 320 V, nominal cross section: 2.5 mm<sup>2</sup>, number of positions: 6, pitch: 5.08 mm, color: green, contact surface: Tin, mounting: Wave soldering, pin layout: Linear pinning, solder pin [P]: 3.5 mm, In combination with MVSTB or FKCV plug components, both an MVSTBW (or FKCVW) and an MVSTBR plug (or FKCVR) must be used. Combination with TMSTBP plug components is not possible!

## Feed-through header - ICV 2,5/ 6-G-5,08 - 1785984

### Accessories

#### Feed-through header - SMSTBA 2,5/ 6-G-5,08 - 1767410

PCB headers, nominal current: 12 A, rated voltage (III/2): 320 V, nominal cross section: 2.5 mm<sup>2</sup>, number of positions: 6, pitch: 5.08 mm, color: green, contact surface: Tin, mounting: Wave soldering, pin layout: Linear pinning, solder pin [P]: 3.5 mm



---

#### Printed-circuit board connector - SMSTB 2,5/ 6-G-5,08 - 1769502

PCB headers, nominal current: 12 A, rated voltage (III/2): 320 V, nominal cross section: 2.5 mm<sup>2</sup>, number of positions: 6, pitch: 5.08 mm, color: green, contact surface: Tin, mounting: Wave soldering, pin layout: Linear pinning, solder pin [P]: 3.5 mm



---

#### Printed-circuit board connector - ICC 2,5/ 6-STZ-5,08 - 1823888

PCB connector, nominal current: 12 A, rated voltage (III/2): 320 V, nominal cross section: 2.5 mm<sup>2</sup>, number of positions: 6, pitch: 5.08 mm, connection method: Crimp connection, color: green, Corresponding male crimp contacts with current [A] and conductor cross section range [mm<sup>2</sup>] data: 10A/ICC-MT 0,5-1,0 (3190577); 10A/ICC-MT 0,5-1,0 BA (3190603); 12A/ICC-MT 1,5-2,5 (3190580); 12A/ICC-MT 1,5-2,5 BA (3190593). BA = Bandkontakte



---

Phoenix Contact 2020 © - all rights reserved  
<http://www.phoenixcontact.com>

PHOENIX CONTACT GmbH & Co. KG  
Flachsmarktstr. 8  
32825 Blomberg  
Germany  
Tel. +49 5235 300  
Fax +49 5235 3 41200  
<http://www.phoenixcontact.com>

## X-ON Electronics

Largest Supplier of Electrical and Electronic Components

*Click to view similar products for [Pluggable Terminal Blocks](#) category:*

*Click to view products by [Phoenix Contact](#) manufacturer:*

Other Similar products are found below :

[57.510.0053](#) [MC 1.5/ 6-ST-3.5 GY AU](#) [734-104](#) [734-302](#) [8-141-P](#) [8426620000](#) [860505](#) [860810](#) [GBPACX-12](#) [93.731.4953.0](#) [PV05-5,08-K](#)  
[PVP02-5,00](#) [PVP03-3,50](#) [PVP04-3,50](#) [PVS02-5,00](#) [1-1986160-3](#) [1377680000](#) [1531000000](#) [1546228-5](#) [ELFH16150](#) [ELFP03110](#)  
[ELFP10210](#) [ELFT06250](#) [ELVP03100](#) [1700101](#) [1700410](#) [1700425](#) [1702246](#) [1705229](#) [1710175](#) [1714537](#) [1717806](#) [1719600](#) [1728941](#)  
[1734692](#) [1734795](#) [1736036](#) [1740194](#) [1740291](#) [1740628](#) [1740990](#) [1746952](#) [1750207](#) [1752441](#) [1752865](#) [1754115](#) [1754144](#) [1756913](#)  
[1760051](#) [1760336](#)