

## PCB terminal block - FFKDSA1/V-2,54- 6 - 1789579

Please be informed that the data shown in this PDF Document is generated from our Online Catalog. Please find the complete data in the user's documentation. Our General Terms of Use for Downloads are valid (<http://phoenixcontact.com/download>)



PCB terminal block, nominal current: 6 A, rated voltage (III/2): 160 V, nominal cross section: 0.5 mm<sup>2</sup>, pitch: 2.54 mm, number of positions: 6, connection method: Push-in spring connection, mounting: Wave soldering, conductor/PCB connection direction: 90 °, color: green, Pin layout: Linear double pinning, Solder pin [P]: 3.4 mm. The article can be aligned to create different nos. of positions!

The figure shows the 10-position version

### Your advantages

- Time saving push-in connection, tools not required
- Defined contact force ensures that contact remains stable over the long term
- Intuitive use through colour coded actuation lever
- Operation and conductor connection from one direction enable integration into front of device
- Two solder pins reduce the mechanical strain on the soldering spots
- The latching on the side enables various numbers of positions to be combined
- Vertical connection enables multi-row arrangement on the PCB



### Key Commercial Data

Packing unit	50 pc
GTIN	 4 017918 330309
GTIN	4017918330309

### Technical data

#### Item properties

Brief article description	PCB terminal block
Range of articles	FFKDS(A) 0,5/..-V
Pitch	2.54 mm
Number of positions	6
Connection method	Push-in spring connection
Mounting type	Wave soldering
Pin layout	Linear double pinning
Number of levels	1

# PCB terminal block - FFKDSA1/V-2,54- 6 - 1789579

## Technical data

### Item properties

Number of connections	6
Number of potentials	6

### Electrical parameters

Nominal current	6 A
Nom. voltage	160 V
Rated voltage	63 V
Rated voltage (III/2)	160 V
Rated voltage (II/2)	320 V
Rated surge voltage (III/3)	2.5 kV
Rated surge voltage (III/2)	2.5 kV
Rated surge voltage (II/2)	2.5 kV

### Connection capacity

Connection method	Push-in spring connection
pluggable	Yes
Conductor cross section solid	0.14 mm <sup>2</sup> ... 0.5 mm <sup>2</sup>
Conductor cross section flexible	0.14 mm <sup>2</sup> ... 0.5 mm <sup>2</sup>
Conductor cross section AWG / kcmil	26 ... 20
Stripping length	11 mm

### Material data - contact

Note	WEEE/RoHS-compliant, free of whiskers according to IEC 60068-2-82/ JEDEC JESD 201
Contact material	Cu alloy
Surface characteristics	Tin-plated
Metal surface terminal point (top layer)	Tin (5 - 7 µm Sn)
Metal surface terminal point (middle layer)	Nickel (2 - 3 µm Ni)
Metal surface soldering area (top layer)	Tin (5 - 7 µm Sn)
Metal surface soldering area (middle layer)	Nickel (2 - 3 µm Ni)

### Material data - housing

Housing color	green (6021)
Insulating material	PA
Insulating material group	I
CTI according to IEC 60112	600
Flammability rating according to UL 94	V0
Glow wire flammability index GWFI according to EN 60695-2-12	850
Glow wire ignition temperature GWIT according to EN 60695-2-13	775
Temperature for the ball pressure test according to EN 60695-10-2	125 °C

### Dimensions for the product

Length [ l ]	12.6 mm
Width [ w ]	17.74 mm

# PCB terminal block - FFKDSA1/V-2,54- 6 - 1789579

## Technical data

### Dimensions for the product

Height [ h ]	17 mm
Pitch	2.54 mm
Height (without solder pin)	13.6 mm
Solder pin [P]	3.4 mm
Pin spacing	5.08 mm
Pin dimensions	0.5 x 0.8 mm

### Dimensions for PCB design

Hole diameter	1.1 mm
Pin spacing	5.08 mm

### Packaging information

Type of packaging	packed in cardboard
Pieces per package	50
Denomination packing units	Pcs.

### Ambient conditions

Ambient temperature (storage/transport)	-40 °C ... 70 °C
Ambient temperature (assembly)	-5 °C ... 100 °C
Ambient temperature (operation)	-40 °C ... 100 °C (Depending on the current carrying capacity/derating curve)

### Termination and connection method

Test for conductor damage and slackening	IEC 60999-1:1990-05
	Test passed

### Pull-out test

Pull-out test	IEC 60999-1:1990-05
	Test passed
Conductor cross section / conductor type / tensile force	0.14 mm <sup>2</sup> / solid / > 7 N
	0.14 mm <sup>2</sup> / flexible / > 7 N
	0.5 mm <sup>2</sup> / solid / > 30 N
	0.5 mm <sup>2</sup> / flexible / > 30 N

### Mechanical tests according to standard

Test specification	IEC 60999-1 (in parts)
--------------------	------------------------

### Electrical tests

Rated current	6 A
Conductor cross section	0.5 mm <sup>2</sup>
Rated voltage (III/2)	160 V
Rated surge voltage (III/2)	2.5 kV

### Air clearances and creepage distances

Clearances and creepage distances	IEC 60664-1:2007-04
Specification	IEC 60664-1:2007-04

# PCB terminal block - FFKDSA1/V-2,54- 6 - 1789579

## Technical data

### Air clearances and creepage distances

Minimum clearance - inhomogeneous field (III/3)	1.5 mm
Minimum clearance - inhomogeneous field (III/2)	1.5 mm
Minimum clearance - inhomogeneous field (II/2)	1.5 mm
Minimum creepage distance value (III/3)	1.6 mm
Minimum creepage distance value (III/2)	1.5 mm
Minimum creepage distance value (II/2)	1.6 mm

### Temperature-rise test

Specification	IEC 60998-1:1990-04
Result	Test passed
Requirement temperature-rise test	Increase in temperature $\leq 45$ K

### Current carrying capacity / derating curves

Caption	Type: FFKDS/V-2,54 Tested according to DIN EN 60512-5-2:2003-01 Reduction factor = 1 Number of positions: 5
Specification	Following IEC 60512-5-2:2002-02
Number of positions	5
Reduction factor	1

### Vibration test

Specification	IEC 60068-2-6:1982 + AMD 2:1985
Result	Test passed
Frequency	10 - 150 - 10 Hz
Sweep speed	1 octave/min
Amplitude	0.35 mm (10 - 60.1 Hz)
Acceleration	5 g (60.1 - 150 Hz)
Test duration per axis	2.5 h

### Insulation resistance

Specification	IEC 60512-2:1985-00
Result	Test passed
Insulation resistance, neighboring positions	$10^{12} \Omega$

### Standards and Regulations

Connection in acc. with standard	EN-VDE
	CSA
Flammability rating according to UL 94	V0

### Environmental Product Compliance

China RoHS	Environmentally friendly use period: unlimited = EFUP-e
	No hazardous substances above threshold values

## Drawings

# PCB terminal block - FFKDSA1/V-2,54- 6 - 1789579

Drilling diagram

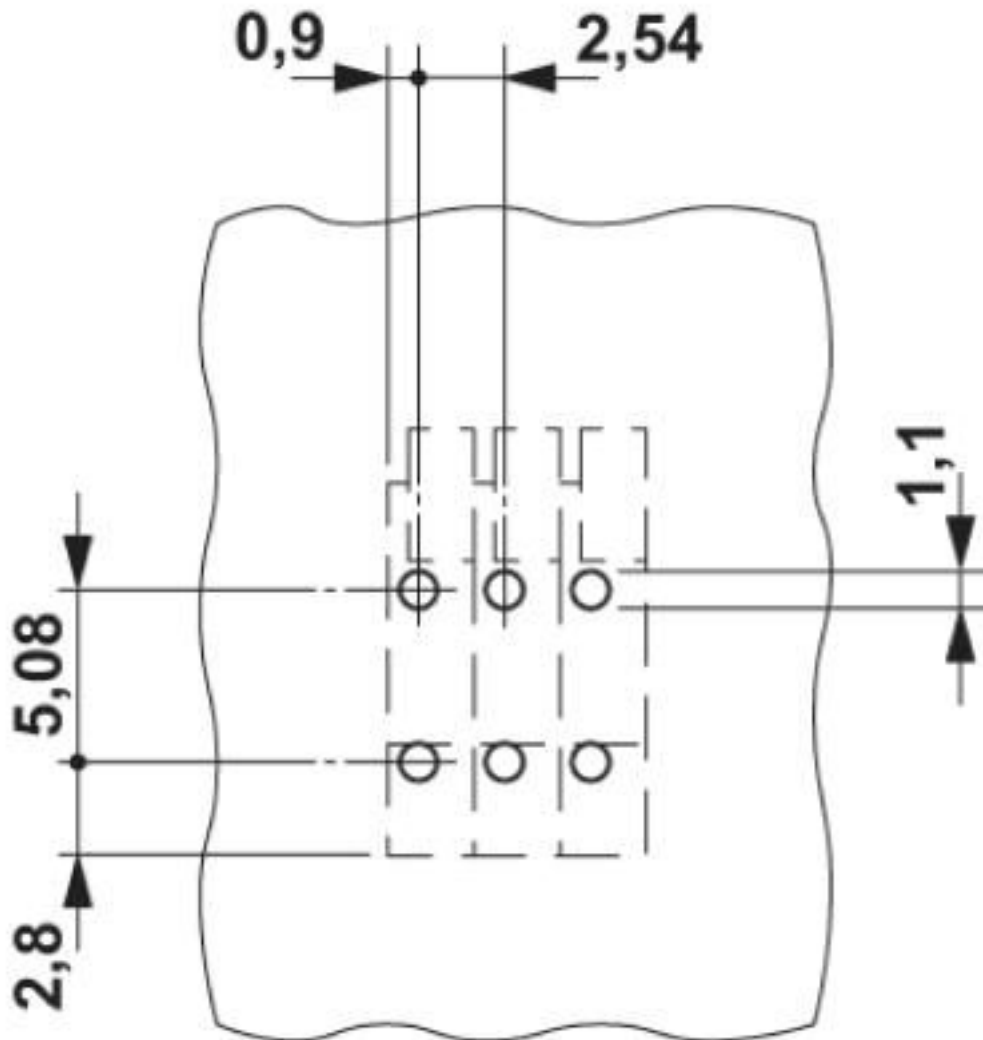

# PCB terminal block - FFKDSA1/V-2,54- 6 - 1789579

Diagram

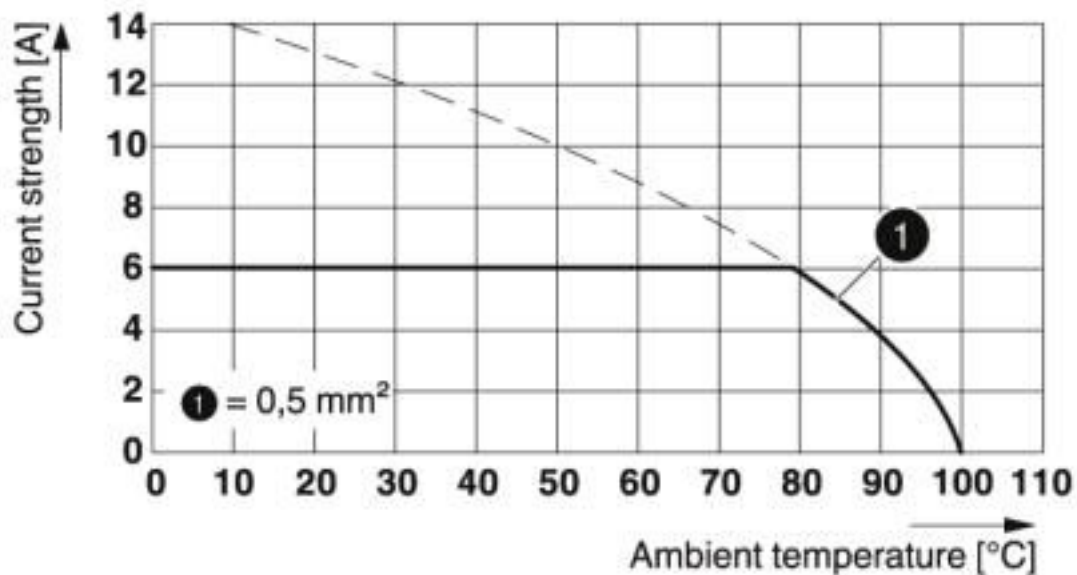

Type: FFKDS/V-2,54  
Tested according to DIN EN 60512-5-2:2003-01  
Reduction factor = 1  
Number of positions: 5

Dimensional drawing

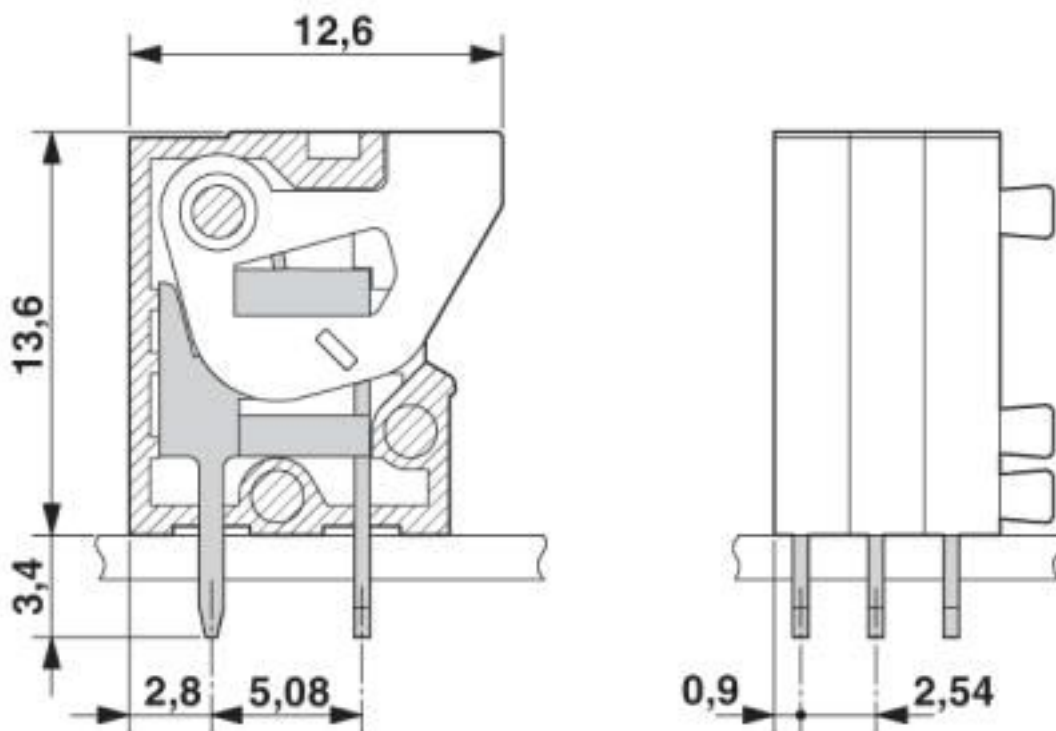

# PCB terminal block - FFKDSA1/V-2,54- 6 - 1789579

## Classifications

### eCl@ss

eCl@ss 10.0.1	27440401
eCl@ss 4.0	27141100
eCl@ss 4.1	27141100
eCl@ss 5.0	27141100
eCl@ss 5.1	27261100
eCl@ss 6.0	27261100
eCl@ss 7.0	27440401
eCl@ss 8.0	27440401
eCl@ss 9.0	27440401

### ETIM

ETIM 3.0	EC001121
ETIM 4.0	EC002643
ETIM 5.0	EC002643
ETIM 6.0	EC002643
ETIM 7.0	EC002643

### UNSPSC

UNSPSC 6.01	30211801
UNSPSC 7.0901	39121432
UNSPSC 11	39121432
UNSPSC 12.01	39121432
UNSPSC 13.2	39121432
UNSPSC 18.0	39121432
UNSPSC 19.0	39121432
UNSPSC 20.0	39121432
UNSPSC 21.0	39121432

## Approvals

### Approvals

---

Approvals

CSA / EAC / cULus Recognized

---

Ex Approvals

---

### Approval details

# PCB terminal block - FFKDSA1/V-2,54- 6 - 1789579

## Approvals

CSA		<a href="http://www.csagroup.org/services-industries/product-listing/">http://www.csagroup.org/services-industries/product-listing/</a>	13631
		B	
Nominal voltage UN	150 V		
Nominal current IN	6 A		
mm <sup>2</sup> /AWG/kcmil	20		

EAC			B.01687
-----	--	--	---------

cULus Recognized		<a href="http://database.ul.com/cgi-bin/XYV/template/LISEXT/1FRAME/index.htm">http://database.ul.com/cgi-bin/XYV/template/LISEXT/1FRAME/index.htm</a>	E60425-19870330
		B	
Nominal voltage UN	150 V		
Nominal current IN	6 A		
mm <sup>2</sup> /AWG/kcmil	26-20		

## Accessories

### Accessories

#### Cable end sleeve

Ferrule - AI 0,25-10 YE - 3241128



Ferrule, sleeve length: 10 mm, length: 14.5 mm, color: yellow

#### Labeled terminal marker

Marker card - SK 2,54/2,8:FORTL.ZAHLEN - 0804853



Marker card, Card, white, labeled, horizontal: consecutive numbers 1 ... 10, 11 ... 20, etc. up to 91 ... 99, mounting type: adhesive, for terminal block width: 2.54 mm, lettering field size: 2.54 x 2.8 mm

#### Marker pen



## PCB terminal block - FFKDSA1/V-2,54- 6 - 1789579

### Accessories

Marker pen - B-STIFT - 1051993



Marker pen, for manual labeling of unprinted Zack strips, smear-proof and waterproof, line thickness 0.5 mm

---

### Terminal marking

Marker strip - SK 2,8 WH:REEL - 0805205



Marker strip, Roll, white, unlabeled, can be labeled with: THERMOMARK ROLL 2.0, THERMOMARK ROLL, THERMOMARK ROLL X1, THERMOMARK ROLLMASTER 300/600, THERMOMARK X1.2, mounting type: adhesive, for terminal block width: 90000 mm, lettering field size: continuous x 2.8#mm, Number of individual labels: 480000

---

Marker card - SK U/2,8 WH:UNBEDRUCKT - 0803883



Marker card, Sheet, white, unlabeled, can be labeled with: PLOTMARK, CMS-P1-PLOTTER, Office printing systems, mounting type: adhesive, for terminal block width: 210 mm, lettering field size: 186 x 2.8 mm, Number of individual labels: 3600

---

Phoenix Contact 2020 © - all rights reserved  
<http://www.phoenixcontact.com>

PHOENIX CONTACT GmbH & Co. KG  
Flachsmarktstr. 8  
32825 Blomberg  
Germany  
Tel. +49 5235 300  
Fax +49 5235 3 41200  
<http://www.phoenixcontact.com>

## X-ON Electronics

Largest Supplier of Electrical and Electronic Components

*Click to view similar products for [Fixed Terminal Blocks](#) category:*

*Click to view products by [Phoenix Contact](#) manufacturer:*

Other Similar products are found below :

[MBE-1512](#) [MBE-154](#) [MBE-156](#) [MBES-153](#) [MBES-156](#) [MH-2512](#) [MHE-132](#) [MHE-163](#) [MI-254 \(35\)](#) [MI-272](#) [880507](#) [MPT-275](#)  
[15602-04-08-21](#) [BA311TU](#) [BA411SU](#) [MV-152](#) [MV-252-D](#) [MV-253/NCNOC](#) [MV-254-D](#) [MV-255](#) [MV-462](#) [MV-493](#) [MVE-252](#) [MVE-253](#)  
[MVE-273](#) [MVEB-153](#) [1700096](#) [1705142](#) [1712417](#) [1713020](#) [1713088](#) [1745195](#) [1760594](#) [1776118-2](#) [1790852](#) [1-796689-8](#) [1-796692-6](#)  
[1800001](#) [1800114](#) [1995279](#) [20020314-C121B01LF](#) [CB2-12](#) [KP03215000J0G](#) [KP04215000J0G](#) [S451](#) [282802-2](#) [29.007](#) [29.116](#) [30.103](#)  
[30.106](#)