

# Printed-circuit board connector - CC 2,5/ 4-GF-5,08-LR P26THR - 1792643

Please be informed that the data shown in this PDF Document is generated from our Online Catalog. Please find the complete data in the user's documentation. Our General Terms of Use for Downloads are valid (<http://phoenixcontact.com/download>)

PCB headers, nominal current: 12 A, rated voltage (III/2): 320 V, nominal cross section: 2.5 mm<sup>2</sup>, number of positions: 4, pitch: 5.08 mm, color: black, contact surface: Tin, mounting: THR soldering, pin layout: Linear pinning, solder pin [P]: 2.6 mm



The figure shows a 10-position version of the product

## Your advantages

- ✓ Designed for integration into the SMT soldering process
- ✓ Maximum flexibility when it comes to device design – one header for connectors with different connection technologies
- ✓ Screwable flange for superior mechanical stability
- ✓ Automatic locking and intuitive release through Lock and Release operating lever in contrasting color



## Key Commercial Data

Packing unit	50 pc
GTIN	
GTIN	4046356615655

## Technical data

### Dimensions

Length [ l ]	12 mm
Width	30.48 mm
Pitch	5.08 mm
Dimension a	15.24 mm
Width [ w ]	30.48 mm
Height [ h ]	11.2 mm
Installed height	8.6 mm
Length of the solder pin	2.6 mm
Pin dimensions	1 x 1 mm
Length	12 mm

# Printed-circuit board connector - CC 2,5/ 4-GF-5,08-LR P26THR - 1792643

## Technical data

### General

Range of articles	CC 2,5/...GF-LR
Insulating material group	IIIa
Rated surge voltage (III/3)	4 kV
Rated surge voltage (III/2)	4 kV
Rated surge voltage (II/2)	4 kV
Rated voltage (III/3)	250 V
Rated voltage (III/2)	320 V
Rated voltage (II/2)	400 V
Connection in acc. with standard	EN-VDE
Nominal current I <sub>N</sub>	12 A
Insulating material	LCP
Flammability rating according to UL 94	V0
Color	black
Number of positions	4

### Standards and Regulations

Connection in acc. with standard	EN-VDE
	CUL
Flammability rating according to UL 94	V0

### Environmental Product Compliance

REACH SVHC	Lead 7439-92-1
China RoHS	Environmentally Friendly Use Period = 50 years
	For details about hazardous substances go to tab "Downloads", Category "Manufacturer's declaration"

## Drawings

# Printed-circuit board connector - CC 2,5/ 4-GF-5,08-LR P26THR - 1792643

Drilling diagram

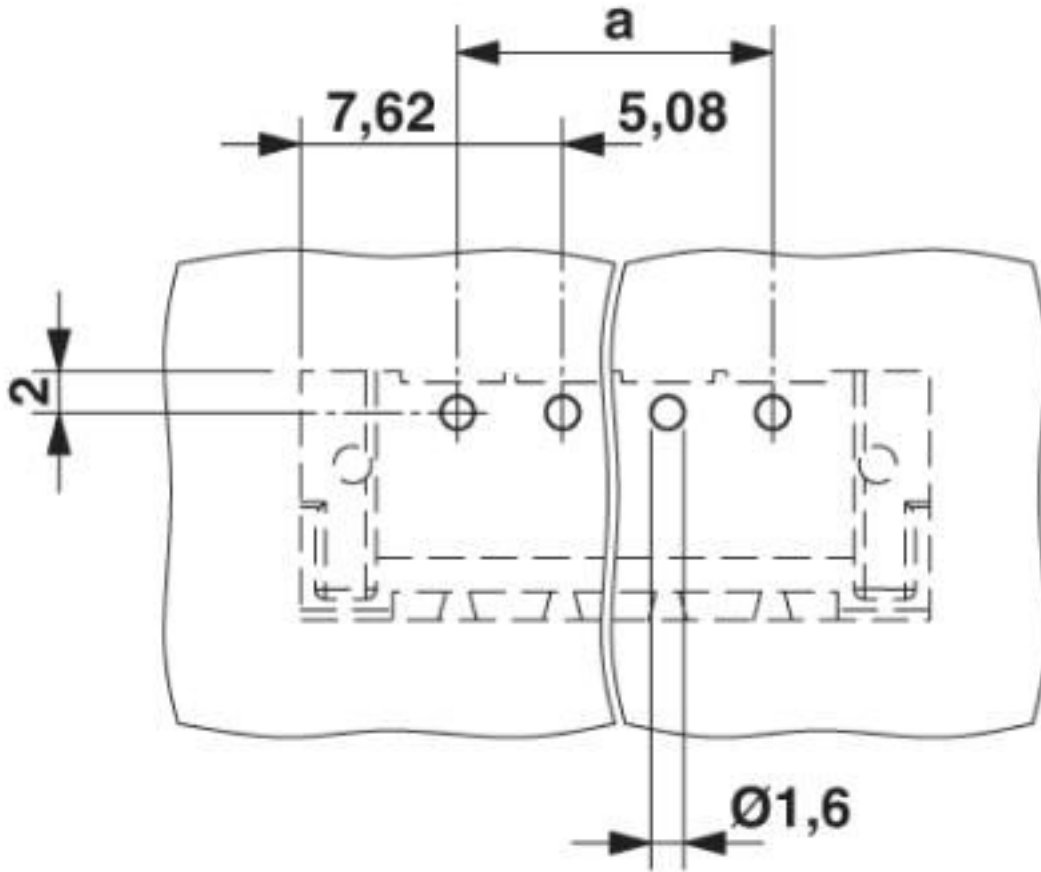

# Printed-circuit board connector - CC 2,5/ 4-GF-5,08-LR P26THR - 1792643

Diagram

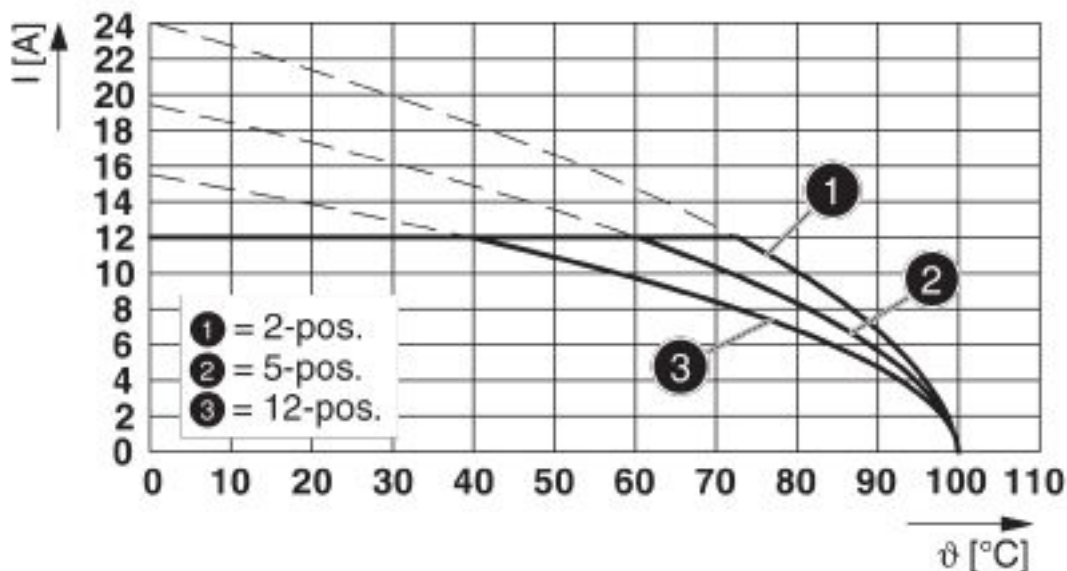

Type: MVSTB(R/W) 2,5/...-STF-5,08 with CC 2,5/...-GF-5,08-LR P...THR

Diagram

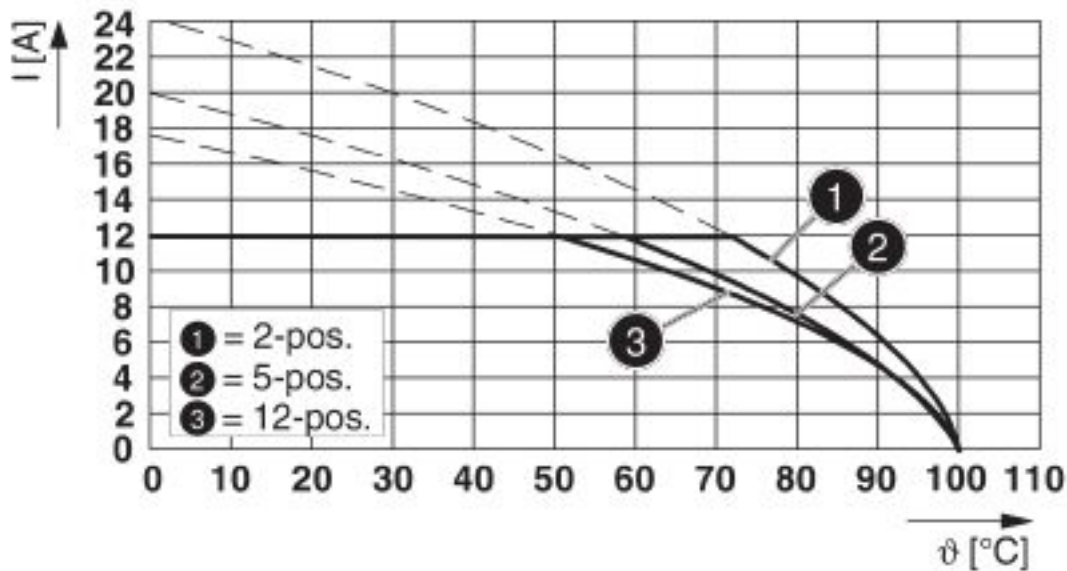

Type: SMSTB 2,5/...-STF-5,08 with CC 2,5/...-GF-5,08-LR P...THR

# Printed-circuit board connector - CC 2,5/ 4-GF-5,08-LR P26THR - 1792643

Diagram

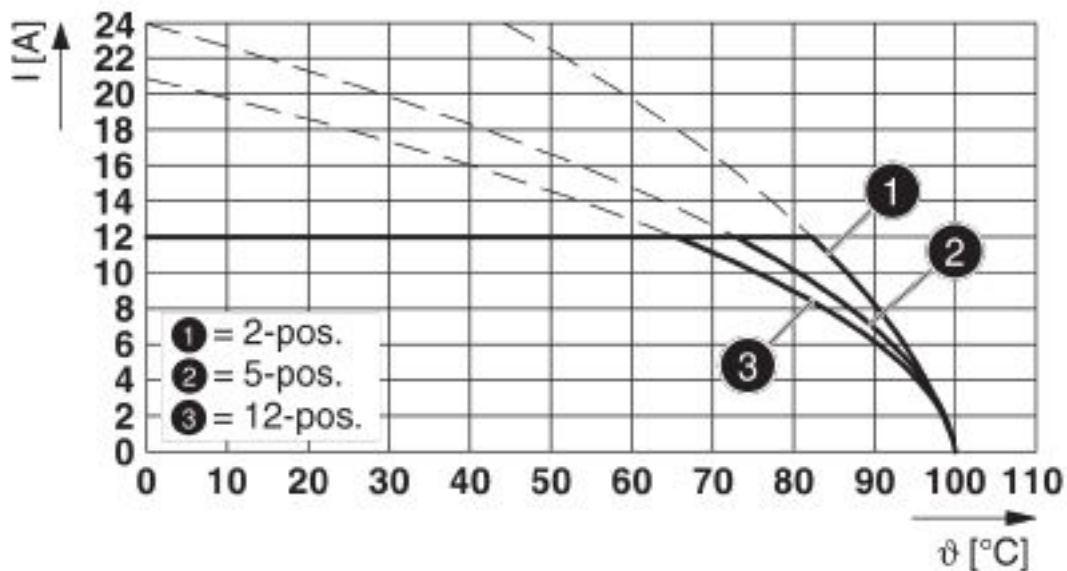

Type: MSTBT 2,5/...-STF-5,08 with CC 2,5/...-GF-5,08-LR P...THR

Diagram

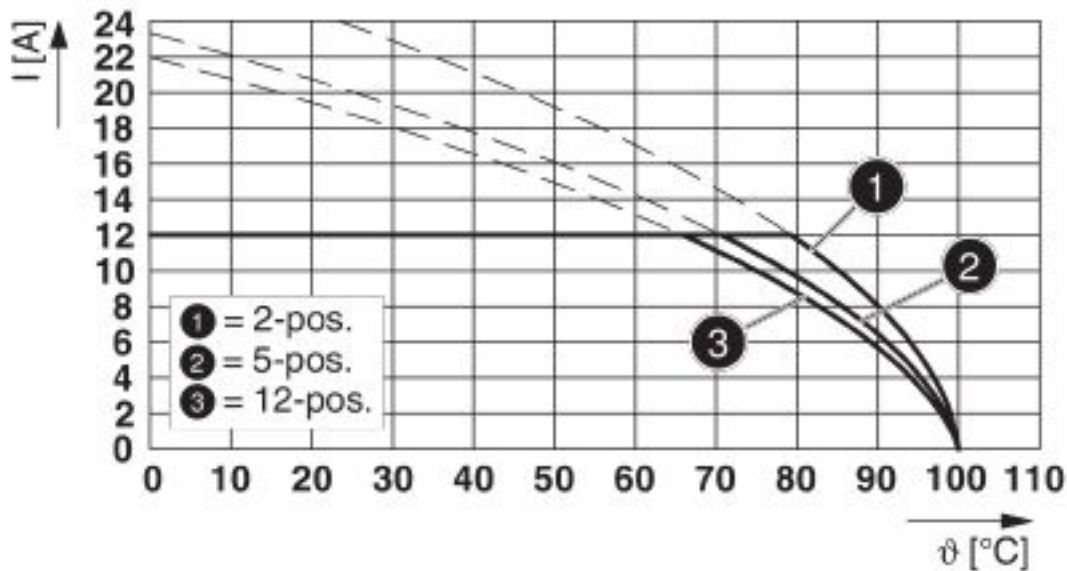

Type: FRONT-MSTB 2,5/...-STF-5,08 with CC 2,5/...-GF-5,08-LR P...THR

# Printed-circuit board connector - CC 2,5/ 4-GF-5,08-LR P26THR - 1792643

Diagram

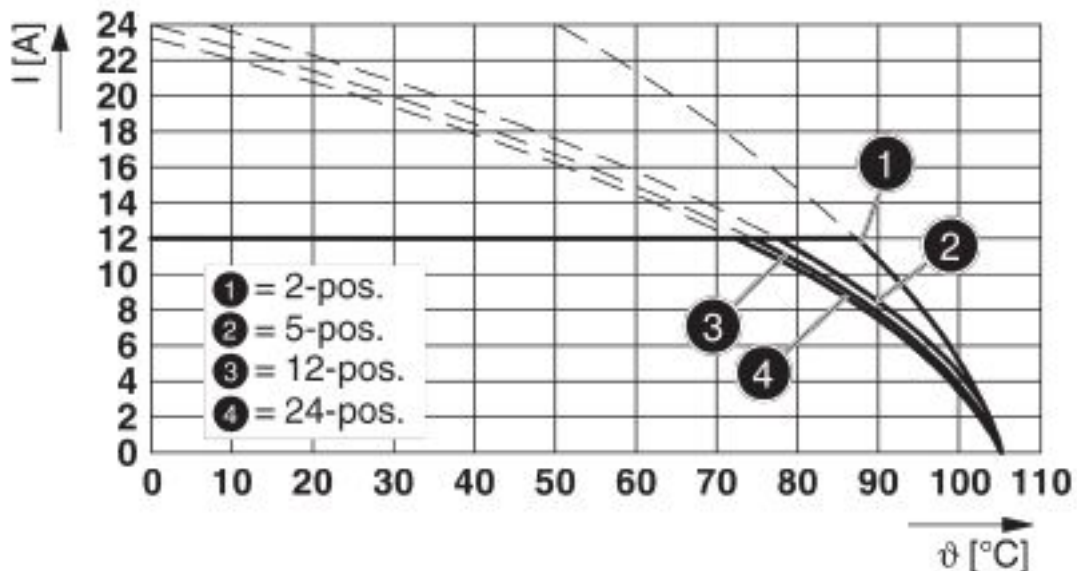

Type: MSTB 2,5/...-STF-5,08 with CC 2,5/...-GF-5,08-LR P...THR

Diagram

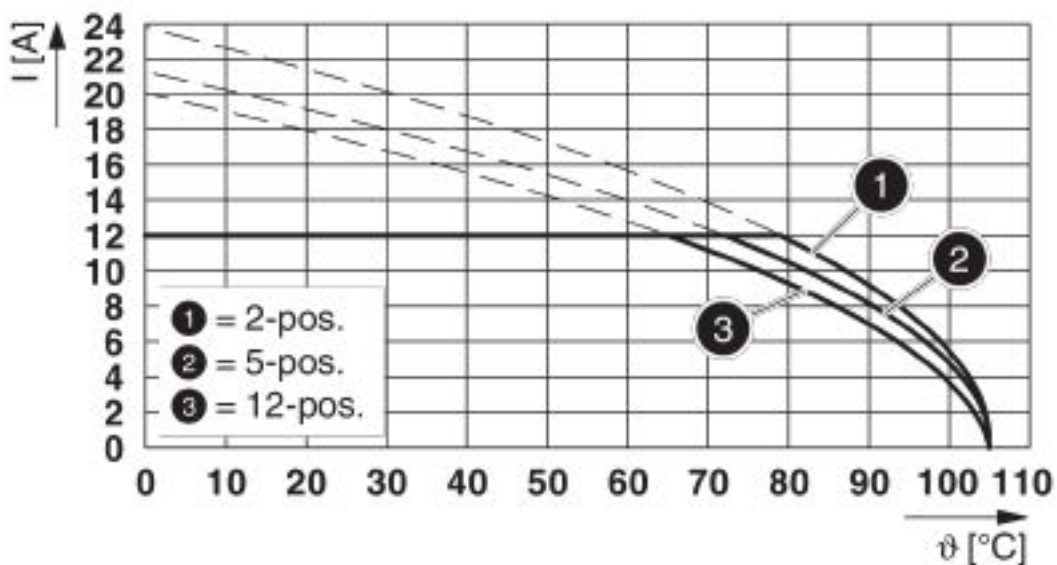

Type: FKCS 2,5/...-STF-5,08 with CC 2,5/...-GF-5,08-LR P...THR

# Printed-circuit board connector - CC 2,5/ 4-GF-5,08-LR P26THR - 1792643

Diagram

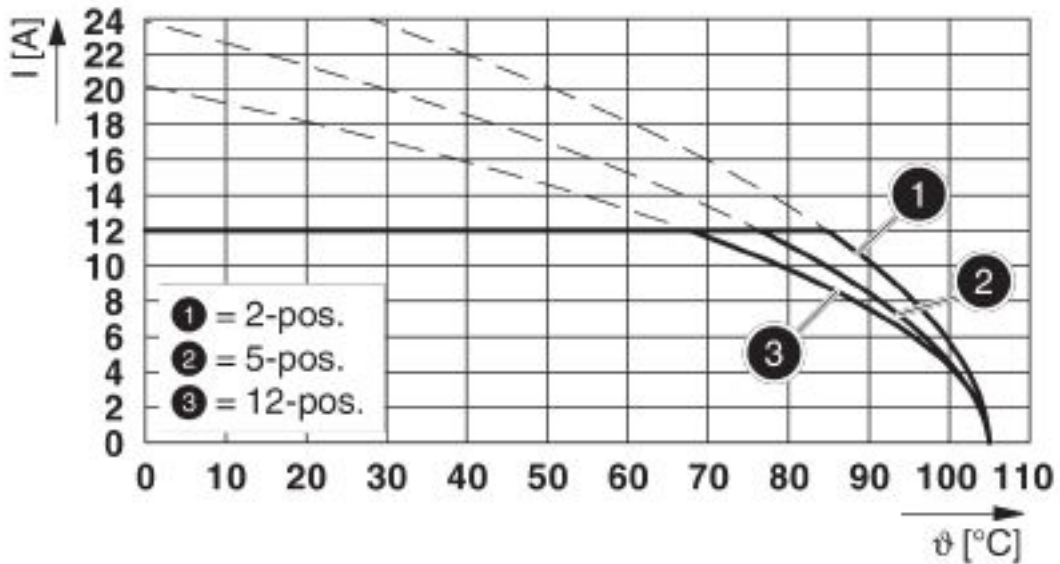

Type: FKCN 2,5/...-STF-5,08 with CC 2,5/...-GF-5,08-LR P...THR

Diagram

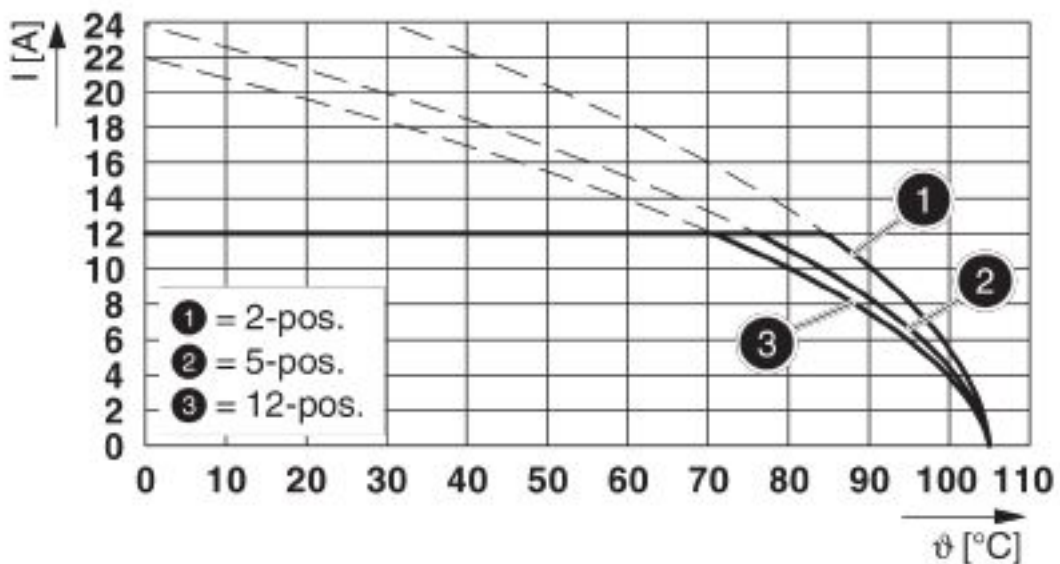

Type: FKCT 2,5/...-STF-5,08 with CC 2,5/...-GF-5,08-LR P...THR

# Printed-circuit board connector - CC 2,5/ 4-GF-5,08-LR P26THR - 1792643

Diagram

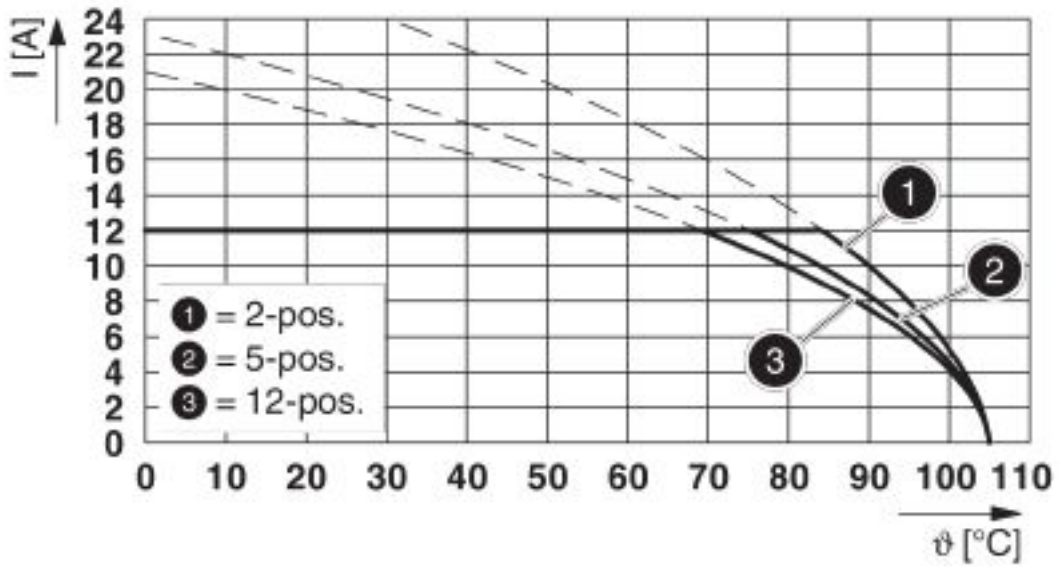

Type: FKCVR 2,5/...-STF-5,08 with CC 2,5/...-GF-5,08-LR P...THR

Diagram

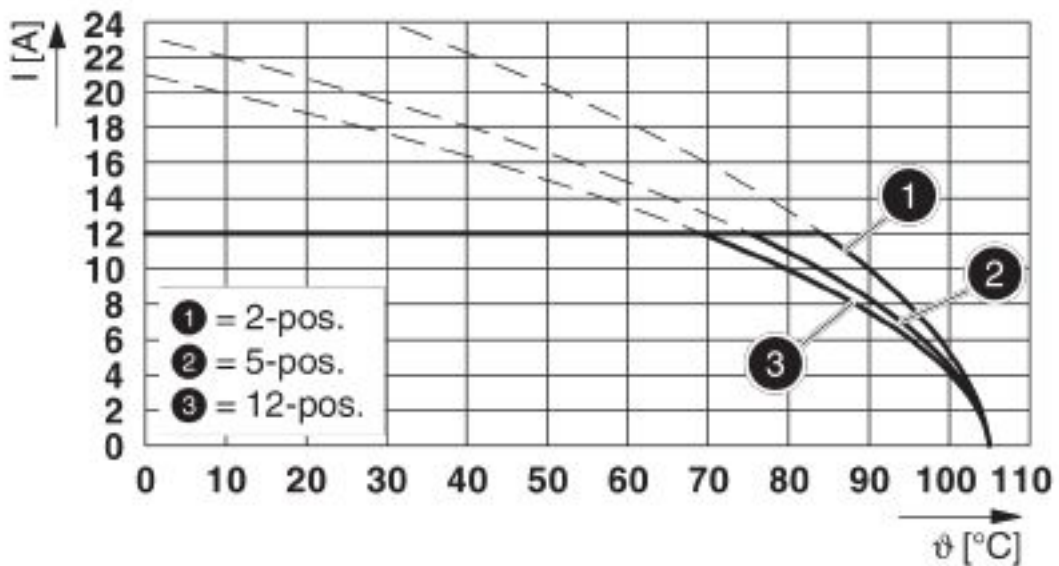

Type: FKCVW 2,5/...-STF-5,08 with CC 2,5/...-GF-5,08-LR P...THR



# Printed-circuit board connector - CC 2,5/ 4-GF-5,08-LR P26THR - 1792643

Schematic diagram

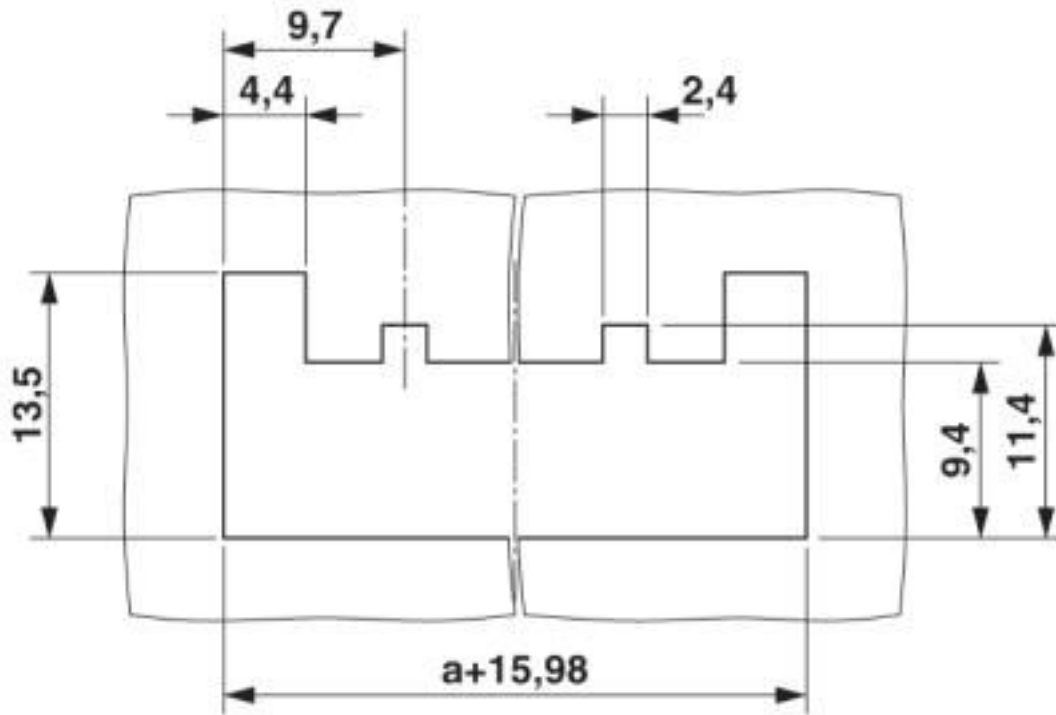

Panel cutout

## Classifications

eCl@ss

eCl@ss 10.0.1	27440402
eCl@ss 4.0	27260700
eCl@ss 4.1	27260700
eCl@ss 5.0	27260700
eCl@ss 5.1	27260700
eCl@ss 6.0	27260700
eCl@ss 7.0	27440402
eCl@ss 8.0	27440402
eCl@ss 9.0	27440402

ETIM

ETIM 4.0	EC002637
ETIM 5.0	EC002637
ETIM 6.0	EC002637
ETIM 7.0	EC002637

# Printed-circuit board connector - CC 2,5/ 4-GF-5,08-LR P26THR - 1792643

## Classifications

### UNSPSC

UNSPSC 6.01	30211810
UNSPSC 7.0901	39121409
UNSPSC 11	39121409
UNSPSC 12.01	39121409
UNSPSC 13.2	39121409
UNSPSC 18.0	39121409
UNSPSC 19.0	39121409
UNSPSC 20.0	39121409
UNSPSC 21.0	39121409

## Approvals

### Approvals

#### Approvals

IECEE CB Scheme / VDE Gutachten mit Fertigungsüberwachung / EAC / cULus Recognized

#### Ex Approvals

### Approval details

IECEE CB Scheme		<a href="http://www.iecee.org/">http://www.iecee.org/</a>	DE1-58421-B1B2
Nominal voltage UN	400 V		
Nominal current IN	12 A		

VDE Gutachten mit Fertigungsüberwachung		<a href="http://www2.vde.com/de/Institut/Online-Service/VDE-gepruefteProdukte/Seiten/Online-Suche.aspx">http://www2.vde.com/de/Institut/Online-Service/VDE-gepruefteProdukte/Seiten/Online-Suche.aspx</a>	40041286
Nominal voltage UN	400 V		
Nominal current IN	12 A		

EAC		B.01687
-----	--	---------

# Printed-circuit board connector - CC 2,5/ 4-GF-5,08-LR P26THR - 1792643

## Approvals

cULus Recognized		<a href="http://database.ul.com/cgi-bin/XYV/template/LISEXT/1FRAME/index.htm">http://database.ul.com/cgi-bin/XYV/template/LISEXT/1FRAME/index.htm</a>	E60425-19931011
	B	D	
Nominal voltage UN	300 V	300 V	
Nominal current IN	16 A	10 A	

## Accessories

### Accessories

#### Coding element

Coding section - CR-MSTB - 1734401

Coding section, inserted into the recess in the header or the inverted plug, red insulating material



Coding section - CR-MSTB NAT HT - 1954362

HT coding section, prior to the reflow soldering process it is inserted into the recess on the header, made from high-temperature-resistant beige insulation material



Phoenix Contact 2020 © - all rights reserved  
<http://www.phoenixcontact.com>

PHOENIX CONTACT GmbH & Co. KG  
Flachsmarktstr. 8  
32825 Blomberg  
Germany  
Tel. +49 5235 300  
Fax +49 5235 3 41200  
<http://www.phoenixcontact.com>

## X-ON Electronics

Largest Supplier of Electrical and Electronic Components

*Click to view similar products for [Pluggable Terminal Blocks](#) category:*

*Click to view products by [Phoenix Contact](#) manufacturer:*

Other Similar products are found below :

[57.510.0053](#) [MC 1.5/ 6-ST-3.5 GY AU](#) [ET02015000J0G](#) [734-104](#) [734-302](#) [8-141-P](#) [8426620000](#) [860505](#) [860516](#) [860810](#) [GBPACX-12](#)  
[93.731.4953.0](#) [PV05-5,08-K](#) [PVP02-5,00](#) [PVP03-3,50](#) [PVP04-3,50](#) [PVS02-5,00](#) [1-1986160-3](#) [1377680000](#) [1531000000](#) [1546228-5](#)  
[ELFH16150](#) [ELFP03110](#) [ELFP10210](#) [ELFT06250](#) [ELVP03100](#) [1700101](#) [1700410](#) [1700425](#) [1702246](#) [1705229](#) [1710175](#) [1714537](#) [1717806](#)  
[1719600](#) [1728941](#) [1734692](#) [1734795](#) [1736036](#) [1740194](#) [1740291](#) [1740628](#) [1740990](#) [1746952](#) [1750207](#) [1752441](#) [1752865](#) [1754115](#)  
[1754144](#) [1756913](#)