

Printed-circuit board connector - CC 2,5/12-GF-5,08-LR P26THR - 1792724

Please be informed that the data shown in this PDF Document is generated from our Online Catalog. Please find the complete data in the user's documentation. Our General Terms of Use for Downloads are valid (<http://phoenixcontact.com/download>)

PCB headers, nominal current: 12 A, rated voltage (III/2): 320 V, nominal cross section: 2.5 mm², number of positions: 12, pitch: 5.08 mm, color: black, contact surface: Tin, mounting: THR soldering, pin layout: Linear pinning, solder pin [P]: 2.6 mm



The figure shows a 10-position version of the product

Your advantages

- Designed for integration into the SMT soldering process
- Maximum flexibility when it comes to device design – one header for connectors with different connection technologies
- Screwable flange for superior mechanical stability
- Automatic locking and intuitive release through Lock and Release operating lever in contrasting color



Key Commercial Data

Packing unit	50 pc
GTIN	
GTIN	4046356615730

Technical data

Dimensions

Length [l]	12 mm
Width	71.12 mm
Pitch	5.08 mm
Dimension a	55.88 mm
Width [w]	71.12 mm
Height [h]	11.17 mm
Installed height	8.57 mm
Length of the solder pin	2.6 mm
Pin dimensions	1 x 1 mm
Length	12 mm

Printed-circuit board connector - CC 2,5/12-GF-5,08-LR P26THR - 1792724

Technical data

General

Range of articles	CC 2,5/...GF-LR
Insulating material group	IIIa
Rated surge voltage (III/3)	4 kV
Rated surge voltage (III/2)	4 kV
Rated surge voltage (II/2)	4 kV
Rated voltage (III/3)	250 V
Rated voltage (III/2)	320 V
Rated voltage (II/2)	400 V
Connection in acc. with standard	EN-VDE
Nominal current I _N	12 A
Insulating material	LCP
Flammability rating according to UL 94	V0
Color	black
Number of positions	12

Standards and Regulations

Connection in acc. with standard	EN-VDE
	CUL
Flammability rating according to UL 94	V0

Environmental Product Compliance

REACH SVHC	Lead 7439-92-1
China RoHS	Environmentally Friendly Use Period = 50 years
	For details about hazardous substances go to tab "Downloads", Category "Manufacturer's declaration"

Drawings

Printed-circuit board connector - CC 2,5/12-GF-5,08-LR P26THR - 1792724

Drilling diagram

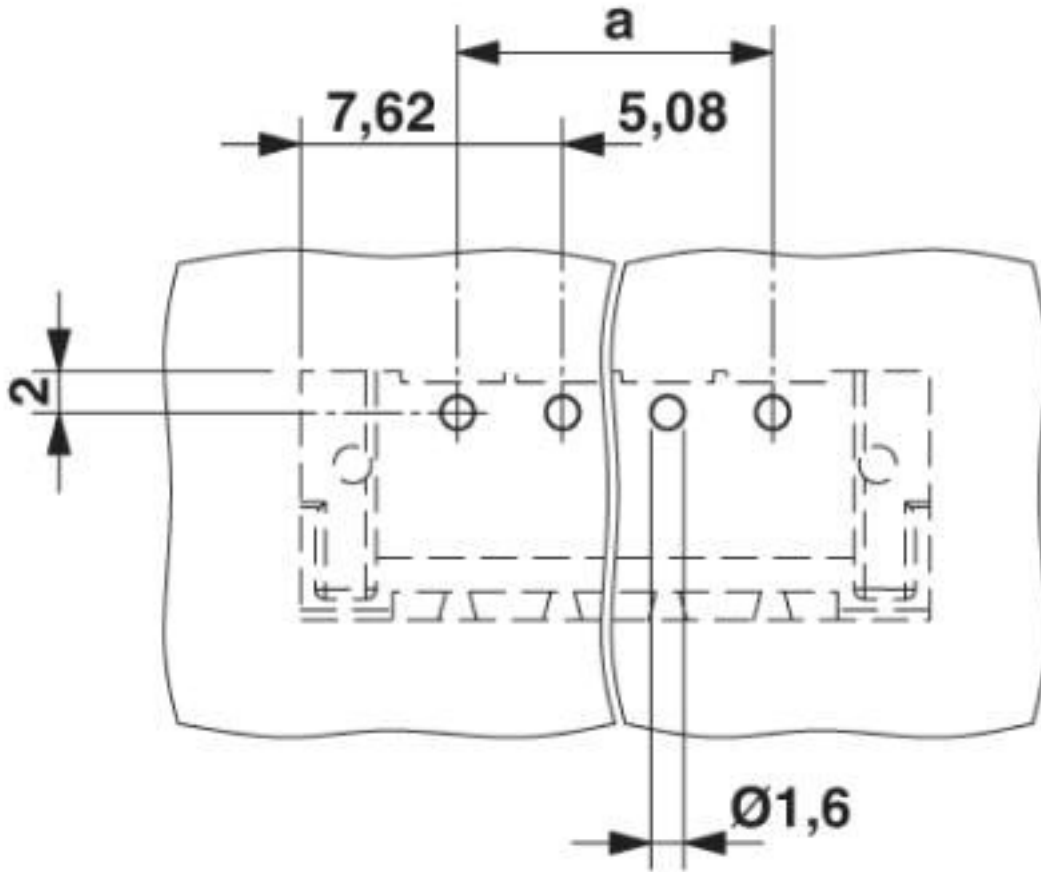

Printed-circuit board connector - CC 2,5/12-GF-5,08-LR P26THR - 1792724

Diagram

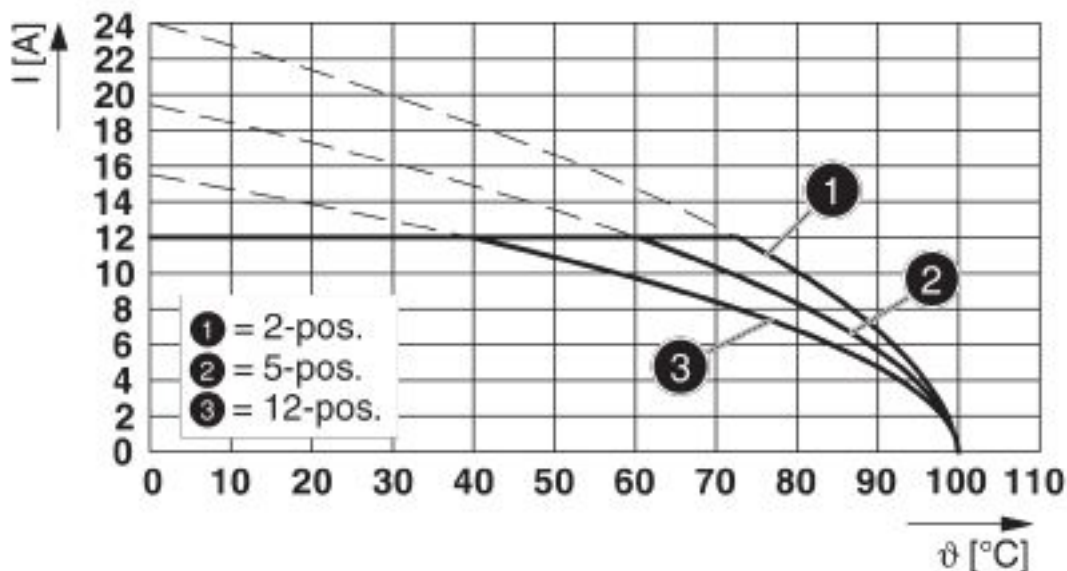

Type: MVSTB(R/W) 2,5/...-STF-5,08 with CC 2,5/...-GF-5,08-LR P...THR

Diagram

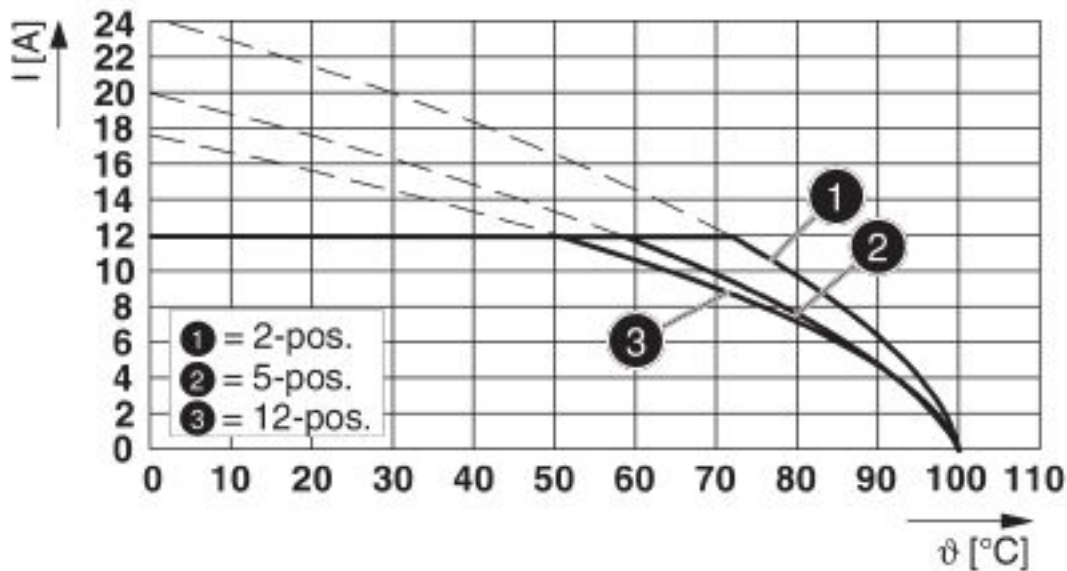

Type: SMSTB 2,5/...-STF-5,08 with CC 2,5/...-GF-5,08-LR P...THR

Printed-circuit board connector - CC 2,5/12-GF-5,08-LR P26THR - 1792724

Diagram

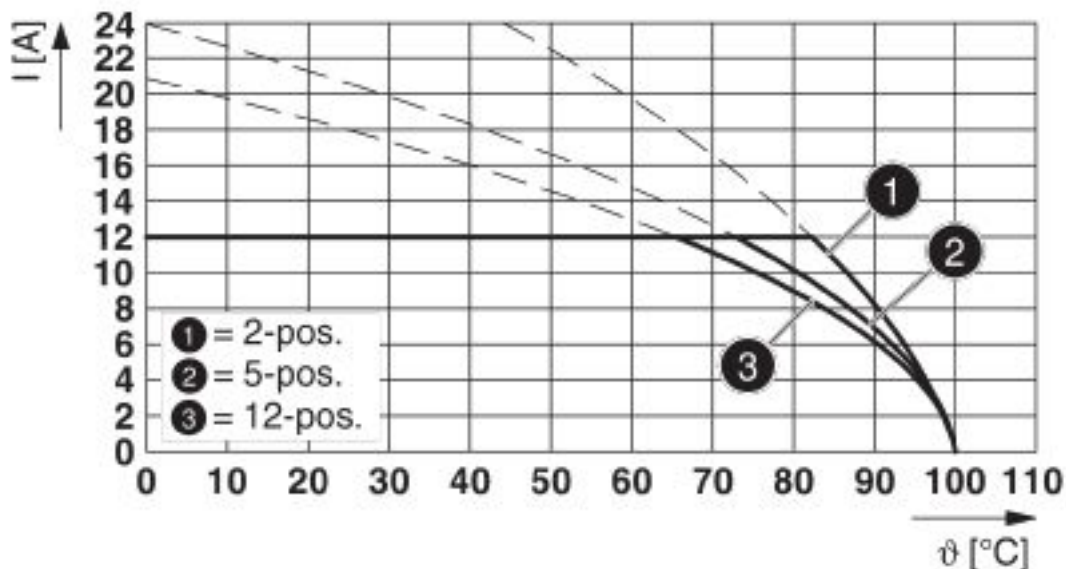

Type: MSTBT 2,5/...-STF-5,08 with CC 2,5/...-GF-5,08-LR P...THR

Diagram

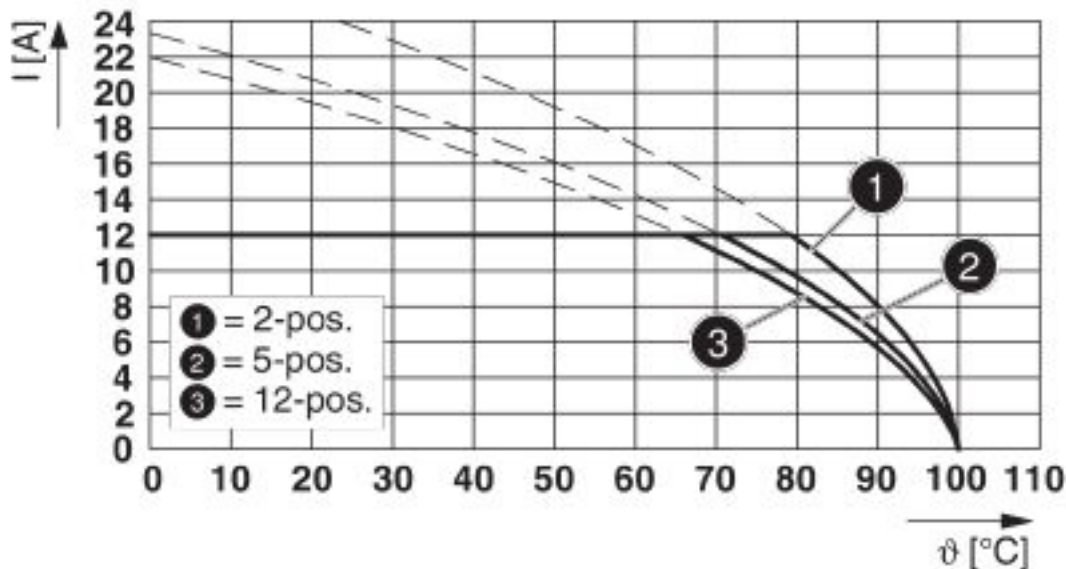

Type: FRONT-MSTB 2,5/...-STF-5,08 with CC 2,5/...-GF-5,08-LR P...THR

Printed-circuit board connector - CC 2,5/12-GF-5,08-LR P26THR - 1792724

Diagram

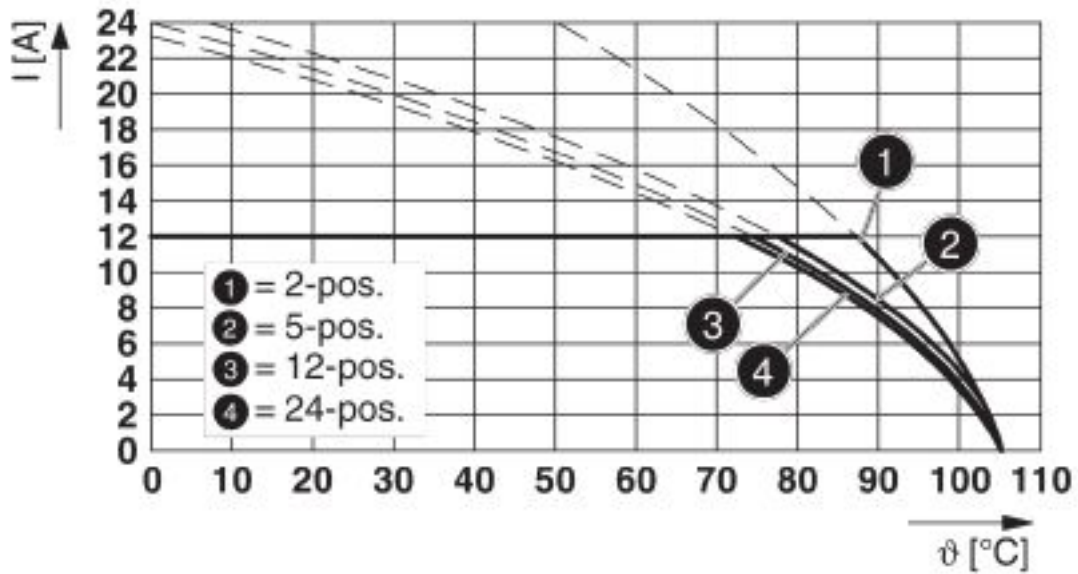

Type: MSTB 2,5/...-STF-5,08 with CC 2,5/...-GF-5,08-LR P...THR

Diagram

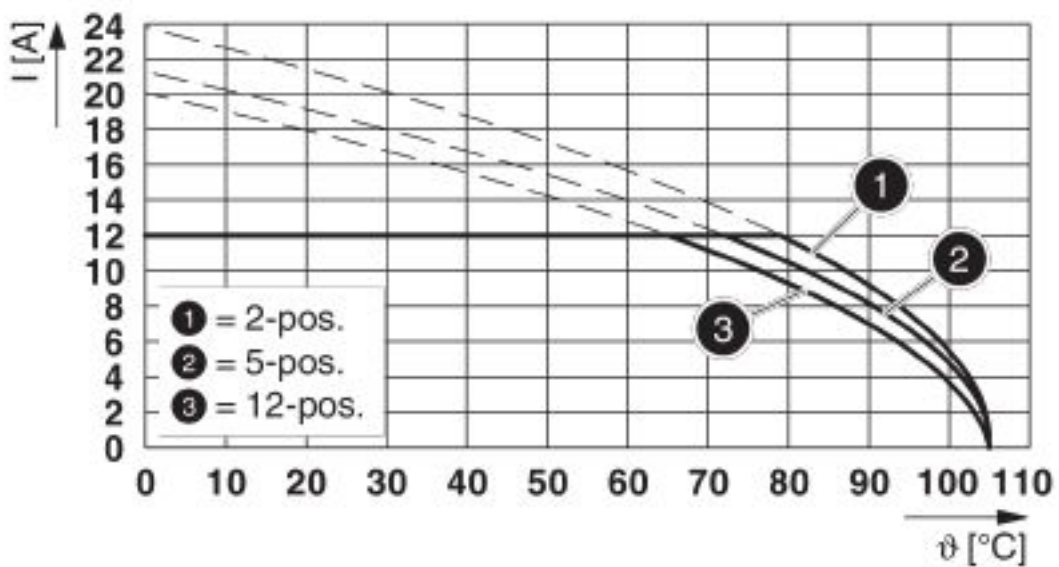

Type: FKCS 2,5/...-STF-5,08 with CC 2,5/...-GF-5,08-LR P...THR

Printed-circuit board connector - CC 2,5/12-GF-5,08-LR P26THR - 1792724

Diagram

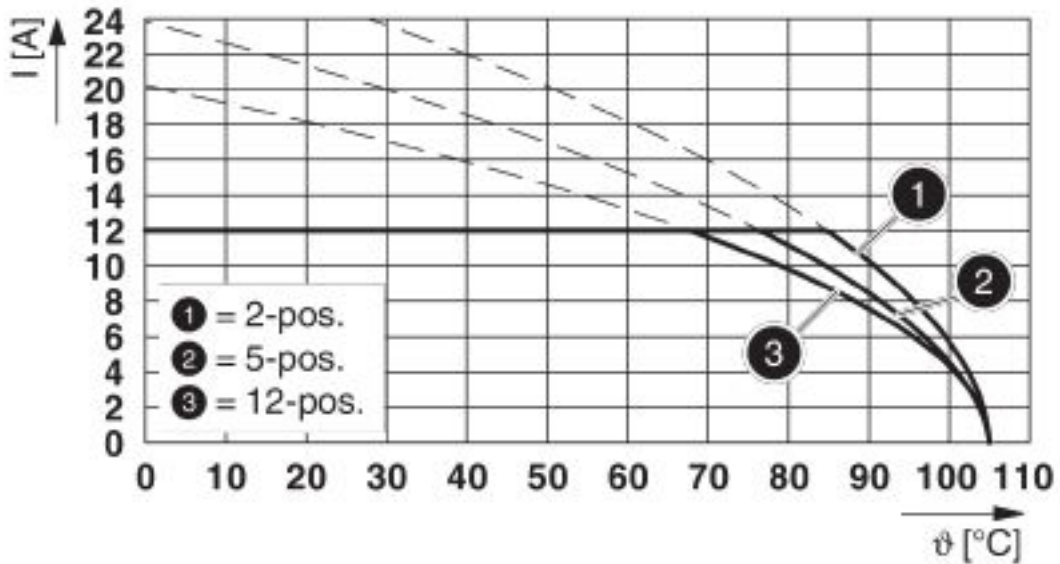

Type: FKCN 2,5/...-STF-5,08 with CC 2,5/...-GF-5,08-LR P...THR

Diagram

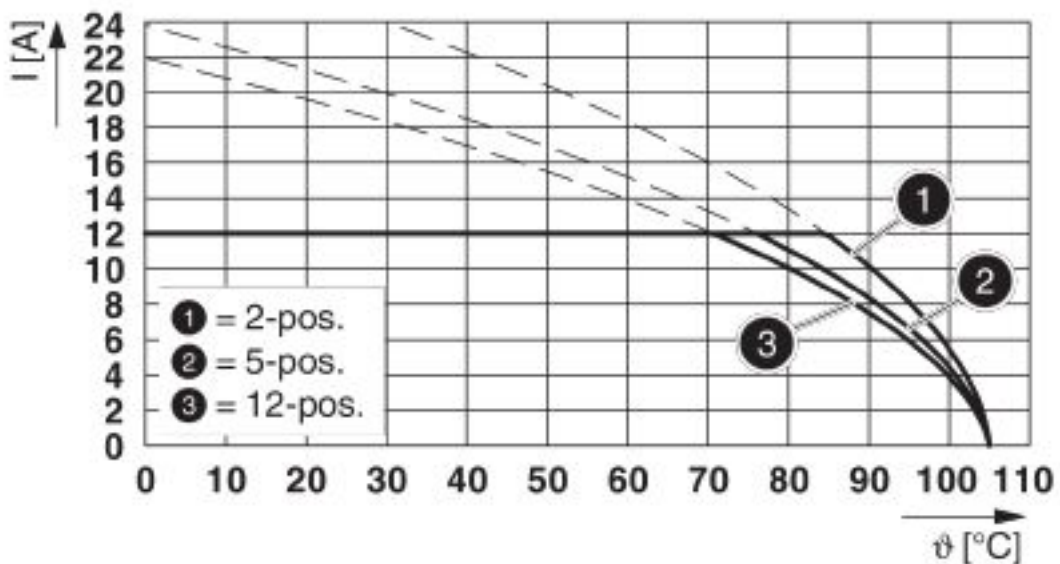

Type: FKCT 2,5/...-STF-5,08 with CC 2,5/...-GF-5,08-LR P...THR

Printed-circuit board connector - CC 2,5/12-GF-5,08-LR P26THR - 1792724

Diagram

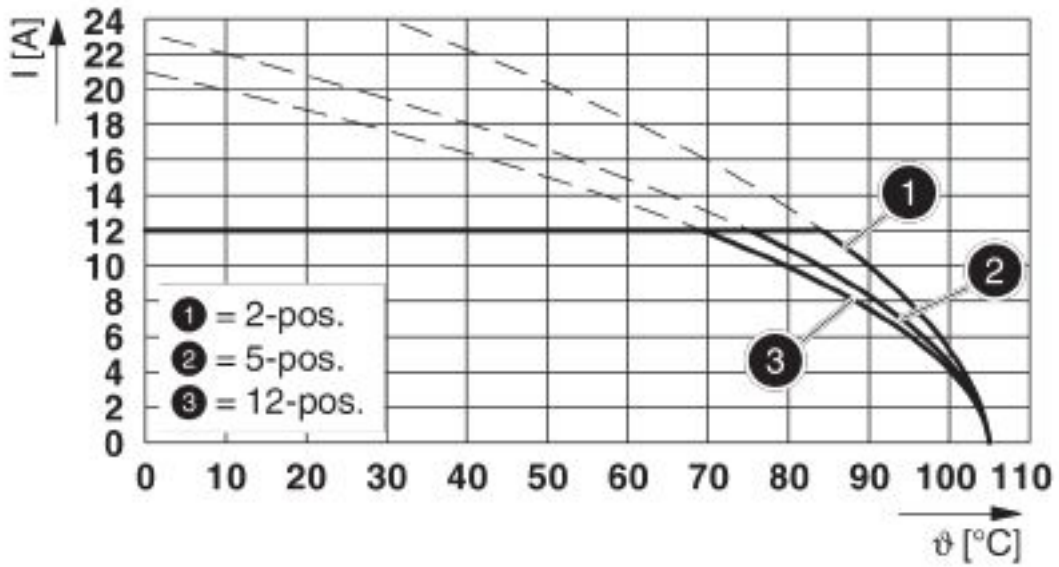

Type: FKCVR 2,5/...-STF-5,08 with CC 2,5/...-GF-5,08-LR P...THR

Diagram

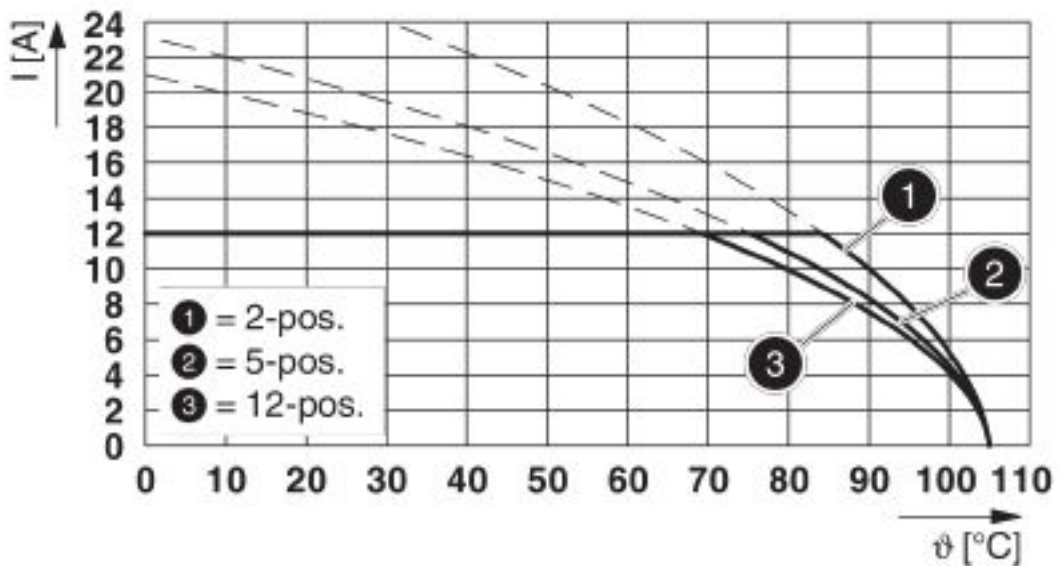

Type: FKCVW 2,5/...-STF-5,08 with CC 2,5/...-GF-5,08-LR P...THR

Printed-circuit board connector - CC 2,5/12-GF-5,08-LR P26THR - 1792724

Schematic diagram

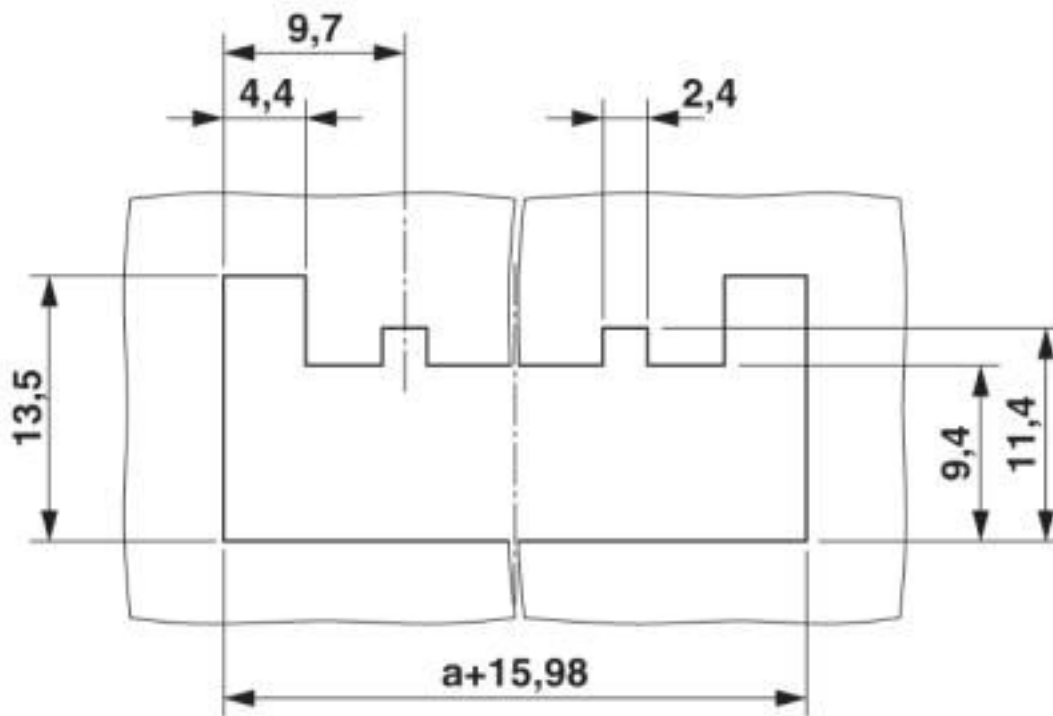

Panel cutout

Classifications

eCl@ss

eCl@ss 10.0.1	27440402
eCl@ss 4.0	27260700
eCl@ss 4.1	27260700
eCl@ss 5.0	27260700
eCl@ss 5.1	27260700
eCl@ss 6.0	27260700
eCl@ss 7.0	27440402
eCl@ss 8.0	27440402
eCl@ss 9.0	27440402

ETIM

ETIM 4.0	EC002637
ETIM 5.0	EC002637
ETIM 6.0	EC002637
ETIM 7.0	EC002637

Printed-circuit board connector - CC 2,5/12-GF-5,08-LR P26THR - 1792724

Classifications

UNSPSC

UNSPSC 6.01	30211810
UNSPSC 7.0901	39121409
UNSPSC 11	39121409
UNSPSC 12.01	39121409
UNSPSC 13.2	39121409
UNSPSC 18.0	39121409
UNSPSC 19.0	39121409
UNSPSC 20.0	39121409
UNSPSC 21.0	39121409

Approvals

Approvals

Approvals

IECEE CB Scheme / VDE Gutachten mit Fertigungsüberwachung / EAC / cULus Recognized

Ex Approvals

Approval details

IECEE CB Scheme		http://www.iecee.org/	DE1-58421-B1B2
Nominal voltage UN	400 V		
Nominal current IN	12 A		

VDE Gutachten mit Fertigungsüberwachung		http://www2.vde.com/de/Institut/Online-Service/VDE-gepruefteProdukte/Seiten/Online-Suche.aspx	40041286
Nominal voltage UN	400 V		
Nominal current IN	12 A		

EAC		B.01687
-----	---	---------

Printed-circuit board connector - CC 2,5/12-GF-5,08-LR P26THR - 1792724

Approvals

cULus Recognized		http://database.ul.com/cgi-bin/XYV/template/LISEXT/1FRAME/index.htm	E60425-19931011
	B	D	
Nominal voltage UN	300 V	300 V	
Nominal current IN	16 A	10 A	

Accessories

Accessories

Coding element

Coding section - CR-MSTB - 1734401

Coding section, inserted into the recess in the header or the inverted plug, red insulating material



Coding section - CR-MSTB NAT HT - 1954362

HT coding section, prior to the reflow soldering process it is inserted into the recess on the header, made from high-temperature-resistant beige insulation material



Phoenix Contact 2020 © - all rights reserved
<http://www.phoenixcontact.com>

PHOENIX CONTACT GmbH & Co. KG
Flachsmarktstr. 8
32825 Blomberg
Germany
Tel. +49 5235 300
Fax +49 5235 3 41200
<http://www.phoenixcontact.com>

X-ON Electronics

Largest Supplier of Electrical and Electronic Components

Click to view similar products for [Pluggable Terminal Blocks](#) category:

Click to view products by [Phoenix Contact](#) manufacturer:

Other Similar products are found below :

[57.510.0053](#) [MC 1.5/ 6-ST-3.5 GY AU](#) [734-104](#) [734-302](#) [8-141-P](#) [8426620000](#) [860505](#) [860810](#) [GBPACX-12](#) [93.731.4953.0](#) [PV05-5,08-K](#)
[PVP02-5,00](#) [PVP03-3,50](#) [PVP04-3,50](#) [PVS02-5,00](#) [1-1986160-3](#) [1377680000](#) [1531000000](#) [1546228-5](#) [ELFH16150](#) [ELFP03110](#)
[ELFP10210](#) [ELFT06250](#) [ELVP03100](#) [1700101](#) [1700410](#) [1700425](#) [1702246](#) [1705229](#) [1710175](#) [1714537](#) [1717806](#) [1719600](#) [1728941](#)
[1734692](#) [1734795](#) [1736036](#) [1740194](#) [1740291](#) [1740628](#) [1740990](#) [1746952](#) [1750207](#) [1752441](#) [1752865](#) [1754115](#) [1754144](#) [1756913](#)
[1760051](#) [1760336](#)