

Printed-circuit board connector - MVSTBR 2,5/11-STF-5,08 EX - 1809762

Please be informed that the data shown in this PDF Document is generated from our Online Catalog. Please find the complete data in the user's documentation. Our General Terms of Use for Downloads are valid (<http://phoenixcontact.com/download>)

PCB connector, nominal current: 12 A, nominal cross section: 2.5 mm², number of positions: 11, pitch: 5.08 mm, connection method: Screw connection with tension sleeve, color: green, contact surface: Tin



The figure shows a 10-position version of the product

Your advantages

- Well-known connection principle allows worldwide use
- Low temperature rise, thanks to maximum contact force
- Screwable flange for superior mechanical stability
- Satisfies the more stringent safety requirements of "Ex eb" protection according to IEC 60079-7 for potentially explosive areas



Key Commercial Data

Packing unit	50 pc
GTIN	
GTIN	4046356705165

Technical data

Item properties

Brief article description	Printed-circuit board connector
Plug-in system	CLASSIC COMBICON (EX)
Type of contact	Female connector
Range of articles	MVSTBR 2,5/...-STF-EX
Pitch	5.08 mm
Number of positions	11
Connection method	Screw connection with tension sleeve
Drive form screw head	Slotted (L)
Screw thread	M3
Locking	Screw flange
Number of levels	1

Printed-circuit board connector - MVSTBR 2,5/11-STF-5,08 EX - 1809762

Technical data

Item properties

Number of connections	11
Number of potentials	11

Electrical parameters

Nominal current	12 A
Nom. voltage	176 V
Rated current	12 A

Connection capacity

Connection method	Screw connection with tension sleeve
pluggable	Yes
Conductor cross section solid	0.2 mm ² ... 2.5 mm ²
Conductor cross section flexible	0.2 mm ² ... 2.5 mm ²
Conductor cross section AWG / kcmil	24 ... 12
Conductor cross section flexible, with ferrule without plastic sleeve	0.25 mm ² ... 2.5 mm ²
Conductor cross section, flexible, with ferrule, with plastic sleeve	0.25 mm ² ... 2.5 mm ²
2 conductors with same cross section, solid	0.2 mm ² ... 1 mm ²
2 conductors with same cross section, flexible	0.2 mm ² ... 1.5 mm ²
2 conductors with same cross section, flexible, with ferrule without plastic sleeve	0.25 mm ² ... 1 mm ²
2 conductors with the same cross section, flexible, with TWIN ferrule with plastic sleeve	0.5 mm ² ... 1.5 mm ²
Cylindrical gauge a x b / diameter	2.8 mm x 2.0 mm / 2.4 mm
Stripping length	7 mm
Torque	0.5 Nm ... 0.6 Nm

Flange specifications

Type of locking	Screw locking
Mounting flange	Screw flange

Material data - contact

Note	WEEE/RoHS-compliant, free of whiskers according to IEC 60068-2-82/ JEDEC JESD 201
Contact material	Cu alloy
Surface characteristics	hot-dip tin-plated
Metal surface terminal point (top layer)	Tin (4 - 8 µm Sn)
Metal surface contact area (top layer)	Tin (4 - 8 µm Sn)

Material data - housing

Housing color	green (6021)
Insulating material	PA
Insulating material group	I
CTI according to IEC 60112	600
Flammability rating according to UL 94	V0

Printed-circuit board connector - MVSTBR 2,5/11-STF-5,08 EX - 1809762

Technical data

Material data - housing

Glow wire flammability index GWFI according to EN 60695-2-12	850
Glow wire ignition temperature GWIT according to EN 60695-2-13	775
Temperature for the ball pressure test according to EN 60695-10-2	125 °C

Dimensions for the product

Length [l]	12.6 mm
Width [w]	66.04 mm
Height [h]	26 mm
Pitch	5.08 mm
Height (without solder pin)	26 mm

Packaging information

Type of packaging	packed in cardboard
Pieces per package	50
Denomination packing units	Pcs.

Environmental Product Compliance

REACH SVHC	Lead 7439-92-1
China RoHS	Environmentally Friendly Use Period = 50 years
	For details about hazardous substances go to tab "Downloads", Category "Manufacturer's declaration"

Drawings

Printed-circuit board connector - MVSTBR 2,5/11-STF-5,08 EX - 1809762

Dimensional drawing

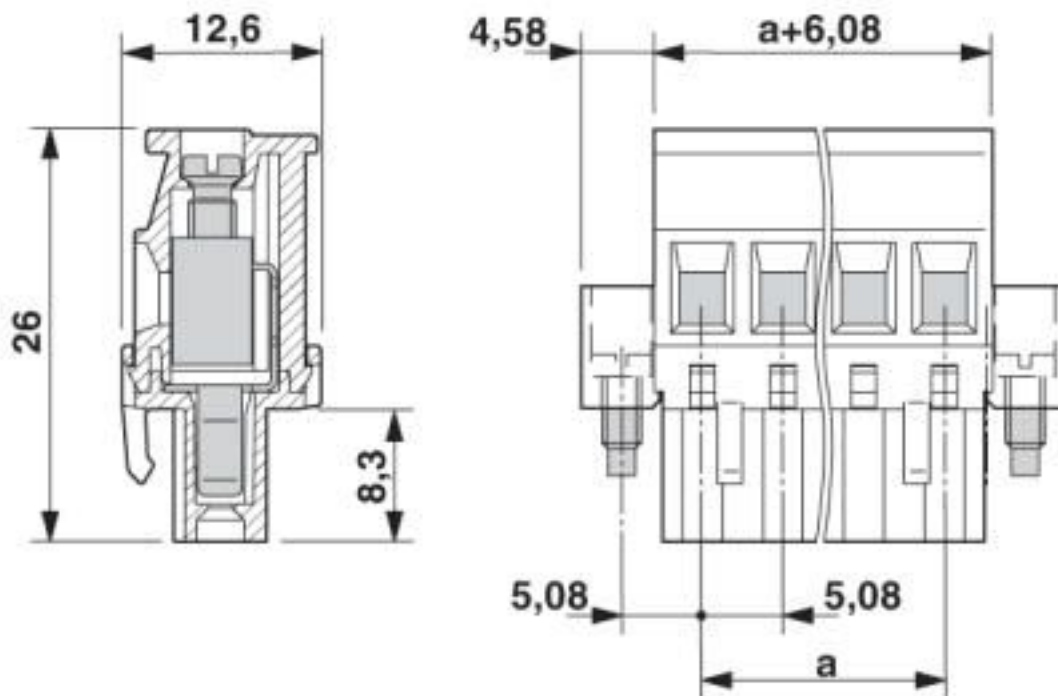

Classifications

eCl@ss

eCl@ss 10.0.1	27440309
eCl@ss 4.0	27260700
eCl@ss 4.1	27260700
eCl@ss 5.0	27260700
eCl@ss 5.1	27260700
eCl@ss 6.0	27260700
eCl@ss 7.0	27440309
eCl@ss 8.0	27440309
eCl@ss 9.0	27440309

ETIM

ETIM 3.0	EC001121
ETIM 4.0	EC002638
ETIM 5.0	EC002638
ETIM 6.0	EC002638
ETIM 7.0	EC002638

UNSPSC

UNSPSC 6.01	30211810
UNSPSC 7.0901	39121409

Printed-circuit board connector - MVSTBR 2,5/11-STF-5,08 EX - 1809762

Classifications

UNSPSC

UNSPSC 11	39121409
UNSPSC 12.01	39121409
UNSPSC 13.2	39121409
UNSPSC 18.0	39121409
UNSPSC 19.0	39121409
UNSPSC 20.0	39121409
UNSPSC 21.0	39121409

Accessories

Accessories

Coding element

Coding profile - CP-MSTB - 1734634



Coding profile, is inserted into the slot on the plug or inverted header, red insulating material

Labeled terminal marker

Marker card - SK 5,08/3,8:FORTL.ZAHLEN - 0804293



Marker card, Card, white, labeled, horizontal: consecutive numbers 1 ... 10, 11 ... 20, etc. up to 91 ... (99)100, mounting type: adhesive, for terminal block width: 5.08 mm, lettering field size: 5.08 x 3.8 mm

Marker pen

Marker pen - B-STIFT - 1051993



Marker pen, for manual labeling of unprinted Zack strips, smear-proof and waterproof, line thickness 0.5 mm

Screwdriver tools

Printed-circuit board connector - MVSTBR 2,5/11-STF-5,08 EX - 1809762

Accessories

Screwdriver - SZS 0,6X3,5 - 1205053



Actuation tool, for ST terminal blocks, insulated, also suitable for use as a bladed screwdriver, size: 0.6 x 3.5 x 100 mm, 2-component grip, with non-slip grip

Terminal marking

Marker card - SK 5,08/3,8:UNBEDRUCKT - 0805412



Marker card, Card, white, unlabeled, can be labeled with: Marker pen, mounting type: adhesive, for terminal block width: 5.08 mm, lettering field size: 5.08 x 3.8 mm

Test plug terminal block

Test plugs - MPS-MT - 0201744



Test plugs, with solder connection up to 1 mm² conductor cross section, color: gray

Reducing plug - RPS - 0201647



Reducing plug, color: gray

Additional products

Printed-circuit board connector - MSTB 2,5/11-GF-5,08 EX - 1795750

PCB headers, nominal current: 12 A, nominal cross section: 2.5 mm², number of positions: 11, pitch: 5.08 mm, color: green, contact surface: Tin, mounting: Wave soldering, pin layout: Linear pinning, solder pin [P]: 3.5 mm



Printed-circuit board connector - MVSTBR 2,5/11-STF-5,08 EX - 1809762

Accessories

Printed-circuit board connector - MSTBV 2,5/11-GF-5,08 EX - 1796416

PCB headers, nominal current: 12 A, nominal cross section: 2.5 mm², number of positions: 11, pitch: 5.08 mm, color: green, contact surface: Tin, mounting: Wave soldering, pin layout: Linear pinning, solder pin [P]: 3.9 mm



Phoenix Contact 2020 © - all rights reserved
<http://www.phoenixcontact.com>

PHOENIX CONTACT GmbH & Co. KG
Flachsmarktstr. 8
32825 Blomberg
Germany
Tel. +49 5235 300
Fax +49 5235 3 41200
<http://www.phoenixcontact.com>

X-ON Electronics

Largest Supplier of Electrical and Electronic Components

Click to view similar products for [Pluggable Terminal Blocks](#) category:

Click to view products by [Phoenix Contact](#) manufacturer:

Other Similar products are found below :

[57.510.0053](#) [MC 1.5/ 6-ST-3.5 GY AU](#) [734-104](#) [734-302](#) [8-141-P](#) [8426620000](#) [860505](#) [860810](#) [GBPACX-12](#) [93.731.4953.0](#) [PV05-5,08-K](#)
[PVP02-5,00](#) [PVP03-3,50](#) [PVP04-3,50](#) [PVS02-5,00](#) [1-1986160-3](#) [1377680000](#) [1531000000](#) [1546228-5](#) [ELFH16150](#) [ELFP03110](#)
[ELFP10210](#) [ELFT06250](#) [ELVP03100](#) [1700101](#) [1700410](#) [1700425](#) [1702246](#) [1705229](#) [1710175](#) [1714537](#) [1717806](#) [1719600](#) [1728941](#)
[1734692](#) [1734795](#) [1736036](#) [1740194](#) [1740291](#) [1740628](#) [1740990](#) [1746952](#) [1750207](#) [1752441](#) [1752865](#) [1754115](#) [1754144](#) [1756913](#)
[1760051](#) [1760336](#)