

# Printed-circuit board connector - MC 0,5/ 6-G-2,54 P20 THR R44 - 1821287

Please be informed that the data shown in this PDF Document is generated from our Online Catalog. Please find the complete data in the user's documentation. Our General Terms of Use for Downloads are valid (<http://phoenixcontact.com/download>)

PCB headers, nominal current: 6 A, rated voltage (III/2): 160 V, nominal cross section: 0.5 mm<sup>2</sup>, number of positions: 6, pitch: 2.54 mm, color: black, contact surface: Gold, mounting: THR soldering, pin layout: Linear pinning, solder pin [P]: 2 mm, Sample values available under SAMPLE MC...



The figure shows the 10-position version

## Your advantages

- Designed for integration into the SMT soldering process
- Additional solder anchors reduce the mechanical strain on the soldering spots
- Gold-plated contacts ensure transfer quality remains stable over the long term
- Supplied in tape-on-reel packing according to IEC 60286-3 for automated mounting



## Key Commercial Data

|                        |               |
|------------------------|---------------|
| Packing unit           | 465 pc        |
| Minimum order quantity | 465 pc        |
| GTIN                   |               |
| GTIN                   | 4046356789448 |

## Technical data

### Dimensions

|                          |                |
|--------------------------|----------------|
| Length [ l ]             | 7.1 mm         |
| Width                    | 19.82 mm       |
| Pitch                    | 2.54 mm        |
| Dimension a              | 12.7 mm        |
| Width [ w ]              | 19.82 mm       |
| Height [ h ]             | 6.85 mm        |
| Installed height         | 4.85 mm        |
| Length of the solder pin | 2 mm           |
| Pin dimensions           | 0.64 x 0.64 mm |

# Printed-circuit board connector - MC 0,5/ 6-G-2,54 P20 THR R44 - 1821287

## Technical data

### Dimensions

|             |         |
|-------------|---------|
| Pin spacing | 2.54 mm |
| Length      | 7.1 mm  |

### General

|  |                  |
|--|------------------|
| Range of articles                      | MC 0,5/...-G-THR |
| Insulating material group              | IIIa             |
| Rated surge voltage (III/3)            | 2.5 kV           |
| Rated surge voltage (III/2)            | 2.5 kV           |
| Rated surge voltage (II/2)             | 2.5 kV           |
| Rated voltage (III/3)                  | 32 V             |
| Rated voltage (III/2)                  | 160 V            |
| Rated voltage (II/2)                   | 160 V            |
| Connection in acc. with standard       | EN-VDE           |
| Nominal current I <sub>N</sub>         | 6 A              |
| Insulating material                    | LCP              |
| Flammability rating according to UL 94 | V0               |
| Color                                  | black            |
| Number of positions                    | 6                |

### Standards and Regulations

|  |        |
|--|--------|
| Connection in acc. with standard       | EN-VDE |
| Flammability rating according to UL 94 | V0     |

### Environmental Product Compliance

|            |   |
|------------|---|
| China RoHS | Environmentally friendly use period: unlimited = EFUP-e |
|            | No hazardous substances above threshold values          |

## Drawings

# Printed-circuit board connector - MC 0,5/ 6-G-2,54 P20 THR R44 - 1821287

Drilling diagram

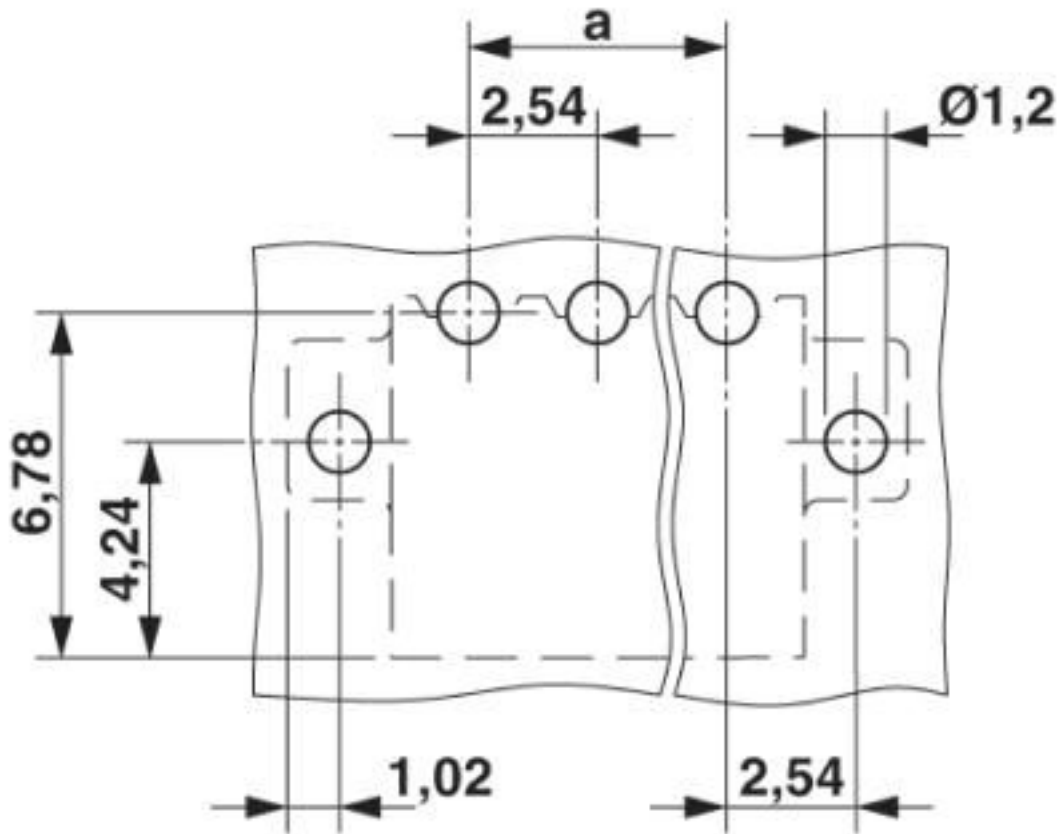

# Printed-circuit board connector - MC 0,5/ 6-G-2,54 P20 THR R44 - 1821287

Diagram

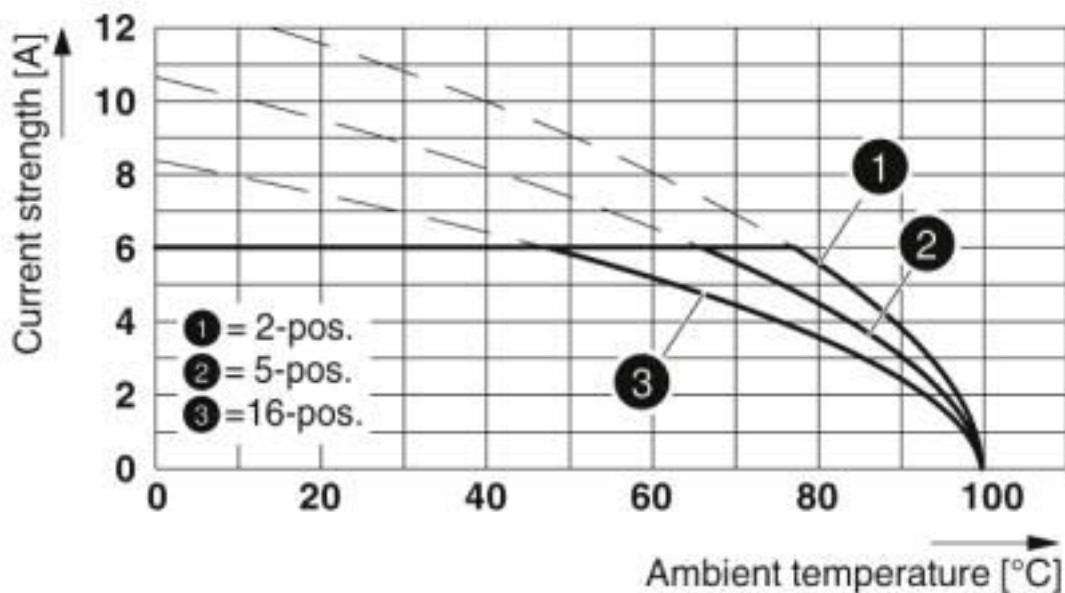

Type: FMC 0,5/...-ST-2,54 with MC 0,5/...-G-2,54 P20 THR R..

Diagram

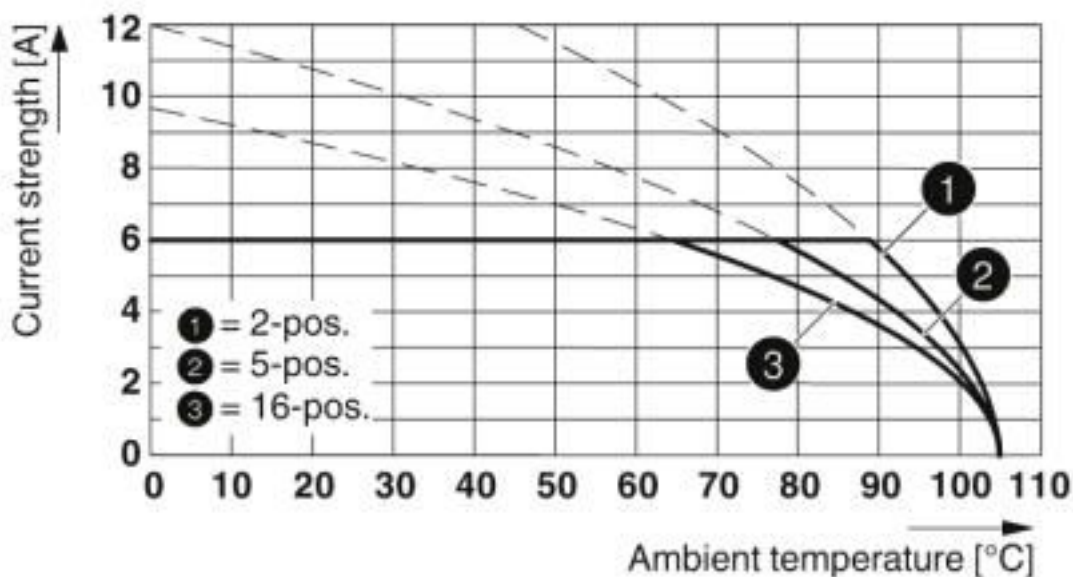

Type: MCC 0,5/...-ST-2,54 with MC 0,5/...-G-2,54 P20 THR R...

# Printed-circuit board connector - MC 0,5/ 6-G-2,54 P20 THR R44 - 1821287

Dimensional drawing

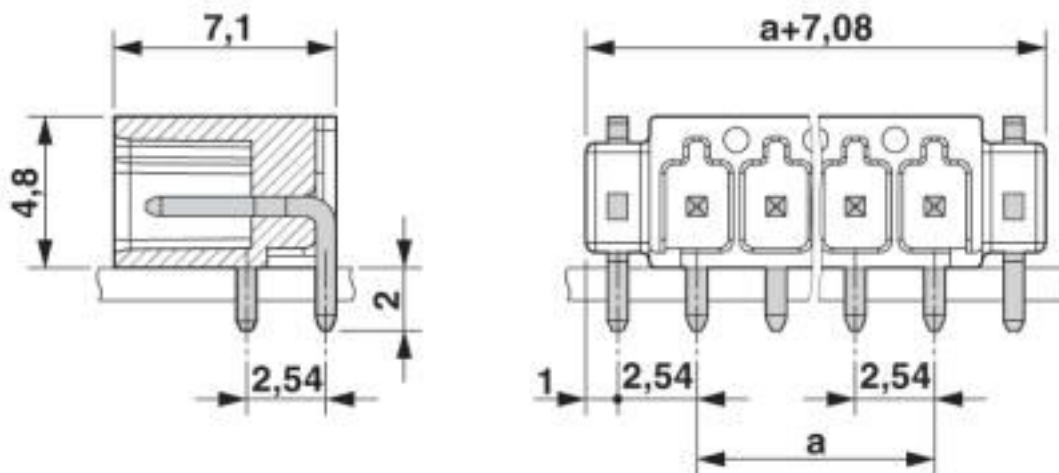

## Classifications

eCl@ss

|               |          |
|---------------|----------|
| eCl@ss 10.0.1 | 27440402 |
| eCl@ss 4.0    | 27260700 |
| eCl@ss 4.1    | 27260700 |
| eCl@ss 5.0    | 27260700 |
| eCl@ss 5.1    | 27260700 |
| eCl@ss 6.0    | 27260700 |
| eCl@ss 7.0    | 27440402 |
| eCl@ss 8.0    | 27440402 |
| eCl@ss 9.0    | 27440402 |

ETIM

|          |          |
|----------|----------|
| ETIM 3.0 | EC001121 |
| ETIM 4.0 | EC002637 |
| ETIM 5.0 | EC002637 |
| ETIM 6.0 | EC002637 |
| ETIM 7.0 | EC002637 |

UNSPSC

|               |          |
|---------------|----------|
| UNSPSC 6.01   | 30211810 |
| UNSPSC 7.0901 | 39121409 |
| UNSPSC 11     | 39121409 |
| UNSPSC 12.01  | 39121409 |
| UNSPSC 13.2   | 39121409 |
| UNSPSC 18.0   | 39121409 |
| UNSPSC 19.0   | 39121409 |

# Printed-circuit board connector - MC 0,5/ 6-G-2,54 P20 THR R44 - 1821287

## Classifications

### UNSPSC

|             |          |
|-------------|----------|
| UNSPSC 20.0 | 39121409 |
| UNSPSC 21.0 | 39121409 |

## Approvals

### Approvals

#### Approvals

IECEE CB Scheme / VDE Gutachten mit Fertigungsüberwachung / EAC / cULus Recognized

#### Ex Approvals

### Approval details

|                    |   |   |           |
|--------------------|---|---|-----------|
| IECEE CB Scheme    |  | <a href="http://www.iecee.org/">http://www.iecee.org/</a> | DE1-63595 |
| Nominal voltage UN | 160 V   |   |           |
| Nominal current IN | 6 A   |   |           |

|   |   |   |          |
|---|---|---|----------|
| VDE Gutachten mit Fertigungsüberwachung |  | <a href="http://www2.vde.com/de/Institut/Online-Service/VDE-gepruefteProdukte/Seiten/Online-Suche.aspx">http://www2.vde.com/de/Institut/Online-Service/VDE-gepruefteProdukte/Seiten/Online-Suche.aspx</a> | 40042258 |
| Nominal voltage UN                      | 160 V   |   |          |
| Nominal current IN                      | 6 A   |   |          |

|     |   |         |
|-----|---|---------|
| EAC |  | B.01687 |
|-----|---|---------|

|                    |   |   |                 |
|--------------------|---|---|-----------------|
| cULus Recognized   |  | <a href="http://database.ul.com/cgi-bin/XYV/template/LISEXT/1FRAME/index.htm">http://database.ul.com/cgi-bin/XYV/template/LISEXT/1FRAME/index.htm</a> | E60425-19920306 |
|                    | B   | C   |                 |
| Nominal voltage UN | 150 V   | 50 V  |                 |
| Nominal current IN | 6 A   | 6 A   |                 |

## Printed-circuit board connector - MC 0,5/ 6-G-2,54 P20 THR R44 - 1821287

### Accessories

#### Accessories

##### Labeled terminal marker

Marker card - SK 2,54/2,8:FORTL.ZAHLEN - 0804853



Marker card, Card, white, labeled, horizontal: consecutive numbers 1 ... 10, 11 ... 20, etc. up to 91 ... 99, mounting type: adhesive, for terminal block width: 2.54 mm, lettering field size: 2.54 x 2.8 mm

---

### PCB headers

Sample set - SAMPLE MC 0,5/ 6-G-2,54P20THR - 1706632



PCB headers, nominal current: 6 A, rated voltage (III/2): 160 V, nominal cross section: 0.5 mm<sup>2</sup>, number of positions: 6, pitch: 2.54 mm, color: black, contact surface: Gold, mounting: THR soldering, pin layout: Linear pinning, solder pin [P]: 2 mm

---

### Additional products

Printed-circuit board connector - FMC 0,5/ 6-ST-2,54 - 1821135



PCB connector, nominal current: 6 A, rated voltage (III/2): 160 V, nominal cross section: 0.5 mm<sup>2</sup>, number of positions: 6, pitch: 2.54 mm, connection method: Push-in spring connection, color: black, contact surface: Gold

---

Phoenix Contact 2020 © - all rights reserved  
<http://www.phoenixcontact.com>

PHOENIX CONTACT GmbH & Co. KG  
Flachsmarktstr. 8  
32825 Blomberg  
Germany  
Tel. +49 5235 300  
Fax +49 5235 3 41200  
<http://www.phoenixcontact.com>

## X-ON Electronics

Largest Supplier of Electrical and Electronic Components

*Click to view similar products for [Pluggable Terminal Blocks](#) category:*

*Click to view products by [Phoenix Contact](#) manufacturer:*

Other Similar products are found below :

[57.510.0053](#) [MC 1.5/ 6-ST-3.5 GY AU](#) [734-104](#) [734-302](#) [8-141-P](#) [8426620000](#) [860505](#) [860516](#) [860810](#) [GBPACX-12](#) [93.731.4953.0](#) [PV05-5,08-K](#) [PVP02-5,00](#) [PVP03-3,50](#) [PVP04-3,50](#) [PVS02-5,00](#) [1-1986160-3](#) [1377680000](#) [1531000000](#) [1546228-5](#) [ELFH16150](#) [ELFP03110](#) [ELFP10210](#) [ELFT06250](#) [ELVP03100](#) [1700101](#) [1700410](#) [1700425](#) [1702246](#) [1705229](#) [1710175](#) [1714537](#) [1717806](#) [1719600](#) [1728941](#) [1734692](#) [1734795](#) [1736036](#) [1740194](#) [1740291](#) [1740628](#) [1740990](#) [1746952](#) [1750207](#) [1752441](#) [1752865](#) [1754115](#) [1754144](#) [1756913](#) [1760051](#)