

# Printed-circuit board connector - SMC 1,5/ 5-G-3,81 - 1827305

Please be informed that the data shown in this PDF Document is generated from our Online Catalog. Please find the complete data in the user's documentation. Our General Terms of Use for Downloads are valid (<http://phoenixcontact.com/download>)

PCB headers, nominal current: 8 A, rated voltage (III/2): 160 V, nominal cross section: 1.5 mm<sup>2</sup>, number of positions: 5, pitch: 3.81 mm, color: green, contact surface: Tin, mounting: Wave soldering, pin layout: Linear pinning, solder pin [P]: 3.4 mm



The figure shows a 10-position version of the product

## Your advantages

- ✓ Well-known mounting principle allows worldwide use
- ✓ Angled connection enables multi-row arrangement on the PCB
- ✓ Maximum flexibility when it comes to device design – one header for connectors with different connection technologies



## Key Commercial Data

Packing unit	250 pc
Minimum order quantity	250 pc
GTIN	 4 017918 114428
GTIN	4017918114428

## Technical data

### Dimensions

Length [ l ]	13.1 mm
Width	20.44 mm
Pitch	3.81 mm
Dimension a	15.24 mm
Width [ w ]	20.44 mm
Height [ h ]	14.4 mm
Installed height	11 mm
Length of the solder pin	3.4 mm
Pin dimensions	0.8 x 0.8 mm
Length	13.1 mm

### General

## Printed-circuit board connector - SMC 1,5/ 5-G-3,81 - 1827305

### Technical data

#### General

Range of articles	SMC 1,5/...-G
Insulating material group	I
Rated surge voltage (III/3)	2.5 kV
Rated surge voltage (III/2)	2.5 kV
Rated surge voltage (II/2)	2.5 kV
Rated voltage (III/3)	160 V
Rated voltage (III/2)	160 V
Rated voltage (II/2)	320 V
Connection in acc. with standard	EN-VDE
Nominal current $I_N$	8 A
Maximum load current	8 A
Insulating material	PA
Flammability rating according to UL 94	V0
Color	green
Number of positions	5

#### Standards and Regulations

Connection in acc. with standard	EN-VDE
	CSA
Flammability rating according to UL 94	V0

#### Environmental Product Compliance

China RoHS	Environmentally friendly use period: unlimited = EFUP-e
	No hazardous substances above threshold values

### Drawings

# Printed-circuit board connector - SMC 1,5/ 5-G-3,81 - 1827305

Drilling diagram

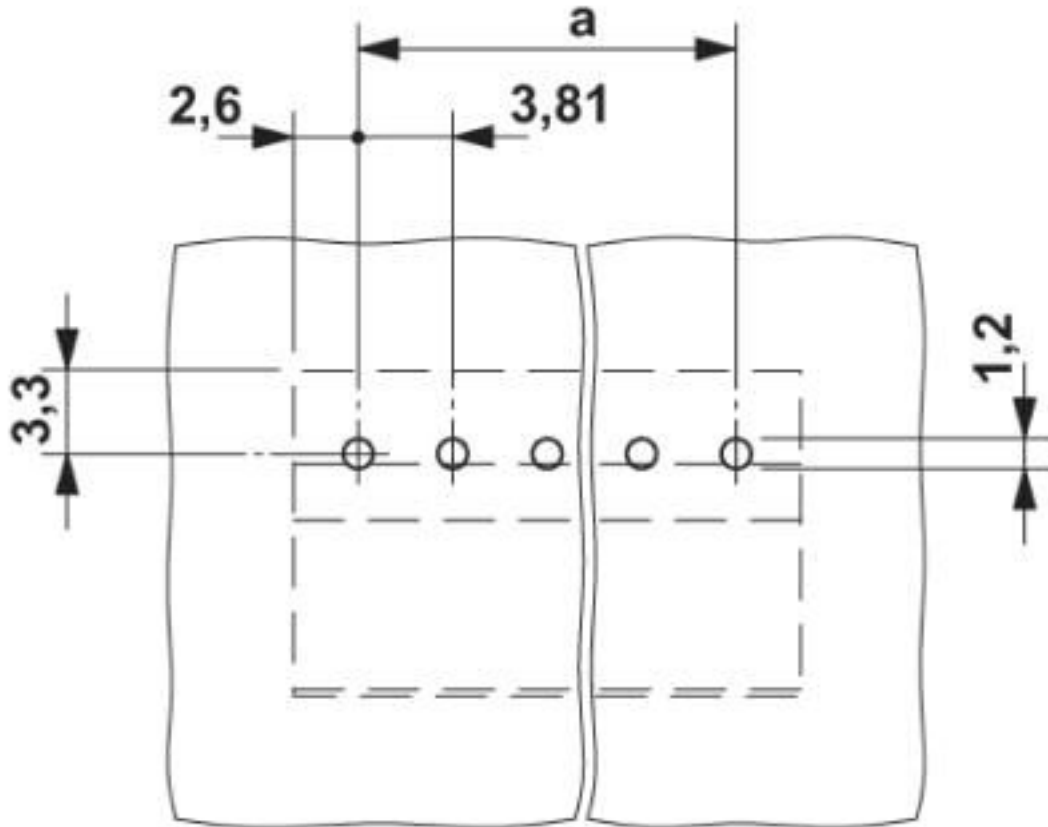

Diagram

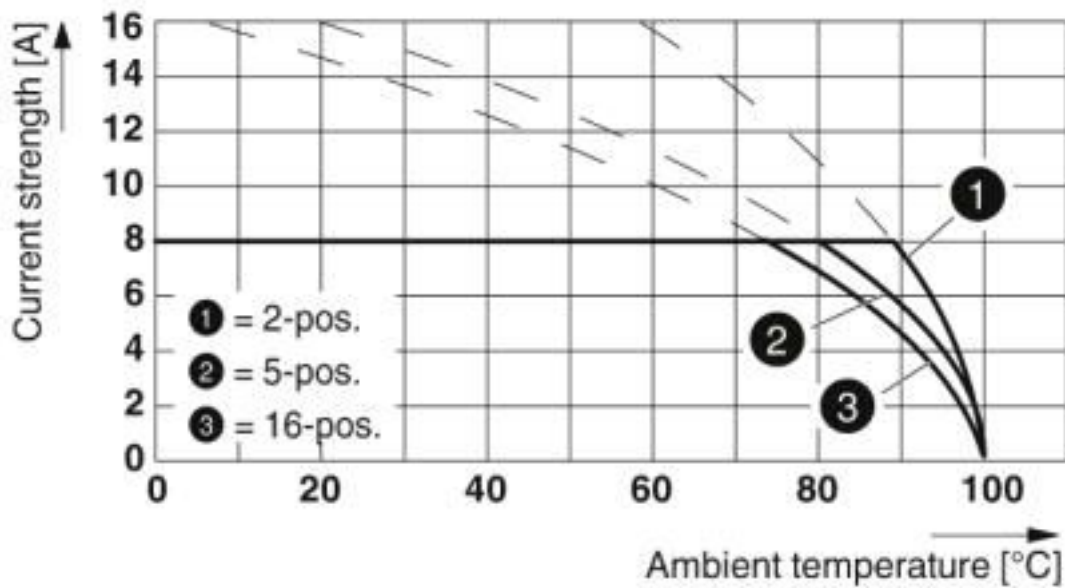

Type: FRONT-MC 1,5/...-ST-3,81 with SMC 1,5/...-G-3,81

# Printed-circuit board connector - SMC 1,5/ 5-G-3,81 - 1827305

Dimensional drawing

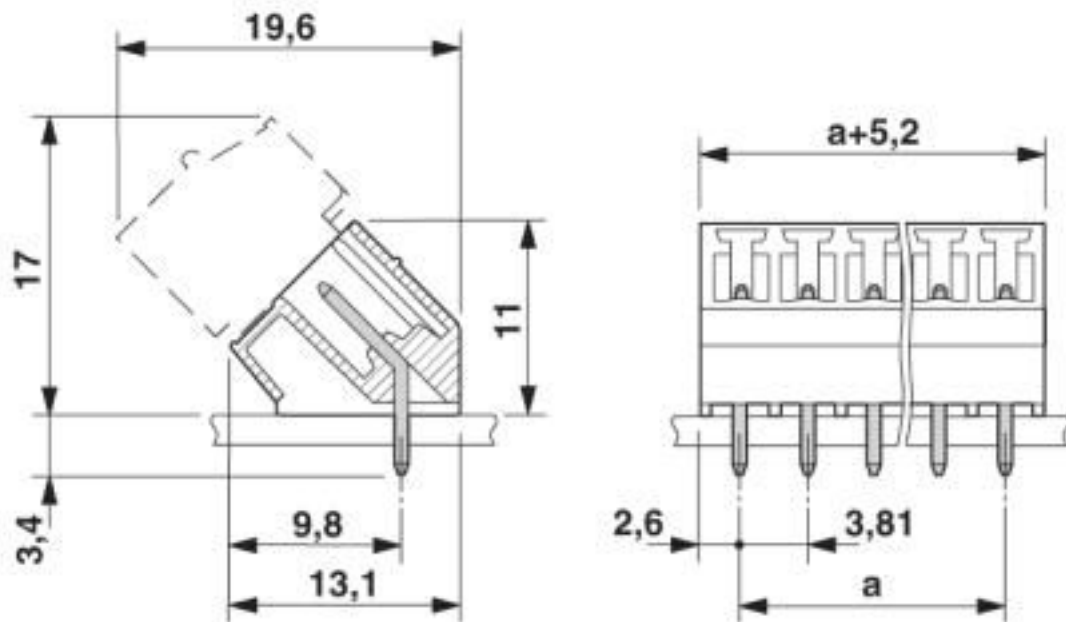

## Classifications

eCl@ss

eCl@ss 10.0.1	27440402
eCl@ss 4.0	27260700
eCl@ss 4.1	27260700
eCl@ss 5.0	27260700
eCl@ss 5.1	27260700
eCl@ss 6.0	27260700
eCl@ss 7.0	27440402
eCl@ss 8.0	27440402
eCl@ss 9.0	27440402

ETIM

ETIM 3.0	EC001121
ETIM 4.0	EC002637
ETIM 5.0	EC002637
ETIM 6.0	EC002637
ETIM 7.0	EC002637

UNSPSC

UNSPSC 6.01	30211810
UNSPSC 7.0901	39121409
UNSPSC 11	39121409
UNSPSC 12.01	39121409

# Printed-circuit board connector - SMC 1,5/ 5-G-3,81 - 1827305

## Classifications

### UNSPSC

UNSPSC 13.2	39121409
UNSPSC 18.0	39121409
UNSPSC 19.0	39121409
UNSPSC 20.0	39121409
UNSPSC 21.0	39121409

## Approvals

### Approvals

#### Approvals

CSA / IECCEB CB Scheme / VDE Gutachten mit Fertigungsüberwachung / EAC / cULus Recognized

#### Ex Approvals

### Approval details

CSA		<a href="http://www.csagroup.org/services-industries/product-listing/">http://www.csagroup.org/services-industries/product-listing/</a>	13631
	B	D	
Nominal voltage UN	300 V	300 V	
Nominal current IN	8 A	8 A	

IECEE CB Scheme		<a href="http://www.iecee.org/">http://www.iecee.org/</a>	DE1-60987-B1B2
Nominal voltage UN	160 V		
Nominal current IN	8 A		

VDE Gutachten mit Fertigungsüberwachung		<a href="http://www2.vde.com/de/Institut/Online-Service/VDE-gepruefteProdukte/Seiten/Online-Suche.aspx">http://www2.vde.com/de/Institut/Online-Service/VDE-gepruefteProdukte/Seiten/Online-Suche.aspx</a>	40011723
Nominal voltage UN	160 V		
Nominal current IN	8 A		

# Printed-circuit board connector - SMC 1,5/ 5-G-3,81 - 1827305

## Approvals

EAC		B.01687
-----	--	---------

cULus Recognized		<a href="http://database.ul.com/cgi-bin/XYV/template/LISEXT/1FRAME/index.htm">http://database.ul.com/cgi-bin/XYV/template/LISEXT/1FRAME/index.htm</a>	E60425-20110128
	B	D	
Nominal voltage UN	300 V	300 V	
Nominal current IN	8 A	8 A	

## Accessories

### Accessories

#### Coding element

Coding profile - CP-MSTB - 1734634



Coding profile, is inserted into the slot on the plug or inverted header, red insulating material

### Labeled terminal marker

Marker card - SK 3,81/2,8:FORTL.ZAHLEN - 0804109



Marker card, Card, white, labeled, horizontal: consecutive numbers 1 ... 10, 11 ... 20, etc. up to 91 ... (99)100, mounting type: adhesive, for terminal block width: 3.81 mm, lettering field size: 3.81 x 2.8 mm

### Marker pen

Marker pen - B-STIFT - 1051993



Marker pen, for manual labeling of unprinted Zack strips, smear-proof and waterproof, line thickness 0.5 mm

### Terminal marking

## Printed-circuit board connector - SMC 1,5/ 5-G-3,81 - 1827305

### Accessories

Marker card - SK U/2,8 WH:UNBEDRUCKT - 0803883

Marker card, Sheet, white, unlabeled, can be labeled with: PLOTMARK, CMS-P1-PLOTTER, Office printing systems, mounting type: adhesive, for terminal block width: 210 mm, lettering field size: 186 x 2.8 mm, Number of individual labels: 3600



---

### Additional products

Printed-circuit board connector - FMC 1,5/ 5-ST-3,81 - 1745920

PCB connector, nominal current: 8 A, rated voltage (III/2): 160 V, nominal cross section: 1.5 mm<sup>2</sup>, number of positions: 5, pitch: 3.81 mm, connection method: Push-in spring connection, color: green, contact surface: Tin



---

Printed-circuit board connector - MC 1,5/ 5-ST-3,81 - 1803604

PCB connector, nominal current: 8 A, rated voltage (III/2): 160 V, nominal cross section: 1.5 mm<sup>2</sup>, number of positions: 5, pitch: 3.81 mm, connection method: Screw connection with tension sleeve, color: green, contact surface: Tin



---

Printed-circuit board connector - MCVW 1,5/ 5-ST-3,81 - 1827004

PCB connector, nominal current: 8 A, rated voltage (III/2): 160 V, nominal cross section: 1.5 mm<sup>2</sup>, number of positions: 5, pitch: 3.81 mm, connection method: Screw connection with tension sleeve, color: green, contact surface: Tin



---

Printed-circuit board connector - MCVR 1,5/ 5-ST-3,81 - 1827156

PCB connector, nominal current: 8 A, rated voltage (III/2): 160 V, nominal cross section: 1.5 mm<sup>2</sup>, number of positions: 5, pitch: 3.81 mm, connection method: Screw connection with tension sleeve, color: green, contact surface: Tin



## Printed-circuit board connector - SMC 1,5/ 5-G-3,81 - 1827305

### Accessories

Printed-circuit board connector - FRONT-MC 1,5/ 5-ST-3,81 - 1850699



PCB connector, nominal current: 8 A, rated voltage (III/2): 160 V, nominal cross section: 1.5 mm<sup>2</sup>, number of positions: 5, pitch: 3.81 mm, connection method: Front screw connection, color: green, contact surface: Tin

Printed-circuit board connector - FK-MCP 1,5/ 5-ST-3,81 - 1851070



PCB connector, nominal current: 8 A, rated voltage (III/2): 160 V, nominal cross section: 1.5 mm<sup>2</sup>, number of positions: 5, pitch: 3.81 mm, connection method: Push-in spring connection, color: green, contact surface: Tin

Printed-circuit board connector - MCC 1/ 5-STZ-3,81 - 1852202



PCB connector, nominal current: 8 A, rated voltage (III/2): 160 V, nominal cross section: 1 mm<sup>2</sup>, number of positions: 5, pitch: 3.81 mm, connection method: Crimp connection, color: green, Corresponding female crimp contacts with current [A] and conductor cross section range [mm<sup>2</sup>] data: 5A/MCC-MT 0,2-0,35 (1859988); 8A/MCC-MT 0,5-1,0 (1859991)

Printed-circuit board connector - QC 0,5/ 5-ST-3,81 - 1897429



PCB connector, nominal current: 6 A, rated voltage (III/2): 200 V, nominal cross section: 0.5 mm<sup>2</sup>, number of positions: 5, pitch: 3.81 mm, connection method: Displacement connection, color: green, contact surface: Tin

Phoenix Contact 2020 © - all rights reserved  
<http://www.phoenixcontact.com>

PHOENIX CONTACT GmbH & Co. KG  
Flachsmarktstr. 8  
32825 Blomberg  
Germany  
Tel. +49 5235 300  
Fax +49 5235 3 41200  
<http://www.phoenixcontact.com>



## X-ON Electronics

Largest Supplier of Electrical and Electronic Components

*Click to view similar products for [Pluggable Terminal Blocks](#) category:*

*Click to view products by [Phoenix Contact](#) manufacturer:*

Other Similar products are found below :

[57.510.0053](#) [MC 1.5/ 6-ST-3.5 GY AU](#) [734-104](#) [734-302](#) [8-141-P](#) [8426620000](#) [860505](#) [860810](#) [GBPACX-12](#) [93.731.4953.0](#) [PV05-5,08-K](#)  
[PVP02-5,00](#) [PVP03-3,50](#) [PVP04-3,50](#) [PVS02-5,00](#) [1-1986160-3](#) [1377680000](#) [1531000000](#) [1546228-5](#) [ELFH16150](#) [ELFP03110](#)  
[ELFP10210](#) [ELFT06250](#) [ELVP03100](#) [1700101](#) [1700410](#) [1700425](#) [1702246](#) [1705229](#) [1710175](#) [1714537](#) [1717806](#) [1719600](#) [1728941](#)  
[1734692](#) [1734795](#) [1736036](#) [1740194](#) [1740291](#) [1740628](#) [1740990](#) [1746952](#) [1750207](#) [1752441](#) [1752865](#) [1754115](#) [1754144](#) [1756913](#)  
[1760051](#) [1760336](#)