

Cable housing - KGG-MC 1,5/ 8 - 1834408

Please be informed that the data shown in this PDF Document is generated from our Online Catalog. Please find the complete data in the user's documentation. Our General Terms of Use for Downloads are valid (<http://phoenixcontact.com/download>)



Cable housing, pitch: 3.81 mm, number of positions: 8, dimension a: 32.87 mm, color: green

RoHS

Key Commercial Data

Packing unit	10 pc
GTIN	
GTIN	4017918051921

Technical data

Dimensions

Width [w]	14.5 mm
Height [h]	45.6 mm
Pitch	3.81 mm
Dimension a	32.87 mm

General

Range of articles	KGG-MC 1,5
Number of positions	8
Insulating material group	I
Insulating material	ABS
Flammability rating according to UL 94	HB

Standards and Regulations

Flammability rating according to UL 94	HB
--	----

Environmental Product Compliance

China RoHS	Environmentally friendly use period: unlimited = EFUP-e
	No hazardous substances above threshold values

Cable housing - KGG-MC 1,5/ 8 - 1834408

Drawings

Dimensional drawing

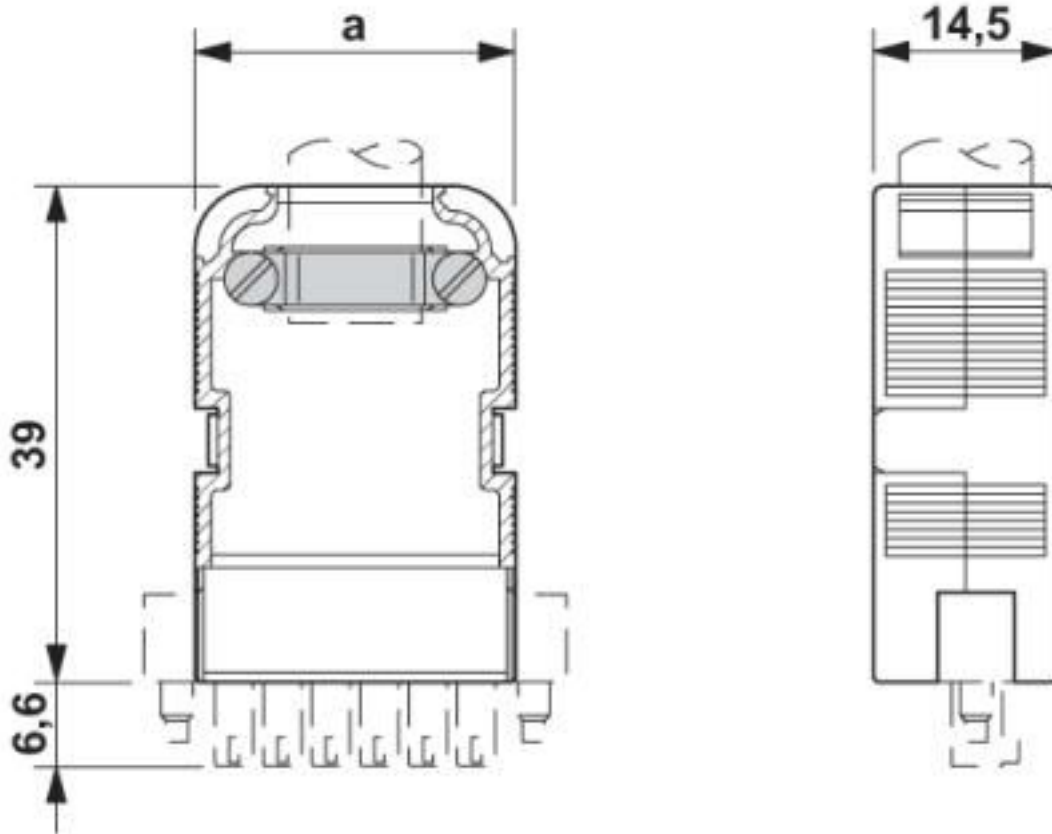

Classifications

eCl@ss

eCl@ss 10.0.1	27440392
eCl@ss 4.0	27260700
eCl@ss 4.1	27260700
eCl@ss 5.0	27260700
eCl@ss 5.1	27261200
eCl@ss 6.0	27261200
eCl@ss 7.0	27440202
eCl@ss 8.0	27440390
eCl@ss 9.0	27440392

ETIM

ETIM 3.0	EC001121
ETIM 4.0	EC000879
ETIM 5.0	EC000437

Cable housing - KGG-MC 1,5/ 8 - 1834408

Classifications

ETIM

ETIM 6.0	EC000437
ETIM 7.0	EC000437

UNSPSC

UNSPSC 6.01	30211810
UNSPSC 7.0901	39121409
UNSPSC 11	39121409
UNSPSC 12.01	39121409
UNSPSC 13.2	31261501
UNSPSC 18.0	31261501
UNSPSC 19.0	31261501
UNSPSC 20.0	31261501
UNSPSC 21.0	31261501

Approvals

Approvals

Approvals

EAC

Ex Approvals

Approval details

EAC		B.01687
-----	--	---------

Accessories

Accessories

Cable housing

Marking material - KGG-MC 1,5/ DST - 1839050



Transparent label carrier, can be marked with marker strips SBS 10

Cable housing - KGG-MC 1,5/ 8 - 1834408

Accessories

Sleeve housings

Bend protection sleeve - CUC-DST-ABK-CP7,5 - 1419794



Bend protection sleeve, degree of protection: IP20, color: black

Bend protection sleeve - CUC-DST-ABK-CP9 - 1419792



Bend protection sleeve, degree of protection: IP20, color: black

Bend protection sleeve - CUC-DST-ABK-CP9,7 - 1419793



Bend protection sleeve, degree of protection: IP20, color: black

Terminal marking

Marker card - SBS10:UNBEDRUCKT - 1007248



Marker card, Card, white, unlabeled, can be labeled with: Marker pen, perforated, mounting type: snap into tall marker groove, snap into flat marker groove, for terminal block width: 10 mm, lettering field size: 6 x 10.1 mm, Number of individual labels: 250

X-ON Electronics

Largest Supplier of Electrical and Electronic Components

Click to view similar products for [Terminal Block Tools & Accessories](#) category:

Click to view products by [Phoenix Contact](#) manufacturer:

Other Similar products are found below :

[00171430102](#) [00171420102](#) [600HL](#) [600RJ-07](#) [600RJ-11](#) [600RJ-14](#) [600RJS-10](#) [600RJS-12](#) [600RJS-15](#) [600RJS-21](#) [601RJ-09](#) [602SP](#) [602Z](#)
[604J](#) [CSTSPC1-2](#) [7B941-7](#) [88943-2100](#) [QC102](#) [1437403-6](#) [1437403-9](#) [1437403-8](#) [1453128-1](#) [147832-1](#) [EC0037-000](#) [MT2/H--](#) [MT6/H-N](#)
[MT6/V-GRND](#) [MT8/H-51-60](#) [BC2-12](#) [BCC-1-8/10](#) [EP2.5/4UN/BG](#) [1707755](#) [1735590](#) [1755480](#) [1789281](#) [1840227](#) [1840230](#) [2-1437402-1](#)
[JA2-03](#) [JB1-03/J](#) [JB2-04](#) [JB2-05](#) [JB2-07](#) [JB2-09/J](#) [PARALLELJUMPERLINK](#) [JS601](#) [2204082](#) [2302463](#) [2305949](#) [8PCV-BUSHING](#)