

## Feed-through header - MC 1,5/ 6-G-3,5 - 1844252

Please be informed that the data shown in this PDF Document is generated from our Online Catalog. Please find the complete data in the user's documentation. Our General Terms of Use for Downloads are valid (<http://phoenixcontact.com/download>)

PCB headers, nominal current: 8 A, rated voltage (III/2): 160 V, nominal cross section: 1.5 mm<sup>2</sup>, number of positions: 6, pitch: 3.5 mm, color: green, contact surface: Tin, mounting: Wave soldering, pin layout: Linear pinning, solder pin [P]: 3.4 mm



The figure shows a 10-position version of the product

### Your advantages

- ✓ Well-known mounting principle allows worldwide use
- ✓ Maximum flexibility when it comes to device design – one header for connectors with different connection technologies



### Key Commercial Data

Packing unit	100 pc
GTIN	 4 017918 113292
GTIN	4017918113292

### Technical data

#### Item properties

Brief article description	Feed-through header
Plug-in system	MINI COMBICON
Type of contact	Male connector
Range of articles	MC 1,5/...-G
Pitch	3.5 mm
Number of positions	6
Mounting type	Wave soldering
Pin layout	Linear pinning
Locking	without
Number of levels	1
Number of connections	6
Number of potentials	6

# Feed-through header - MC 1,5/ 6-G-3,5 - 1844252

## Technical data

### Electrical parameters

Nominal current	8 A
Nom. voltage	160 V
Rated voltage	160 V
Rated voltage (III/2)	160 V
Rated voltage (II/2)	250 V
Rated surge voltage (III/3)	2.5 kV
Rated surge voltage (III/2)	2.5 kV
Rated surge voltage (II/2)	2.5 kV

### Material data - contact

Note	WEEE/RoHS-compliant, free of whiskers according to IEC 60068-2-82/ JEDEC JESD 201
Contact material	Cu alloy
Surface characteristics	Tin-plated
Metal surface contact area (top layer)	Tin (3 - 5 µm Sn)
Metal surface contact area (middle layer)	Nickel (1.3 - 3 µm Ni),
Metal surface soldering area (top layer)	Tin (3 - 5 µm Sn)
Metal surface soldering area (middle layer)	Nickel (1.3 - 3 µm Ni)

### Material data - housing

Housing color	green (6021)
Insulating material	PBT
Insulating material group	IIIa
CTI according to IEC 60112	225
Flammability rating according to UL 94	V0

### Dimensions for the product

Length [ l ]	9.2 mm
Width [ w ]	22.4 mm
Height [ h ]	10.65 mm
Pitch	3.5 mm
Height (without solder pin)	7.25 mm
Solder pin [P]	3.4 mm
Pin dimensions	0.8 x 0.8 mm

### Dimensions for PCB design

Hole diameter	1.2 mm
---------------	--------

### Packaging information

Type of packaging	packed in cardboard
Pieces per package	100
Denomination packing units	Pcs.

### Ambient conditions

# Feed-through header - MC 1,5/ 6-G-3,5 - 1844252

## Technical data

### Ambient conditions

Ambient temperature (storage/transport)	-40 °C ... 70 °C
Ambient temperature (assembly)	-5 °C ... 100 °C
Ambient temperature (operation)	-40 °C ... 100 °C (dependent on the derating curve)

### Air clearances and creepage distances

Clearances and creepage distances	IEC 60664-1:2007-04
Specification	IEC 60664-1:2007-04
Minimum clearance - inhomogeneous field (III/3)	1.5 mm
Minimum clearance - inhomogeneous field (III/2)	1.5 mm
Minimum clearance - inhomogeneous field (II/2)	1.5 mm
Minimum creepage distance value (III/3)	2.5 mm
Minimum creepage distance value (III/2)	1.6 mm
Minimum creepage distance value (II/2)	2.5 mm

### Mechanical tests (A)

Test specification	IEC 61984
Insertion strength per pos. approx.	6 N
Withdraw strength per pos. approx.	4 N
Polarization when inserted requirement >20 N	Test passed
Contact holder in insert requirements >20 N	Test passed

### Durability tests (B)

Specification	IEC 60512-9-1:2010-03
Contact resistance R <sub>1</sub>	1.3 mΩ
Insertion/withdrawal cycles	25
Contact resistance R <sub>2</sub>	1.4 mΩ
Impulse withstand voltage at sea level	2.95 kV
Power-frequency withstand voltage	1.39 kV
Insulation resistance, neighboring positions	> 1.6 TΩ

### Thermal tests (C)

Specification	IEC 60512-5-1:2002-02
Number of positions	20
Conductor cross section	1.5 mm <sup>2</sup>
Test current	8 A DC
Upper limiting temperature requirements <100 °C	Test passed

### Climatic tests (D)

Specification	ISO 6988:1985-02
Cold stress	-40 °C/2 h
Thermal stress	100 °C/168 h
Corrosive stress	0.2 dm <sup>3</sup> SO <sub>2</sub> on 300 dm <sup>3</sup> /40 °C/1 cycle
Impulse withstand voltage at sea level	2.95 kV

## Feed-through header - MC 1,5/ 6-G-3,5 - 1844252

### Technical data

#### Climatic tests (D)

Power-frequency withstand voltage	1.39 kV
-----------------------------------	---------

#### Environmental and durability tests (E)

Specification	IEC 61984:2008-10
Result, degree of protection, IP code	Finger safety with IP20 test finger

#### Vibration test

Specification	IEC 60068-2-6:2007-12
Result	Test passed
Frequency	10 - 150 - 10 Hz
Sweep speed	1 octave/min
Amplitude	0.35 mm (10 - 60.1 Hz)
Acceleration	5 g (60.1 - 150 Hz)
Test duration per axis	2.5 h

#### Standards and Regulations

Connection in acc. with standard	EN-VDE
	CSA
Flammability rating according to UL 94	V0

#### Environmental Product Compliance

China RoHS	Environmentally friendly use period: unlimited = EFUP-e
	No hazardous substances above threshold values

### Drawings

# Feed-through header - MC 1,5/ 6-G-3,5 - 1844252

Drilling diagram

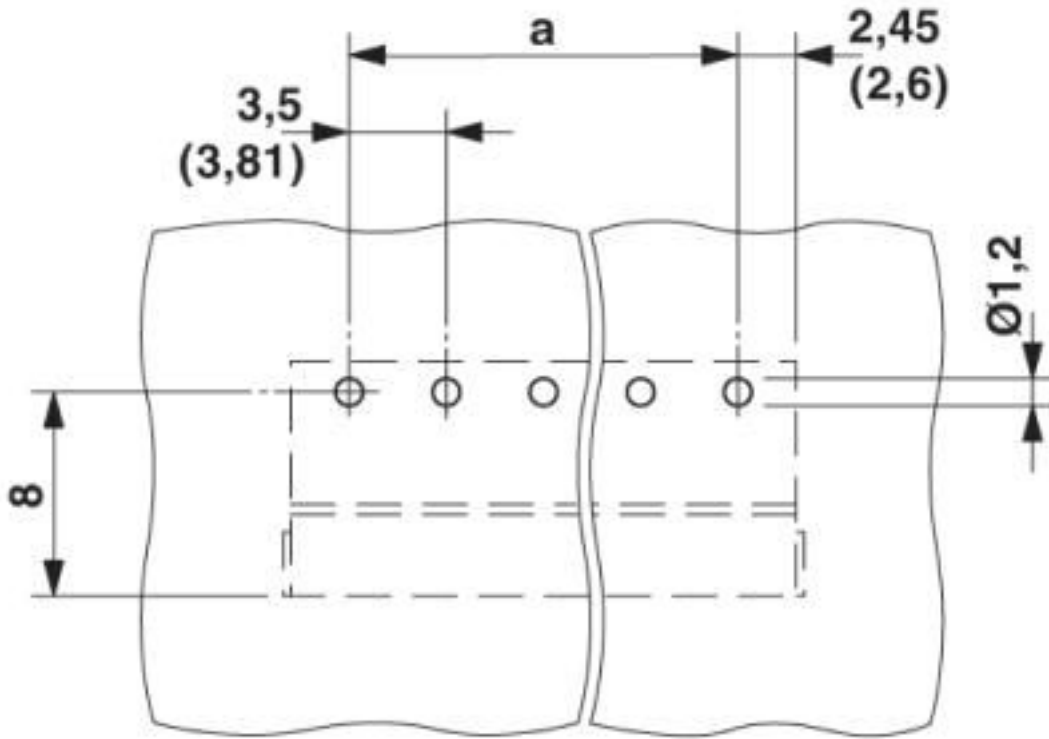

Diagram

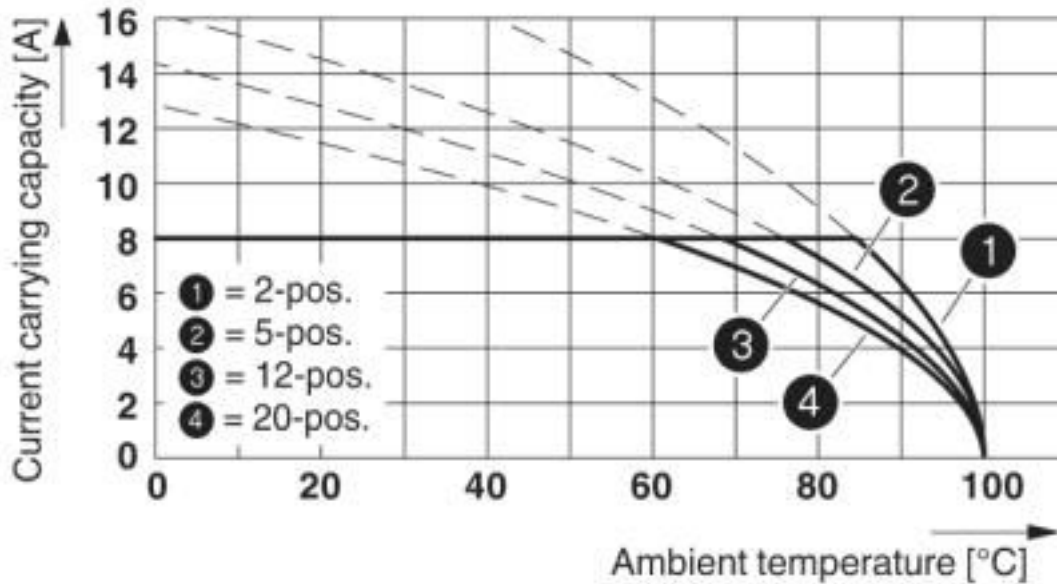

# Feed-through header - MC 1,5/ 6-G-3,5 - 1844252

Diagram

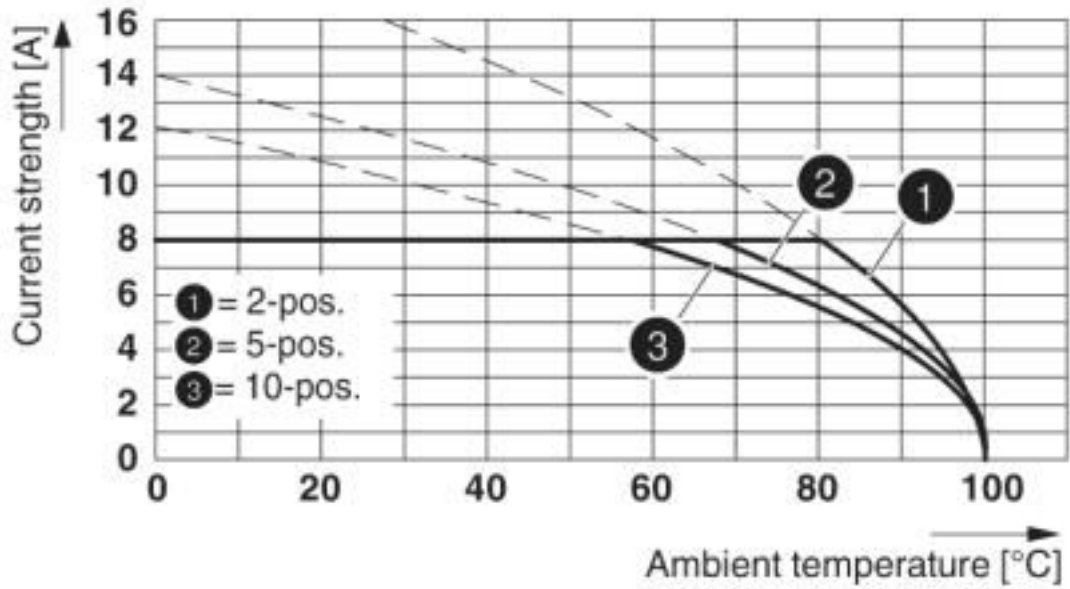

Type: TFMC 1,5/...-ST-3,5 with MC 1,5/...-G-3,5

Diagram

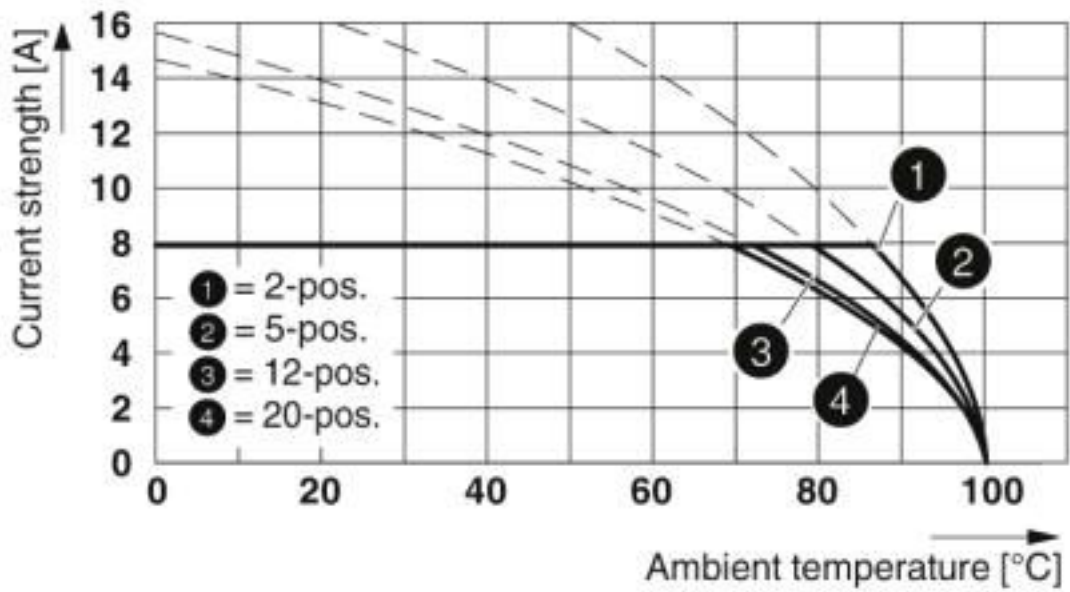

Type: MC 1,5/...-ST-3,5 with MC 1,5/...-G-3,5

# Feed-through header - MC 1,5/ 6-G-3,5 - 1844252

Diagram

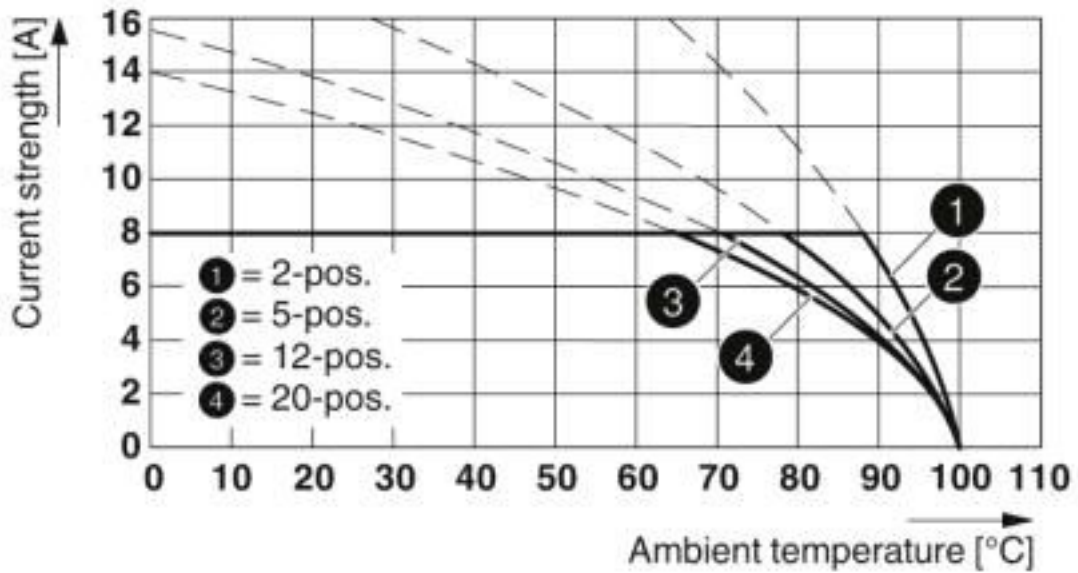

Type: FK-MCP 1,5/...-ST-3,5 with MC 1,5/...-G-3,5

Diagram

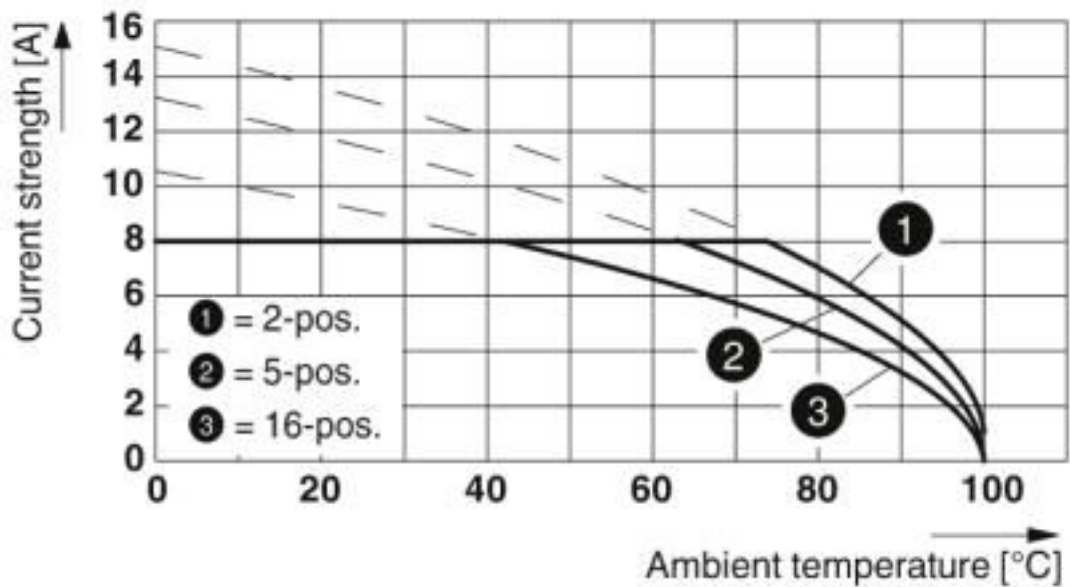

Type: MCVW 1,5/...-ST-3,5 with MC 1,5/...-G-3,5

## Feed-through header - MC 1,5/ 6-G-3,5 - 1844252

Dimensional drawing

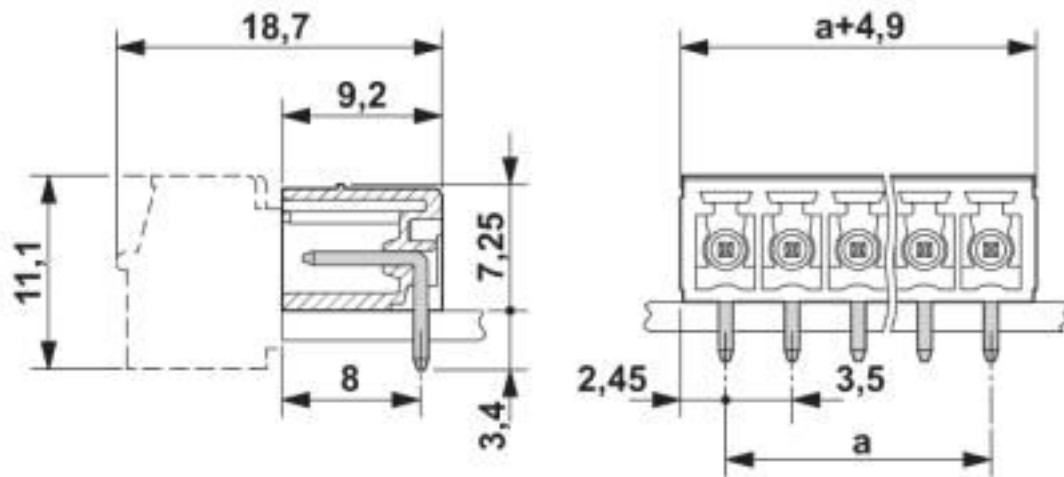

### Classifications

#### eCl@ss

eCl@ss 10.0.1	27440402
eCl@ss 4.0	27260700
eCl@ss 4.1	27260700
eCl@ss 5.0	27260700
eCl@ss 5.1	27260700
eCl@ss 6.0	27260700
eCl@ss 7.0	27440402
eCl@ss 8.0	27440402
eCl@ss 9.0	27440402

#### ETIM

ETIM 3.0	EC001121
ETIM 4.0	EC002637
ETIM 5.0	EC002637
ETIM 6.0	EC002637
ETIM 7.0	EC002637

#### UNSPSC

UNSPSC 6.01	30211810
UNSPSC 7.0901	39121409
UNSPSC 11	39121409
UNSPSC 12.01	39121409
UNSPSC 13.2	39121409
UNSPSC 18.0	39121409
UNSPSC 19.0	39121409
UNSPSC 20.0	39121409



# Feed-through header - MC 1,5/ 6-G-3,5 - 1844252

## Classifications

### UNSPSC

UNSPSC 21.0	39121409
-------------	----------

## Approvals

### Approvals

### Approvals

CSA / IECCEB CB Scheme / VDE Gutachten mit Fertigungsüberwachung / EAC / cULus Recognized

### Ex Approvals

## Approval details

CSA		<a href="http://www.csagroup.org/services-industries/product-listing/">http://www.csagroup.org/services-industries/product-listing/</a>	13631
		B	D
Nominal voltage UN		300 V	300 V
Nominal current IN		8 A	8 A

IECEE CB Scheme		<a href="http://www.iecee.org/">http://www.iecee.org/</a>	DE1-60987-B1B2
Nominal voltage UN		160 V	
Nominal current IN		8 A	

VDE Gutachten mit Fertigungsüberwachung		<a href="http://www2.vde.com/de/Institut/Online-Service/VDE-gepruefteProdukte/Seiten/Online-Suche.aspx">http://www2.vde.com/de/Institut/Online-Service/VDE-gepruefteProdukte/Seiten/Online-Suche.aspx</a>	40011723
Nominal voltage UN		160 V	
Nominal current IN		8 A	

EAC			B.01687
-----	---	--	---------

# Feed-through header - MC 1,5/ 6-G-3,5 - 1844252

## Approvals

cULus Recognized		<a href="http://database.ul.com/cgi-bin/XYV/template/LISEXT/1FRAME/index.htm">http://database.ul.com/cgi-bin/XYV/template/LISEXT/1FRAME/index.htm</a>	E60425-20110128
	B	D	
Nominal voltage UN	300 V	300 V	
Nominal current IN	8 A	8 A	

## Accessories

### Accessories

#### Coding element

Coding profile - CP-MSTB - 1734634

Coding profile, is inserted into the slot on the plug or inverted header, red insulating material



### Fiber optic

Fiber optic - MC 1,5/10-LWL 1,5-3,5 - 1841161

MINI COMBICON fiber optics, 3.5 mm pitch, 10-pos., separable for other numbers of positions (minimum: 2-pos.), inserts into the back of the MC header, color: transparent, dimension a: 1.5 mm



Fiber optic - MC 1,5/10-LWL 2,3-3,5 - 1841187

MINI COMBICON fiber optics, 3.5 mm pitch, 10-pos., separable for other numbers of positions (minimum: 2-pos.), inserts into the back of the MC header, color: transparent, dimension a: 2.3 mm



Fiber optic - MC 1,5/10-LWL 4-3,5 - 1841200

MINI COMBICON fiber optics, 3.5 mm pitch, 10-pos., separable for other numbers of positions (minimum: 2-pos.), inserts into the back of the MC header, color: transparent, dimension a: 4 mm



## Feed-through header - MC 1,5/ 6-G-3,5 - 1844252

### Accessories

#### Labeled terminal marker

Marker card - SK 3,5/2,8:FORTL.ZAHLEN - 0804073



Marker card, Card, white, labeled, horizontal: consecutive numbers 1 ... 10, 11 ... 20, etc. up to 91 ... 99, mounting type: adhesive, for terminal block width: 3.5 mm, lettering field size: 3.5 x 2.8 mm

---

### Additional products

Printed-circuit board connector - TFMC 1,5/ 6-ST-3,5 - 1772650



PCB connector, nominal current: 8 A, rated voltage (III/2): 160 V, nominal cross section: 1.5 mm<sup>2</sup>, number of positions: 6, pitch: 3.5 mm, connection method: Push-in spring connection, color: green, contact surface: Tin

---

Printed-circuit board connector - MC 1,5/ 6-ST-3,5 - 1840405



PCB connector, nominal current: 8 A, rated voltage (III/2): 160 V, nominal cross section: 1.5 mm<sup>2</sup>, number of positions: 6, pitch: 3.5 mm, connection method: Screw connection with tension sleeve, color: green, contact surface: Tin

---

Printed-circuit board connector - MCVW 1,5/ 6-ST-3,5 - 1862894



PCB connector, nominal current: 8 A, rated voltage (III/2): 160 V, nominal cross section: 1.5 mm<sup>2</sup>, number of positions: 6, pitch: 3.5 mm, connection method: Screw connection with tension sleeve, color: green, contact surface: Tin

---

Printed-circuit board connector - MCVR 1,5/ 6-ST-3,5 - 1863194



PCB connector, nominal current: 8 A, rated voltage (III/2): 160 V, nominal cross section: 1.5 mm<sup>2</sup>, number of positions: 6, pitch: 3.5 mm, connection method: Screw connection with tension sleeve, color: green, contact surface: Tin

## Feed-through header - MC 1,5/ 6-G-3,5 - 1844252

### Accessories

Printed-circuit board connector - FK-MCP 1,5/ 6-ST-3,5 - 1939950



PCB connector, nominal current: 8 A, rated voltage (III/2): 160 V, nominal cross section: 1.5 mm<sup>2</sup>, number of positions: 6, pitch: 3.5 mm, connection method: Push-in spring connection, color: green, contact surface: Tin

---

Printed-circuit board connector - FMC 1,5/ 6-ST-3,5 - 1952306



PCB connector, nominal current: 8 A, rated voltage (III/2): 160 V, nominal cross section: 1.5 mm<sup>2</sup>, number of positions: 6, pitch: 3.5 mm, connection method: Push-in spring connection, color: green, contact surface: Tin

---

Phoenix Contact 2020 © - all rights reserved  
<http://www.phoenixcontact.com>

PHOENIX CONTACT GmbH & Co. KG  
Flachsmarktstr. 8  
32825 Blomberg  
Germany  
Tel. +49 5235 300  
Fax +49 5235 3 41200  
<http://www.phoenixcontact.com>

## X-ON Electronics

Largest Supplier of Electrical and Electronic Components

*Click to view similar products for [Pluggable Terminal Blocks](#) category:*

*Click to view products by [Phoenix Contact](#) manufacturer:*

Other Similar products are found below :

[57.510.0053](#) [MC 1.5/ 6-ST-3.5 GY AU](#) [734-104](#) [734-302](#) [8-141-P](#) [8426620000](#) [860505](#) [860516](#) [860810](#) [GBPACX-12](#) [93.731.4953.0](#) [PV05-5,08-K](#) [PVP02-5,00](#) [PVP03-3,50](#) [PVP04-3,50](#) [PVS02-5,00](#) [1-1986160-3](#) [1377680000](#) [1531000000](#) [1546228-5](#) [ELFH16150](#) [ELFP03110](#) [ELFP10210](#) [ELFT06250](#) [ELVP03100](#) [1700101](#) [1700410](#) [1700425](#) [1702246](#) [1705229](#) [1710175](#) [1714537](#) [1717806](#) [1719600](#) [1728941](#) [1734692](#) [1734795](#) [1736036](#) [1740194](#) [1740291](#) [1740628](#) [1740990](#) [1746952](#) [1750207](#) [1752441](#) [1752865](#) [1754115](#) [1754144](#) [1756913](#) [1760051](#)