

Printed-circuit board connector - MCC 1/15-STZF-3,81 - 1852493

Please be informed that the data shown in this PDF Document is generated from our Online Catalog. Please find the complete data in the user's documentation. Our General Terms of Use for Downloads are valid (<http://phoenixcontact.com/download>)

PCB connector, nominal current: 8 A, rated voltage (III/2): 160 V, nominal cross section: 1 mm², number of positions: 15, pitch: 3.81 mm, connection method: Crimp connection, color: green, Corresponding female crimp contacts with current [A] and conductor cross section range [mm²] data: 5A/MCC-MT 0,2-0,35 (1859988); 8A/MCC-MT 0,5-1,0 (1859991)



The figure shows an 10-position version

Your advantages

- Inexpensive connection of large quantities of pre-assembled conductors
- Screwable flange for superior mechanical stability
- Pull-out aid facilitates handling and allows the tensile force to be reduced at the contact point



Key Commercial Data

Packing unit	50 pc
GTIN	 4 017918 144005
GTIN	4017918144005

Technical data

Item properties

Brief article description	Printed-circuit board connector
Plug-in system	MINI COMBICON
Type of contact	Female connector
Range of articles	MCC 1/..-STZF
Pitch	3.81 mm
Number of positions	15
Connection method	Crimp connection
Locking	Screw flange
Number of levels	1
Number of connections	15
Number of potentials	15

Electrical parameters

Printed-circuit board connector - MCC 1/15-STZF-3,81 - 1852493

Technical data

Electrical parameters

Nominal current	8 A
Nom. voltage	160 V
Rated voltage	160 V
Rated voltage (III/2)	160 V
Rated voltage (II/2)	320 V
Rated surge voltage (III/3)	2.5 kV
Rated surge voltage (III/2)	2.5 kV
Rated surge voltage (II/2)	2.5 kV

Connection capacity

Connection method	Crimp connection
pluggable	Yes
Conductor cross section flexible	0.2 mm ² ... 1 mm ²
Conductor cross section AWG / kcmil	24 ... 18

Flange specifications

Type of locking	Screw locking
Mounting flange	Screw flange

Material data - contact

Note	WEEE/RoHS-compliant, free of whiskers according to IEC 60068-2-82/ JEDEC JESD 201
Contact material	Cu alloy
Metal surface terminal point (top layer)	Tin (Sn)
Metal surface contact area (top layer)	Tin (Sn)

Material data - housing

Housing color	green (6021)
Insulating material	PA
Insulating material group	I
CTI according to IEC 60112	600
Flammability rating according to UL 94	V0
Glow wire flammability index GWFI according to EN 60695-2-12	850
Glow wire ignition temperature GWIT according to EN 60695-2-13	775
Temperature for the ball pressure test according to EN 60695-10-2	125 °C

Dimensions for the product

Length [l]	23.1 mm
Width [w]	67.54 mm
Height [h]	8.7 mm
Pitch	3.81 mm
Height (without solder pin)	8.7 mm

Packaging information

Printed-circuit board connector - MCC 1/15-STZF-3,81 - 1852493

Technical data

Packaging information

Type of packaging	packed in cardboard
Pieces per package	50
Denomination packing units	Pcs.

Environmental Product Compliance

China RoHS	Environmentally friendly use period: unlimited = EFUP-e
	No hazardous substances above threshold values

Drawings

Diagram

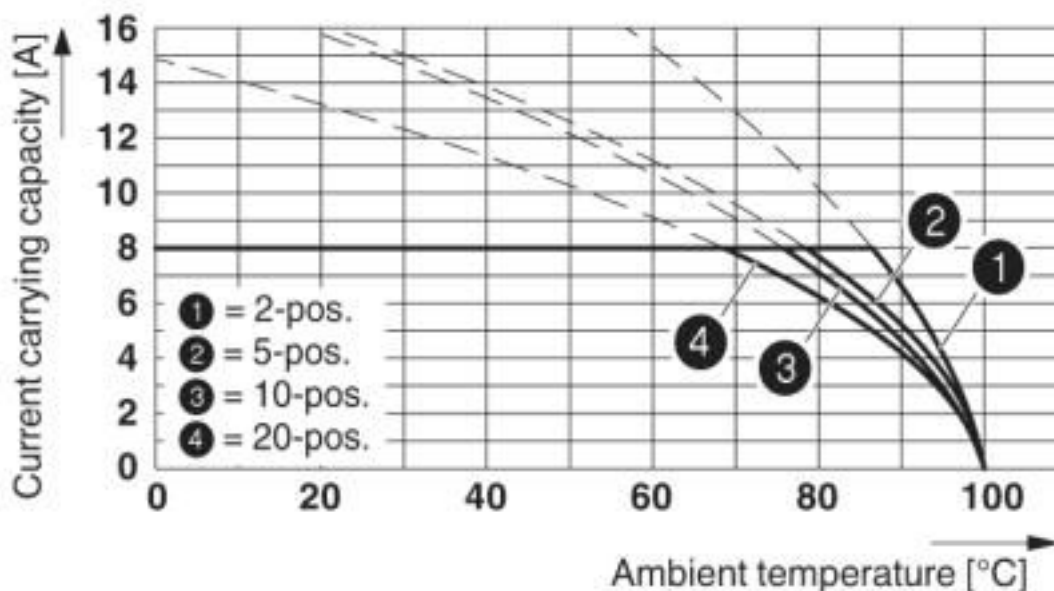

Type: MCC 1/...-ST-3,81 with MC 1,5/...-G-3,81; contact: MCC-MT 0,5 - 1,0

Dimensional drawing

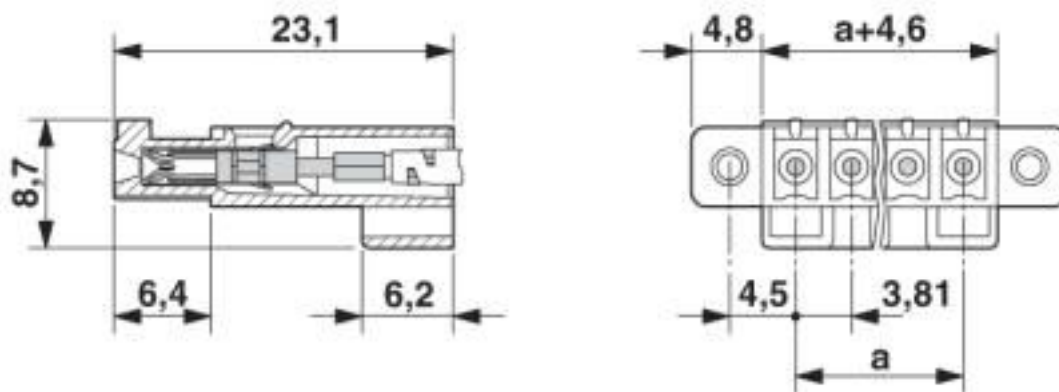

Printed-circuit board connector - MCC 1/15-STZF-3,81 - 1852493

Classifications

eCl@ss

eCl@ss 10.0.1	27440309
eCl@ss 4.0	27260700
eCl@ss 4.1	27260700
eCl@ss 5.0	27260700
eCl@ss 5.1	27260700
eCl@ss 6.0	27260700
eCl@ss 7.0	27440309
eCl@ss 8.0	27440309
eCl@ss 9.0	27440309

ETIM

ETIM 3.0	EC001121
ETIM 4.0	EC002638
ETIM 5.0	EC002638
ETIM 6.0	EC002638
ETIM 7.0	EC002638

UNSPSC

UNSPSC 6.01	30211810
UNSPSC 7.0901	39121409
UNSPSC 11	39121409
UNSPSC 12.01	39121409
UNSPSC 13.2	39121409
UNSPSC 18.0	39121409
UNSPSC 19.0	39121409
UNSPSC 20.0	39121409
UNSPSC 21.0	39121409

Approvals

Approvals

Approvals

EAC / cULus Recognized

Ex Approvals

Approval details

Printed-circuit board connector - MCC 1/15-STZF-3,81 - 1852493

Approvals

EAC		B.01687
-----	--	---------

cULus Recognized		http://database.ul.com/cgi-bin/XYV/template/LISEXT/1FRAME/index.htm	E60425-20110128
	B	D	
Nominal voltage UN	300 V	300 V	
Nominal current IN	5 A	5 A	
mm ² /AWG/kcmil	24-22	24-22	

Accessories

Accessories

Crimp contact

Accessories - MCC-MT 0,2-0,35 - 1859988



Female contact, is inserted into the plug after crimping the conductor, for the module plug housing MCC 1...-STZ-3,81 and MCC 1...-STZF-3,81, for cross sections of 0.2 mm² to 0.34 mm²

Female insert - MCC-MT 0,5-1,0 - 1859991



Female contact, is inserted into the plug after crimping the conductor, for the module plug housing MCC 1...-STZ-3,81 and MCC 1...-STZF-3,81, for cross sections of 0.5 mm² to 1 mm²

Accessories - MCC-MT 0,2-0,35 (0,0) BA - 1923717



Female contact, is inserted into the plug after crimping the conductor, for the module plug housing MCC 1...-STZ-3,81 and MCC 1...-STZF-3,81, for cross sections of 0.2 mm² to 0.34 mm²

Printed-circuit board connector - MCC 1/15-STZF-3,81 - 1852493

Accessories

Female insert - MCC-MT 0,5-1,0 BAND - 1898622



Female contact, is inserted into the plug after crimping the conductor, for the module plug housing MCC 1...-STZ-3,81 and MCC 1...-STZF-3,81, for cross sections of 0.5 mm² to 1 mm²

Labeled terminal marker

Marker card - SK 3,81/2,8:FORTL.ZAHLEN - 0804109



Marker card, Card, white, labeled, horizontal: consecutive numbers 1 ... 10, 11 ... 20, etc. up to 91 ... (99)100, mounting type: adhesive, for terminal block width: 3.81 mm, lettering field size: 3.81 x 2.8 mm

Mounting material

Crimping pliers - CRIMPFOX-1,6-ER-1,50-GH - 1772793



Crimping pliers, for IBS DSUB.../C

Screwdriver tools

Screwdriver - SZS 0,4X2,5 VDE - 1205037



Screwdriver, slot-headed, VDE insulated, size: 0.4 x 2.5 x 80 mm, 2-component grip, with non-slip grip

Strain relief

Strain relief - STZ 2-PCC 4-7,62 - 1840214



Strain relief, for the 3 to 4-position MCC 1/...STZ-3,81 and MCC 1/...STZF-3,81 plugs, for snapping into the latching chambers, can be labeled with ZB 6

Printed-circuit board connector - MCC 1/15-STZF-3,81 - 1852493

Accessories

Strain relief - STZ 3-PCC 4-7,62 - 1840227

Strain relief, for the 5 to 10-position MCC 1/...STZ-3,81 and MCC 1/...STZF-3,81 plugs, for snapping into the latching chambers, can be labeled with ZB 6

Strain relief - STZ 5-PCC 4-7,62 GN - 1842005

Strain relief, for the 11 to 15-position MCC 1/...STZ-3,81 and MCC 1/...STZF-3,81 plugs, for snapping into the latching chambers, can be labeled with ZB 6

Strain relief - STZ 8-PCC 4-7,62 - 1840230

Strain relief, for the 16 to 20-position MCC 1/...STZ-3,81 and MCC 1/...STZF-3,81 plugs, for snapping into the latching chambers, can be labeled with ZB 6

Additional products

Feed-through header - SMC 1,5/15-GF-3,81 - 1827554

PCB headers, nominal current: 8 A, rated voltage (III/2): 160 V, nominal cross section: 1.5 mm², number of positions: 15, pitch: 3.81 mm, color: green, contact surface: Tin, mounting: Wave soldering, pin layout: Linear pinning, solder pin [P]: 3.4 mm



Printed-circuit board connector - MC 1,5/15-GF-3,81 - 1827994

PCB headers, nominal current: 8 A, rated voltage (III/2): 160 V, nominal cross section: 1.5 mm², number of positions: 15, pitch: 3.81 mm, color: green, contact surface: Tin, mounting: Wave soldering, pin layout: Linear pinning, solder pin [P]: 3.4 mm



Feed-through header - MCD 1,5/15-GF-3,81 - 1830237

PCB headers, nominal current: 8 A, rated voltage (III/2): 160 V, nominal cross section: 1.5 mm², number of positions: 15, pitch: 3.81 mm, color: green, contact surface: Tin, mounting: Wave soldering, pin layout: Linear pinning, solder pin [P]: 3.5 mm, In combination with MCV plug components, both an MCVW and an MCVR plug must be used.



Printed-circuit board connector - MCC 1/15-STZF-3,81 - 1852493

Accessories

Feed-through header - MCDV 1,5/15-GF-3,81 - 1830389



PCB headers, nominal current: 8 A, rated voltage (III/2): 160 V, nominal cross section: 1.5 mm², number of positions: 15, pitch: 3.81 mm, color: green, contact surface: Tin, mounting: Wave soldering, pin layout: Linear pinning, solder pin [P]: 3.4 mm, In combination with MCV plug components, both an MCVW and an MCVR plug must be used.

Feed-through header - MCV 1,5/15-GF-3,81 - 1830729



PCB headers, nominal current: 8 A, rated voltage (III/2): 160 V, nominal cross section: 1.5 mm², number of positions: 15, pitch: 3.81 mm, color: green, contact surface: Tin, mounting: Wave soldering, pin layout: Linear pinning, solder pin [P]: 3.4 mm

Feed-through header - MCDV 1,5/15-G1F-3,81 - 1842898



PCB headers, nominal current: 8 A, rated voltage (III/2): 160 V, nominal cross section: 1.5 mm², number of positions: 15, pitch: 3.81 mm, color: green, contact surface: Tin, mounting: Wave soldering, pin layout: Linear pinning, solder pin [P]: 3.4 mm, In combination with MCV plug components, both an MCVW and an MCVR plug must be used.

Printed-circuit board connector - MCD 1,5/15-G1F-3,81 - 1843059



PCB headers, nominal current: 8 A, rated voltage (III/2): 160 V, nominal cross section: 1.5 mm², number of positions: 15, pitch: 3.81 mm, color: green, contact surface: Tin, mounting: Wave soldering, pin layout: Linear pinning, solder pin [P]: 3.5 mm, In combination with MCV plug components, both an MCVW and an MCVR plug must be used.

Feed-through header - EMCV 1,5/15-GF-3,81 - 1879418



PCB headers, nominal current: 8 A, rated voltage (III/2): 160 V, nominal cross section: 1.5 mm², number of positions: 15, pitch: 3.81 mm, color: green, contact surface: Tin, mounting: Press-in technology, pin layout: Linear pinning, solder pin [P]: 3.8 mm

Printed-circuit board connector - MCC 1/15-STZF-3,81 - 1852493

Accessories

Feed-through header - EMC 1,5/15-GF-3,81 - 1897076

PCB headers, nominal current: 8 A, rated voltage (III/2): 160 V, nominal cross section: 1.5 mm², number of positions: 15, pitch: 3.81 mm, color: green, contact surface: Tin, mounting: Press-in technology, pin layout: Linear pinning, solder pin [P]: 3.5 mm



Phoenix Contact 2020 © - all rights reserved
<http://www.phoenixcontact.com>

PHOENIX CONTACT GmbH & Co. KG
Flachsmarktstr. 8
32825 Blomberg
Germany
Tel. +49 5235 300
Fax +49 5235 3 41200
<http://www.phoenixcontact.com>

X-ON Electronics

Largest Supplier of Electrical and Electronic Components

Click to view similar products for [Pluggable Terminal Blocks](#) category:

Click to view products by [Phoenix Contact](#) manufacturer:

Other Similar products are found below :

[57.510.0053](#) [MC 1.5/ 6-ST-3.5 GY AU](#) [734-104](#) [734-302](#) [8-141-P](#) [8426620000](#) [860505](#) [860810](#) [GBPACX-12](#) [93.731.4953.0](#) [PV05-5,08-K](#)
[PVP02-5,00](#) [PVP03-3,50](#) [PVP04-3,50](#) [PVS02-5,00](#) [1-1986160-3](#) [1377680000](#) [1531000000](#) [1546228-5](#) [ELFH16150](#) [ELFP03110](#)
[ELFP10210](#) [ELFT06250](#) [ELVP03100](#) [1700101](#) [1700410](#) [1700425](#) [1702246](#) [1705229](#) [1710175](#) [1714537](#) [1717806](#) [1719600](#) [1728941](#)
[1734692](#) [1734795](#) [1736036](#) [1740194](#) [1740291](#) [1740628](#) [1740990](#) [1746952](#) [1750207](#) [1752441](#) [1752865](#) [1754115](#) [1754144](#) [1756913](#)
[1760051](#) [1760336](#)