

Header - DFK-PC 4/ 4-G-7,62-FS4,8 - 1861170

Please be informed that the data shown in this PDF Document is generated from our Online Catalog. Please find the complete data in the user's documentation. Our General Terms of Use for Downloads are valid (<http://phoenixcontact.com/download>)



Feed-through header, nominal current: 15 A, rated voltage (III/2): 400 V, nominal cross section: 4 mm², number of positions: 4, pitch: 7.62 mm, connection method: Slip-on connection, color: green, contact surface: Tin, mounting: Direct mounting

The figure shows a 5-pos. version of the product

Your advantages

- Space-saving, standardized slip-on connection allows worldwide use
- Cable connection on the inside of the device enables flexible positioning of the panel feed-through



Key Commercial Data

Packing unit	50 pc
GTIN	
GTIN	4017918125691

Technical data

Item properties

Brief article description	Feed-through header
Plug-in system	POWER COMBICON 4
Type of contact	Male connector
Range of articles	DFK-PC 4/..-G -FS4,8
Pitch	7.62 mm
Number of positions	4
Connection method	Slip-on connection
Mounting type	Direct mounting
Locking	without
Number of levels	1
Number of connections	4
Number of potentials	4

Header - DFK-PC 4/ 4-G-7,62-FS4,8 - 1861170

Technical data

Electrical parameters

Nominal current	15 A
Nom. voltage	400 V
Max. current slip-on connection	15 A
Rated voltage	400 V
Rated voltage (III/2)	400 V
Rated voltage (II/2)	800 V
Rated surge voltage (III/3)	6 kV
Rated surge voltage (III/2)	6 kV
Rated surge voltage (II/2)	6 kV

Connection capacity

Connection method	Slip-on connection
pluggable	Yes
Conductor cross section solid	0.2 mm ² ... 4 mm ²
Conductor cross section flexible	0.2 mm ² ... 4 mm ²
Conductor cross section AWG / kcmil	24 ... 10

Material data - contact

Note	WEEE/RoHS-compliant, free of whiskers according to IEC 60068-2-82/ JEDEC JESD 201
Contact material	Cu alloy
Surface characteristics	Tin-plated
Metal surface contact area (top layer)	Tin (5 - 10 µm Sn)
Metal surface contact area (middle layer)	Nickel (2 - 5 µm Ni),
Metal surface soldering area (top layer)	Tin (5 - 7 µm Sn)
Metal surface soldering area (middle layer)	Nickel (2 - 3 µm Ni)

Material data - housing

Housing color	green (6021)
Insulating material	PA
Insulating material group	I
CTI according to IEC 60112	600
Flammability rating according to UL 94	V2

Dimensions for the product

Length [l]	37.35 mm
Width [w]	45.7 mm
Height [h]	14.3 mm
Pitch	7.62 mm
Height (without solder pin)	14.3 mm
Dimensions of slip-on connection	4,8 x 0,8 mm

Packaging information

Type of packaging	packed in cardboard
-------------------	---------------------

Header - DFK-PC 4/ 4-G-7,62-FS4,8 - 1861170

Technical data

Packaging information

Pieces per package	50
Denomination packing units	Pcs.

Mechanical tests according to standard

Test specification	IEC 61984
--------------------	-----------

Mechanical tests (A)

Test specification	IEC 61984
--------------------	-----------

Standards and Regulations

Connection in acc. with standard	EN-VDE
	CSA
Flammability rating according to UL 94	V2

Environmental Product Compliance

China RoHS	Environmentally friendly use period: unlimited = EFUP-e
	No hazardous substances above threshold values

Drawings

Diagram

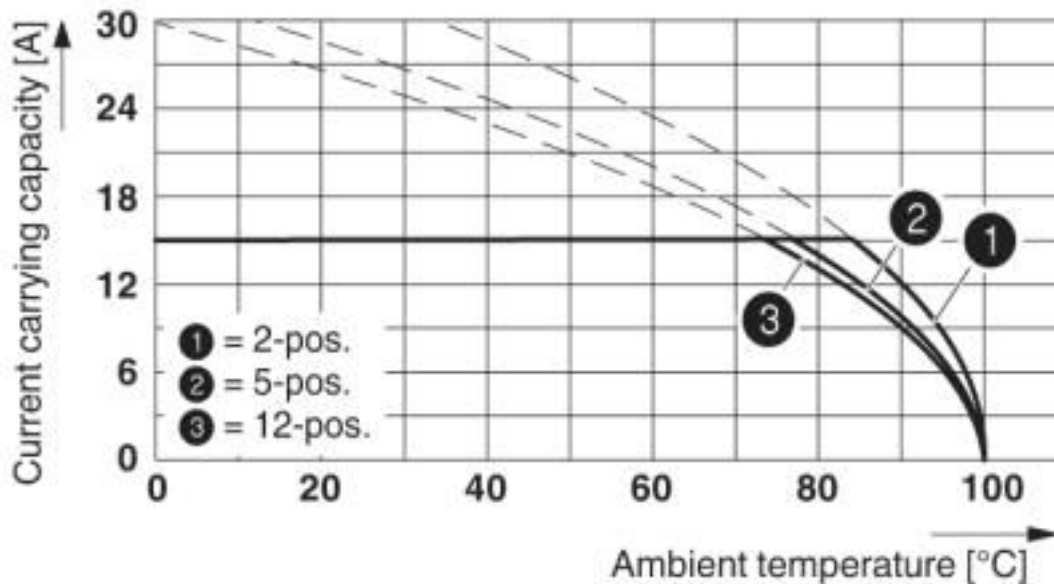

Derating curve for: PC 4/...-ST-7,62 with DFK-PC 4/...-G-7,62-FS4,8

Header - DFK-PC 4/ 4-G-7,62-FS4,8 - 1861170

Dimensional drawing

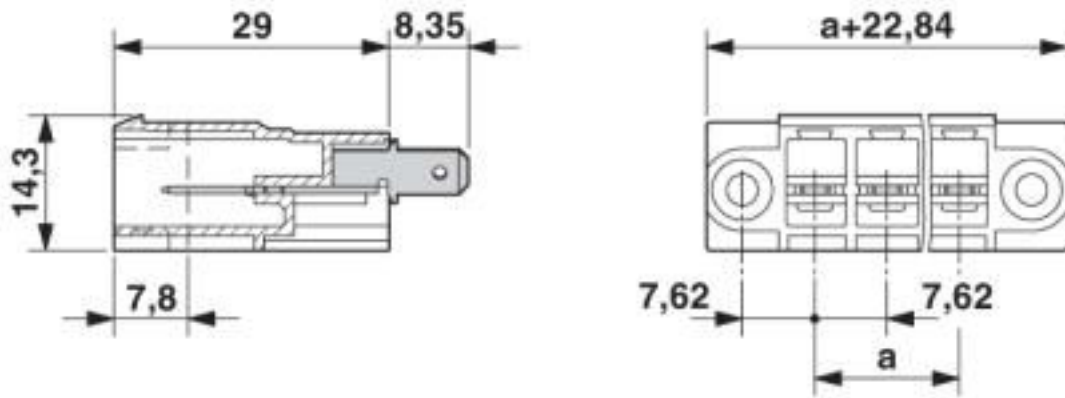

Dimensional drawing

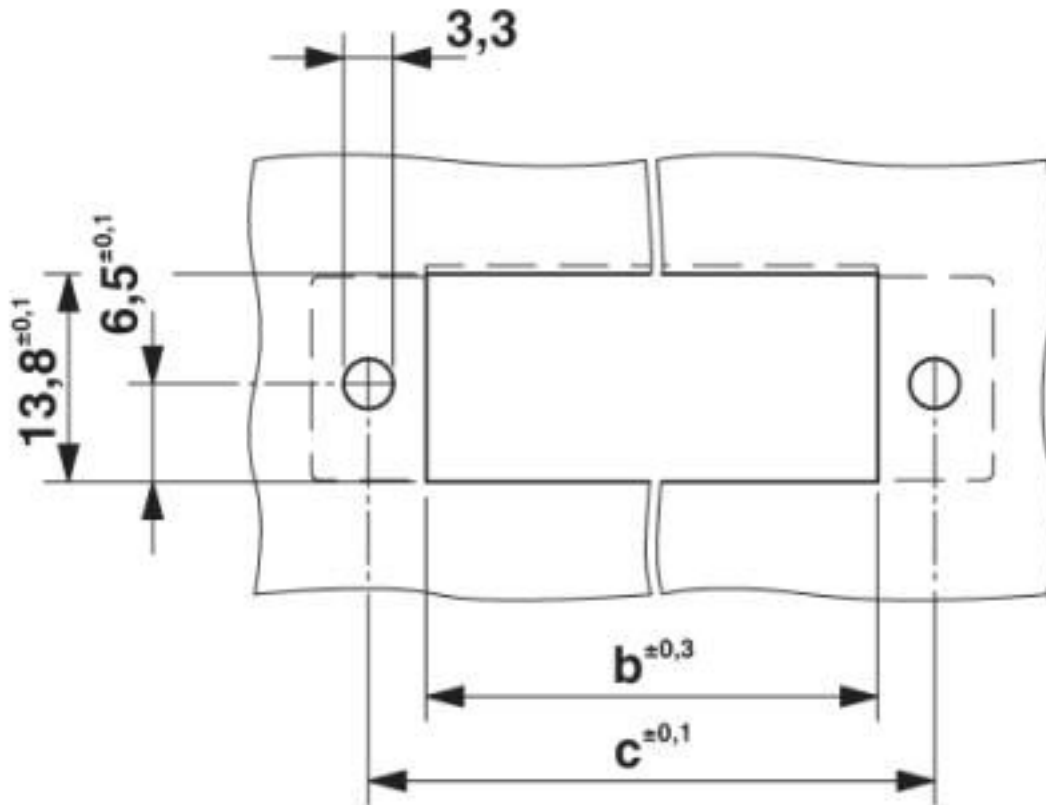

Dimension b = 30.43 mm; dimension c = 38.10 mm

Classifications

eCl@ss

eCl@ss 10.0.1	27440402
eCl@ss 4.0	27260700

Header - DFK-PC 4/ 4-G-7,62-FS4,8 - 1861170

Classifications

eCl@ss

eCl@ss 4.1	27260700
eCl@ss 5.0	27141100
eCl@ss 5.1	27141100
eCl@ss 6.0	27141100
eCl@ss 7.0	27141134
eCl@ss 8.0	27440402
eCl@ss 9.0	27440402

ETIM

ETIM 3.0	EC001283
ETIM 4.0	EC002638
ETIM 5.0	EC002637
ETIM 6.0	EC002637
ETIM 7.0	EC002637

UNSPSC

UNSPSC 6.01	30211810
UNSPSC 7.0901	39121409
UNSPSC 11	39121409
UNSPSC 12.01	39121409
UNSPSC 13.2	39121410
UNSPSC 18.0	39121409
UNSPSC 19.0	39121409
UNSPSC 20.0	39121409
UNSPSC 21.0	39121409

Approvals

Approvals

Approvals

CSA / EAC / cULus Recognized

Ex Approvals

Approval details

Header - DFK-PC 4/ 4-G-7,62-FS4,8 - 1861170

Approvals

CSA		http://www.csagroup.org/services-industries/product-listing/	13631
		B	C
Nominal voltage UN		300 V	300 V
Nominal current IN		20 A	20 A

EAC			B.01687
-----	--	--	---------

cULus Recognized		http://database.ul.com/cgi-bin/XYV/template/LISEXT/1FRAME/index.htm	E60425-19920722
		B	C
Nominal voltage UN		300 V	300 V
Nominal current IN		20 A	20 A

Accessories

Accessories

Coding element

Coding profile - CP-PC RD - 1701967



Coding profile, for plugging into the coding ribs of the plug at a later date, insulating material, color: Red

Labeled terminal marker

Marker card - SK 7,62/3,8:FORTL.ZAHLEN - 0804549



Marker card, Card, white, labeled, horizontal: consecutive numbers 1 ... 10, 11 ... 20, etc. up to 91 ... 100, mounting type: adhesive, for terminal block width: 7.62 mm, lettering field size: 7.62 x 3.8 mm

Header - DFK-PC 4/ 4-G-7,62-FS4,8 - 1861170

Accessories

Marker card - SK 3,8 REEL P7,62 WH CUS - 0825128



Marker card, Card, can be ordered: by card, white, labeled according to customer specifications, mounting type: adhesive, for terminal block width: 7.62 mm, lettering field size: continuous x 3.8#mm

Mounting material

Screw set - DFK-MSTB-SS - 0708263



Screw set, for securing the header to the device wall, consists of an M3 x 10 screw, with a spring washer and a nut

Screwdriver tools

Screwdriver - SZS 0,6X3,5 - 1205053



Actuation tool, for ST terminal blocks, insulated, also suitable for use as a bladed screwdriver, size: 0.6 x 3.5 x 100 mm, 2-component grip, with non-slip grip

Terminal marking

Marker card - SK U/3,8 WH:UNBEDRUCKT - 0803906



Marker card, Sheet, white, unlabeled, can be labeled with: PLOTMARK, CMS-P1-PLOTTER, Office printing systems, mounting type: adhesive, for terminal block width: 210 mm, lettering field size: 186 x 3.8 mm, Number of individual labels: 1440

Marker strip - SK 3,8 WH:REEL - 0805218



Marker strip, Roll, white, unlabeled, can be labeled with: THERMOMARK ROLL 2.0, THERMOMARK ROLL, THERMOMARK ROLL X1, THERMOMARK ROLLMASTER 300/600, THERMOMARK X1.2, mounting type: adhesive, for terminal block width: 90000 mm, lettering field size: continuous x 3.8#mm, Number of individual labels: 210000

Additional products

Header - DFK-PC 4/ 4-G-7,62-FS4,8 - 1861170

Accessories

Printed-circuit board connector - PC 4/ 4-ST-7,62 - 1804920



PCB connector, nominal current: 20 A, rated voltage (III/2): 630 V, nominal cross section: 4 mm², number of positions: 4, pitch: 7.62 mm, connection method: Screw connection with tension sleeve, color: green, contact surface: Tin

Printed-circuit board connector - PCC 4/ 4-ST-7,62 - 1840175



PCB connector, nominal current: 20 A, rated voltage (III/2): 1000 V, nominal cross section: 4 mm², number of positions: 4, pitch: 7.62 mm, connection method: Crimp connection, color: green, Corresponding female crimp contacts with current [A] and conductor cross section range [mm²] data: 13,5A/STG-MTN 0,5-1,0 (3190438); 13,5A/STG-MTN 0,5-1,0 BA (3190629); 20A/STG-MTN 1,5-2,5 (3190506); 20A/STG-MTN 1,5-2,5 BA (3190632). BA = Taped contacts

Printed-circuit board connector - PC 5/ 4-ST1-7,62 - 1777749



PCB connector, nominal current: 41 A, rated voltage (III/2): 1000 V, nominal cross section: 6 mm², number of positions: 4, pitch: 7.62 mm, connection method: Screw connection with tension sleeve, color: green, contact surface: Tin

Printed-circuit board connector - SPC 5/ 4-ST-7,62 - 1996032



PCB connector, nominal current: 41 A, rated voltage (III/2): 1000 V, nominal cross section: 6 mm², number of positions: 4, pitch: 7.62 mm, connection method: Push-in spring connection, color: green, contact surface: Tin

Printed-circuit board connector - TSPC 5/ 4-ST-7,62 - 1728471



PCB connector, nominal current: 41 A, rated voltage (III/2): 1000 V, nominal cross section: 6 mm², number of positions: 4, pitch: 7.62 mm, connection method: Push-in spring connection, color: green, contact surface: Tin

Phoenix Contact 2020 © - all rights reserved
<http://www.phoenixcontact.com>

PHOENIX CONTACT GmbH & Co. KG
Flachmarktstr. 8
32825 Blomberg
Germany
Tel. +49 5235 300
Fax +49 5235 3 41200
<http://www.phoenixcontact.com>

X-ON Electronics

Largest Supplier of Electrical and Electronic Components

Click to view similar products for [Pluggable Terminal Blocks](#) category:

Click to view products by [Phoenix Contact](#) manufacturer:

Other Similar products are found below :

[57.510.0053](#) [MC 1.5/ 6-ST-3.5 GY AU](#) [734-104](#) [734-302](#) [8-141-P](#) [8426620000](#) [860505](#) [860810](#) [GBPACX-12](#) [93.731.4953.0](#) [PV05-5,08-K](#)
[PVP02-5,00](#) [PVP03-3,50](#) [PVP04-3,50](#) [PVS02-5,00](#) [1-1986160-3](#) [1377680000](#) [1531000000](#) [1546228-5](#) [ELFH16150](#) [ELFP03110](#)
[ELFP10210](#) [ELFT06250](#) [ELVP03100](#) [1700101](#) [1700410](#) [1700425](#) [1702246](#) [1705229](#) [1710175](#) [1714537](#) [1717806](#) [1719600](#) [1728941](#)
[1734692](#) [1734795](#) [1736036](#) [1740194](#) [1740291](#) [1740628](#) [1740990](#) [1746952](#) [1750207](#) [1752441](#) [1752865](#) [1754115](#) [1754144](#) [1756913](#)
[1760051](#) [1760336](#)