

PCB terminal block - SPTAF 1/ 7-3,5-IL - 1861988

Please be informed that the data shown in this PDF Document is generated from our Online Catalog. Please find the complete data in the user's documentation. Our General Terms of Use for Downloads are valid (<http://phoenixcontact.com/download>)

PCB terminal block, nominal current: 16 A, rated voltage (III/2): 160 V, nominal cross section: 1.5 mm², pitch: 3.5 mm, number of positions: 7, connection method: Push-in spring connection, mounting: Wave soldering, conductor/PCB connection direction: 45 °, color: green, Pin layout: Linear double pinning, Solder pin [P]: 2.6 mm



The figure shows a 10-position version of the product

Your advantages

- Time saving push-in connection, tools not required
- Defined contact force ensures that contact remains stable over the long term
- Intuitive use through colour coded actuation lever
- Small component size for applications where space is at a premium
- Quick and convenient testing using integrated test option



Key Commercial Data

Packing unit	70 pc
Minimum order quantity	70 pc
GTIN	 4 055626 135021
GTIN	4055626135021

Technical data

Item properties

Brief article description	PCB terminal block
Range of articles	SPTAF 1/...-IL
Pitch	3.5 mm
Number of positions	7
Connection method	Push-in spring connection
Mounting type	Wave soldering
Pin layout	Linear double pinning
Number of levels	1
Number of connections	7

PCB terminal block - SPTAF 1/ 7-3,5-IL - 1861988

Technical data

Item properties

Number of potentials	7
----------------------	---

Electrical parameters

Nominal current	16 A
Nom. voltage	160 V
Rated voltage	160 V
Rated voltage (III/2)	160 V
Rated voltage (II/2)	320 V
Rated surge voltage (III/3)	2.5 kV
Rated surge voltage (III/2)	2.5 kV
Rated surge voltage (II/2)	2.5 kV

Connection capacity

Connection method	Push-in spring connection
Conductor cross section solid	0.2 mm ² ... 1.5 mm ² (When connecting and possibly adjusting a solid conductor of 1.5 mm ² , the mechanical lateral forces, which can affect the terminal block, have to be absorbed by lateral support.)
Conductor cross section flexible	0.2 mm ² ... 1.5 mm ²
Conductor cross section AWG / kcmil	24 ... 16
Conductor cross section flexible, with ferrule without plastic sleeve	0.25 mm ² ... 0.75 mm ²
Conductor cross section, flexible, with ferrule, with plastic sleeve	0.25 mm ² ... 0.75 mm ²
Stripping length	8 mm

Material data - contact

Note	WEEE/RoHS-compliant, free of whiskers according to IEC 60068-2-82/ JEDEC JESD 201
Contact material	Cu alloy
Surface characteristics	hot-dip tin-plated
Metal surface terminal point (top layer)	Tin (2 - 4 µm Sn)
Metal surface soldering area (top layer)	Tin (2 - 4 µm Sn)

Material data - housing

Housing color	green (6021)
Insulating material	PA
Insulating material group	I
CTI according to IEC 60112	600
Flammability rating according to UL 94	V0

Dimensions for the product

Length [l]	11 mm
Width [w]	26 mm
Height [h]	10.6 mm
Pitch	3.5 mm
Height (without solder pin)	8 mm

PCB terminal block - SPTAF 1/ 7-3,5-IL - 1861988

Technical data

Dimensions for the product

Solder pin [P]	2.6 mm
Pin spacing	5 mm
Pin dimensions	0.75 x 0.3 mm

Dimensions for PCB design

Hole diameter	1.1 mm
Pin spacing	5 mm

Packaging information

Type of packaging	packed in cardboard
Pieces per package	70
Denomination packing units	Pcs.

General product information

Type of note	Note on application
Note	Maximum permissible outer diameter of the wire insulation ≤ 3 mm

Processing notes

Process	Wave soldering
Specification	Following IEC 61760-1:2006-04
	Following IEC 60068-2-54:2006-04

Ambient conditions

Ambient temperature (storage/transport)	-40 °C ... 70 °C
Ambient temperature (assembly)	-5 °C ... 100 °C
Ambient temperature (operation)	-40 °C ... 100 °C (dependent on the derating curve)

Termination and connection method

Test – repeated connection and release	IEC 60999-1:1999-11
	Test passed
Test for conductor damage and slackening	IEC 60999-1:1999-11
	Test passed

Pull-out test

Pull-out test	IEC 60999-1:1999-11
	Test passed
Conductor cross section / conductor type / tensile force	0.2 mm ² / solid / > 10 N
	0.25 mm ² / flexible / > 10 N
	1.5 mm ² / solid / > 40 N
	1.5 mm ² / flexible / > 40 N

Mechanical tests according to standard

Test specification	IEC 60947-7-4
--------------------	---------------

Electrical tests

Rated current	16 A
---------------	------

PCB terminal block - SPTAF 1/ 7-3,5-IL - 1861988

Technical data

Electrical tests

Conductor cross section	1.5 mm ²
Rated voltage (III/2)	160 V
Rated surge voltage (III/2)	2.5 kV

Air clearances and creepage distances

Clearances and creepage distances	IEC 60947-1:2007-06 + A1:2010-12
Specification	IEC 60947-1:2007-06 + A1:2010-12
Minimum clearance - inhomogeneous field (III/3)	1.5 mm
Minimum clearance - inhomogeneous field (III/2)	1.5 mm
Minimum clearance - inhomogeneous field (II/2)	1.5 mm
Minimum creepage distance value (III/3)	2 mm
Minimum creepage distance value (III/2)	0.8 mm
Minimum creepage distance value (II/2)	1.6 mm

Temperature-rise test

Specification	IEC 60947-7-4:2013-08
Result	Test passed
Requirement temperature-rise test	The sum of ambient temperature and temperature rise of the PCB terminal block shall not exceed the upper limiting temperature.

Current carrying capacity / derating curves

Caption	Type: SPTAF 1/...-3,5-IL(EL)
Specification	IEC 60947-7-4:2013-08
Number of positions	4
Reduction factor	1
Note	Representation based on IEC 60512-5-2:2002-02

Vibration test

Specification	IEC 60068-2-6:2007-12
Result	Test passed
Frequency	10 - 150 - 10 Hz
Sweep speed	1 octave/min
Amplitude	0.35 mm (10 - 60.1 Hz)
Acceleration	5 g (60.1 - 150 Hz)
Test duration per axis	2.5 h

Insulation resistance

Specification	IEC 60512-3-1:2002-02
Result	Test passed
Insulation resistance, neighboring positions	> 0,4 TΩ

Glow-wire test

Specification	IEC 60695-2-10:2013-04
Result	Test passed

PCB terminal block - SPTAF 1/ 7-3,5-IL - 1861988

Technical data

Glow-wire test

Temperature	850 °C
Time of exposure	5 s

Alternating climate test

Result	Test passed
Specification	ISO 6988:1985-02
Corrosive stress	KFW 0.2 S/1 cycle

Standards and Regulations

Connection in acc. with standard	EN-VDE
Flammability rating according to UL 94	V0

Environmental Product Compliance

China RoHS	Environmentally friendly use period: unlimited = EFUP-e
	No hazardous substances above threshold values

Drawings

PCB terminal block - SPTAF 1/ 7-3,5-IL - 1861988

Drilling diagram

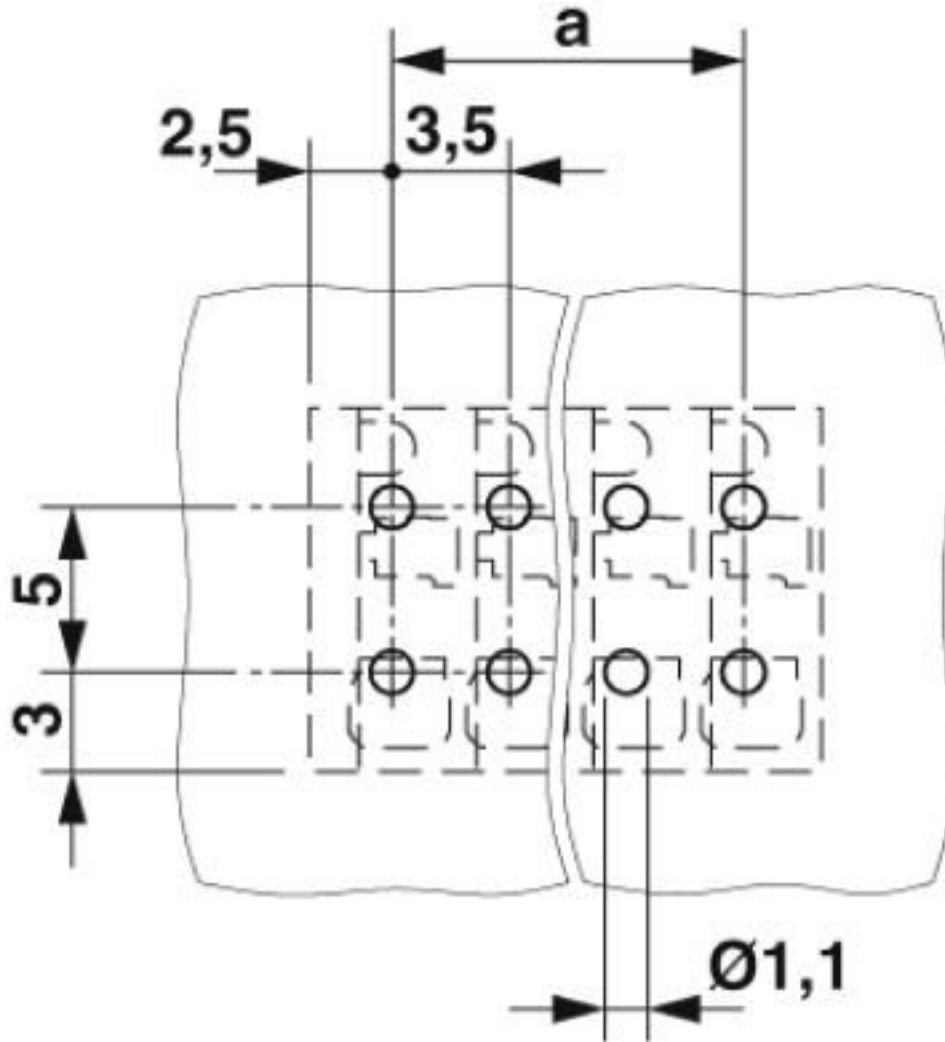

PCB terminal block - SPTAF 1/ 7-3,5-IL - 1861988

Diagram

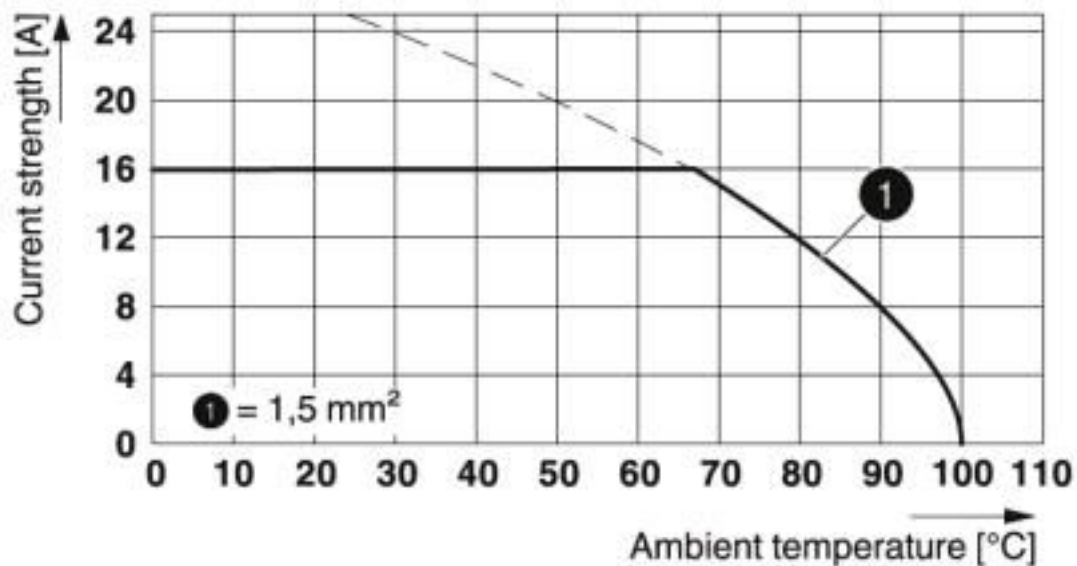

Type: SPTAF 1/...-3,5-IL(EL)

Dimensional drawing

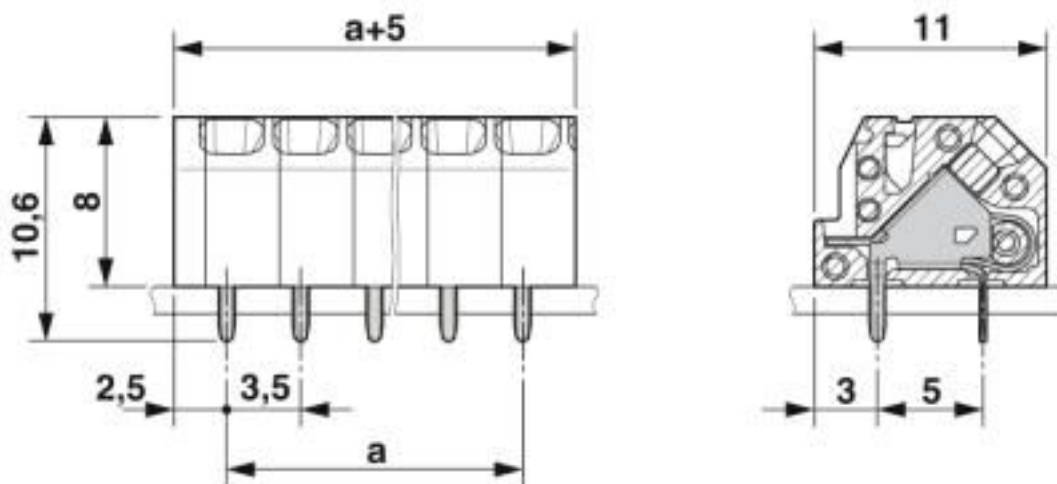

Classifications

eCl@ss

eCl@ss 10.0.1	27440401
eCl@ss 5.1	27261100
eCl@ss 6.0	27261100
eCl@ss 7.0	27440401
eCl@ss 8.0	27440401
eCl@ss 9.0	27440401

PCB terminal block - SPTAF 1/ 7-3,5-IL - 1861988

Classifications

ETIM

ETIM 5.0	EC002643
ETIM 6.0	EC002643
ETIM 7.0	EC002643

UNSPSC

UNSPSC 13.2	39121432
UNSPSC 18.0	39121432
UNSPSC 19.0	39121432
UNSPSC 20.0	39121432
UNSPSC 21.0	39121432

Approvals

Approvals

Approvals

IECEE CB Scheme / VDE Zeichengenehmigung / cULus Recognized / EAC

Ex Approvals

Approval details

IECEE CB Scheme		http://www.iecee.org/	DE1-61914
Nominal voltage UN	160 V		
Nominal current IN	16 A		
mm ² /AWG/kcmil	0.2-1.5		

VDE Zeichengenehmigung		http://www2.vde.com/de/Institut/Online-Service/VDE-gepruefteProdukte/Seiten/Online-Suche.aspx	40047107
Nominal voltage UN	160 V		
Nominal current IN	16 A		
mm ² /AWG/kcmil	0.2-1.5		

PCB terminal block - SPTAF 1/ 7-3,5-IL - 1861988

Approvals

cULus Recognized		http://database.ul.com/cgi-bin/XYV/template/LISEXT/1FRAME/index.htm	E60425-20061129
	B	D	
Nominal voltage UN	300 V	300 V	
Nominal current IN	8 A	8 A	
mm²/AWG/kcmil	24-16	24-16	

EAC		B.01687
-----	--	---------

Accessories

Accessories

Crimping tool

Crimping pliers - CRIMPFOX 6 - 1212034



Crimping pliers, for ferrules without insulating collar according to DIN 46228 Part 1 and ferrules with insulating collar according to DIN 46228 Part 4, 0.25 mm² ... 6.0 mm², lateral entry, trapezoidal crimp

Screwdriver tools

Screwdriver - SZF 0-0,4X2,5 - 1204504



Actuation tool, for ST terminal blocks, also suitable for use as a bladed screwdriver, size: 0.4 x 2.5 x 75 mm, 2-component grip, with non-slip grip

X-ON Electronics

Largest Supplier of Electrical and Electronic Components

Click to view similar products for [Fixed Terminal Blocks](#) category:

Click to view products by [Phoenix Contact](#) manufacturer:

Other Similar products are found below :

[MBE-1512](#) [MBE-154](#) [MBE-156](#) [MBES-153](#) [MBES-156](#) [MH-2512](#) [MHE-132](#) [MHE-163](#) [MI-254 \(35\)](#) [MI-272](#) [880507](#) [MPT-275](#)
[15602-04-08-21](#) [BA311TU](#) [BA411SU](#) [MV-152](#) [MV-252-D](#) [MV-253/NCNOC](#) [MV-254-D](#) [MV-255](#) [MV-462](#) [MV-493](#) [MVE-252](#) [MVE-253](#)
[MVE-273](#) [MVEB-153](#) [1700096](#) [1705142](#) [1712417](#) [1713020](#) [1713088](#) [1745195](#) [1760594](#) [1776118-2](#) [1790852](#) [1-796689-8](#) [1-796692-6](#)
[1800001](#) [1800114](#) [1995279](#) [20020314-C121B01LF](#) [CB2-12](#) [KP03215000J0G](#) [KP04215000J0G](#) [S451](#) [282802-2](#) [29.007](#) [29.116](#) [30.103](#)
[30.106](#)