

# Printed-circuit board connector - ZEC 1,5/ 8-ST-5,0 C2 R1,8 - 1883103

Please be informed that the data shown in this PDF Document is generated from our Online Catalog. Please find the complete data in the user's documentation. Our General Terms of Use for Downloads are valid (<http://phoenixcontact.com/download>)

PCB direct plug, nominal current: 10 A, rated voltage (III/2): 320 V, nominal cross section: 1.5 mm<sup>2</sup>, number of positions: 8, pitch: 5 mm, connection method: Spring-cage connection, color: green, contact surface: Tin, mounting: Direct plug-in method



The figure shows a 10-position version of the product

## Your advantages

- Defined contact force ensures that contact remains stable over the long term
- Inexpensive direct plug-in connection with just one component
- Clamping space opened by means of fixed screwdriver enables convenient conductor connection
- Plug-in direction parallel to the PCB



## Key Commercial Data

Packing unit	50 pc
GTIN	 4 017918 161064
GTIN	4017918161064

## Technical data

### Dimensions

Length [ l ]	24.05 mm
Width [ w ]	41.4 mm
Height [ h ]	17.5 mm
Pitch	5 mm
Dimension a	35 mm

### General

Range of articles	ZEC 1,5/..-ST
Number of positions	8
Connection method	Spring-cage connection
Insulating material group	I
Rated surge voltage (III/3)	4 kV

# Printed-circuit board connector - ZEC 1,5/ 8-ST-5,0 C2 R1,8 - 1883103

## Technical data

### General

Rated surge voltage (III/2)	4 kV
Rated surge voltage (II/2)	4 kV
Rated voltage (III/3)	250 V
Rated voltage (III/2)	320 V
Rated voltage (II/2)	630 V
Connection in acc. with standard	EN-VDE
Nominal current $I_N$	10 A
Nominal cross section	1.5 mm <sup>2</sup>
Maximum load current	10 A (with 1.5 mm <sup>2</sup> conductor cross section)
Insulating material	PA
Flammability rating according to UL 94	V0
Internal cylindrical gage	A1
Stripping length	7 mm

### Connection data

Conductor cross section solid min.	0.2 mm <sup>2</sup>
Conductor cross section solid max.	1.5 mm <sup>2</sup>
Conductor cross section flexible min.	0.2 mm <sup>2</sup>
Conductor cross section flexible max.	1.5 mm <sup>2</sup>
Conductor cross section flexible, with ferrule without plastic sleeve min.	0.25 mm <sup>2</sup>
Conductor cross section flexible, with ferrule without plastic sleeve max.	1.5 mm <sup>2</sup>
Conductor cross section flexible, with ferrule with plastic sleeve min.	0.25 mm <sup>2</sup>
Conductor cross section flexible, with ferrule with plastic sleeve max.	1.5 mm <sup>2</sup>
Conductor cross section AWG min.	24
Conductor cross section AWG max.	16
Two conductors with the same cross section, flexible, with TWIN ferrules, with plastic sleeve, minimum	0.5 mm <sup>2</sup>
Two conductors with the same cross section, flexible, with TWIN ferrules, with plastic sleeve, maximum	0.5 mm <sup>2</sup>
Minimum AWG according to UL/CUL	26
Maximum AWG according to UL/CUL	14

### Standards and Regulations

Connection in acc. with standard	EN-VDE
	CUL
Flammability rating according to UL 94	V0

### Environmental Product Compliance

China RoHS	Environmentally friendly use period: unlimited = EFUP-e
	No hazardous substances above threshold values

## Drawings

# Printed-circuit board connector - ZEC 1,5/ 8-ST-5,0 C2 R1,8 - 1883103

Drilling diagram

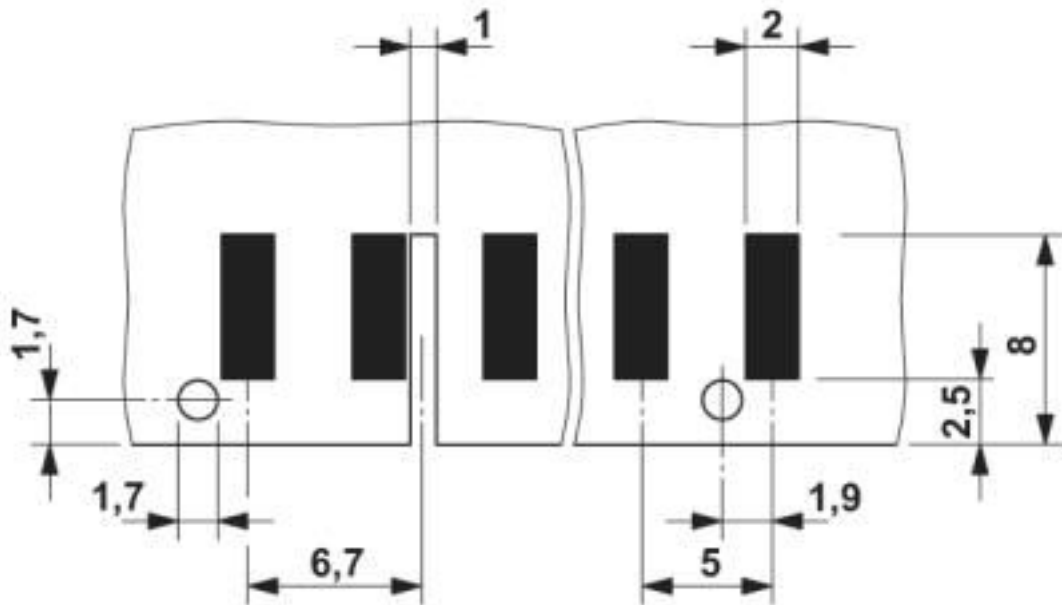

Size of the PCB: 1.6 ± 0.2 mm

Diagram

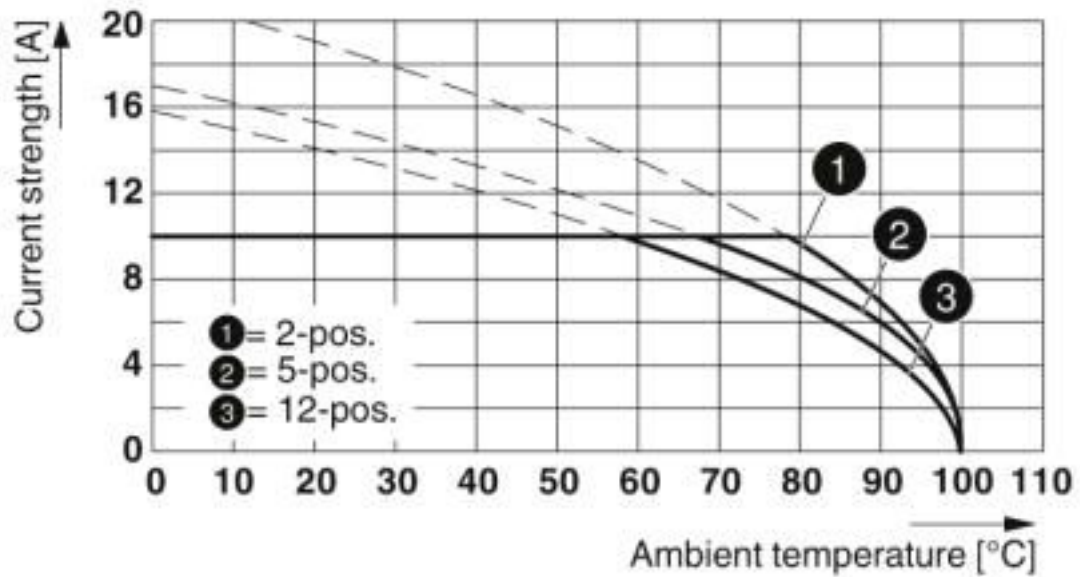

Type: ZEC 1,5/...-ST-5,0

# Printed-circuit board connector - ZEC 1,5/ 8-ST-5,0 C2 R1,8 - 1883103

Dimensional drawing

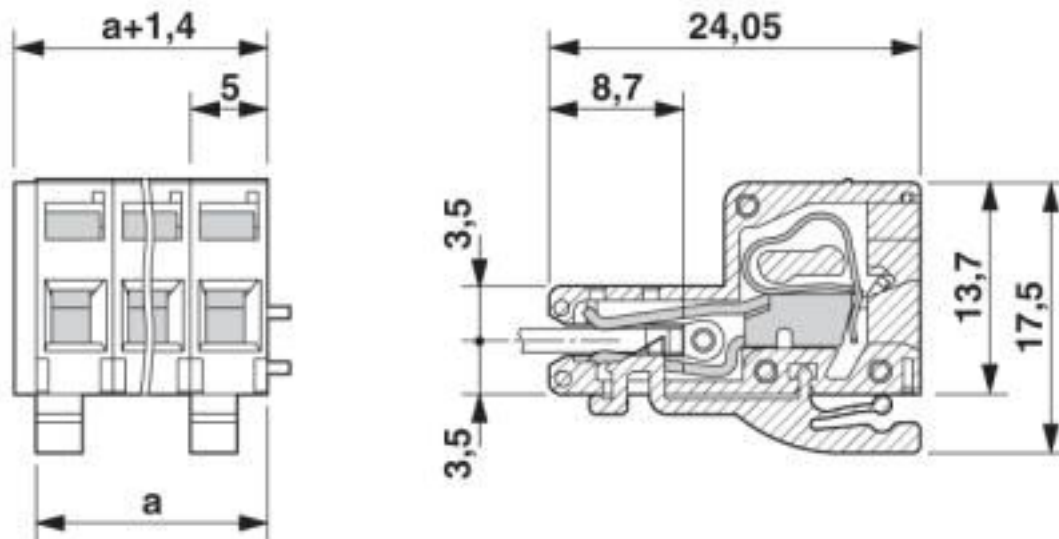

## Classifications

eCl@ss

eCl@ss 10.0.1	27440309
eCl@ss 4.0	27260700
eCl@ss 4.1	27260700
eCl@ss 5.0	27260700
eCl@ss 5.1	27260700
eCl@ss 6.0	27260700
eCl@ss 7.0	27440309
eCl@ss 8.0	27440309
eCl@ss 9.0	27440309

ETIM

ETIM 3.0	EC001121
ETIM 4.0	EC002637
ETIM 5.0	EC002638
ETIM 6.0	EC002638
ETIM 7.0	EC002638

UNSPSC

UNSPSC 6.01	30211810
UNSPSC 7.0901	39121409
UNSPSC 11	39121409
UNSPSC 12.01	39121409
UNSPSC 13.2	39121409
UNSPSC 18.0	39121409

# Printed-circuit board connector - ZEC 1,5/ 8-ST-5,0 C2 R1,8 - 1883103

## Classifications

### UNSPSC

UNSPSC 19.0	39121409
UNSPSC 20.0	39121409
UNSPSC 21.0	39121409

## Approvals

### Approvals

#### Approvals

CCA / IEC EE CB Scheme / VDE Gutachten mit Fertigungsüberwachung / EAC / cULus Recognized

#### Ex Approvals

### Approval details

CCA	DE1 34215
Nominal voltage UN	1000 V
Nominal current IN	10 A

IECEE CB Scheme		<a href="http://www.iecee.org/">http://www.iecee.org/</a>	DE1-51128
Nominal voltage UN	1000 V		
Nominal current IN	10 A		

VDE Gutachten mit Fertigungsüberwachung		<a href="http://www2.vde.com/de/Institut/Online-Service/VDE-gepruefteProdukte/Seiten/Online-Suche.aspx">http://www2.vde.com/de/Institut/Online-Service/VDE-gepruefteProdukte/Seiten/Online-Suche.aspx</a>	40020343
Nominal voltage UN	250 V		
Nominal current IN	10 A		
mm <sup>2</sup> /AWG/kcmil	0.2-1.5		

EAC		B.01687
-----	---	---------

# Printed-circuit board connector - ZEC 1,5/ 8-ST-5,0 C2 R1,8 - 1883103

## Approvals

cULus Recognized		<a href="http://database.ul.com/cgi-bin/XYV/template/LISEXT/1FRAME/index.htm">http://database.ul.com/cgi-bin/XYV/template/LISEXT/1FRAME/index.htm</a> E60425-19941110
	B	D
Nominal voltage UN	300 V	300 V
Nominal current IN	10 A	10 A
mm <sup>2</sup> /AWG/kcmil	26-14	26-14

## Accessories

### Accessories

#### Labeled terminal marker

Marker card - SK 5/3,8:FORTL.ZAHLEN - 0804183



Marker card, Card, white, labeled, horizontal: consecutive numbers 1 ... 10, 11 ... 20, etc. up to 91 ... (99)100, mounting type: adhesive, for terminal block width: 5 mm, lettering field size: 5 x 3.8 mm

#### Screwdriver tools

Screwdriver - SZF 0-0,4X2,5 - 1204504



Actuation tool, for ST terminal blocks, also suitable for use as a bladed screwdriver, size: 0.4 x 2.5 x 75 mm, 2-component grip, with non-slip grip

Phoenix Contact 2020 © - all rights reserved  
<http://www.phoenixcontact.com>

PHOENIX CONTACT GmbH & Co. KG  
Flachsmarktstr. 8  
32825 Blomberg  
Germany  
Tel. +49 5235 300  
Fax +49 5235 3 41200  
<http://www.phoenixcontact.com>

## X-ON Electronics

Largest Supplier of Electrical and Electronic Components

*Click to view similar products for [Pluggable Terminal Blocks](#) category:*

*Click to view products by [Phoenix Contact](#) manufacturer:*

Other Similar products are found below :

[57.510.0053](#) [MC 1.5/ 6-ST-3.5 GY AU](#) [734-104](#) [734-302](#) [8-141-P](#) [8426620000](#) [860505](#) [860810](#) [GBPACX-12](#) [93.731.4953.0](#) [PV05-5,08-K](#)  
[PVP02-5,00](#) [PVP03-3,50](#) [PVP04-3,50](#) [PVS02-5,00](#) [1-1986160-3](#) [1377680000](#) [1531000000](#) [1546228-5](#) [ELFH16150](#) [ELFP03110](#)  
[ELFP10210](#) [ELFT06250](#) [ELVP03100](#) [1700101](#) [1700410](#) [1700425](#) [1702246](#) [1705229](#) [1710175](#) [1714537](#) [1717806](#) [1719600](#) [1728941](#)  
[1734692](#) [1734795](#) [1736036](#) [1740194](#) [1740291](#) [1740628](#) [1740990](#) [1746952](#) [1750207](#) [1752441](#) [1752865](#) [1754115](#) [1754144](#) [1756913](#)  
[1760051](#) [1760336](#)