

# PCB terminal block - FFKDSA1/H1-5,08- 8 - 1890358

Please be informed that the data shown in this PDF Document is generated from our Online Catalog. Please find the complete data in the user's documentation. Our General Terms of Use for Downloads are valid (<http://phoenixcontact.com/download>)

PCB terminal block, nominal current: 15 A, rated voltage (III/2): 400 V, nominal cross section: 1.5 mm<sup>2</sup>, pitch: 5.08 mm, number of positions: 8, connection method: Push-in spring connection, mounting: Wave soldering, conductor/PCB connection direction: 0 °, color: green, Pin layout: Linear double pinning, Solder pin [P]: 3.4 mm



The figure shows the 10-position version

## Your advantages

- Time saving push-in connection, tools not required
- Defined contact force ensures that contact remains stable over the long term
- Intuitive use through colour coded actuation lever
- Operation and conductor connection from one direction enable integration into front of device
- Two solder pins reduce the mechanical strain on the soldering spots
- The latching on the side enables various numbers of positions to be combined



## Key Commercial Data

Packing unit	50 pc
GTIN	
GTIN	4017918394011

## Technical data

### Item properties

Brief article description	PCB terminal block
Range of articles	FFKDS(A)/H1
Pitch	5.08 mm
Number of positions	8
Connection method	Push-in spring connection
Mounting type	Wave soldering
Pin layout	Linear double pinning
Number of levels	1
Number of connections	8

# PCB terminal block - FFKDSA1/H1-5,08- 8 - 1890358

## Technical data

### Item properties

Number of potentials	8
----------------------	---

### Electrical parameters

Nominal current	15 A
Nom. voltage	400 V
Rated voltage	250 V
Rated voltage (III/2)	400 V
Rated voltage (II/2)	630 V
Rated surge voltage (III/3)	4 kV
Rated surge voltage (III/2)	4 kV
Rated surge voltage (II/2)	4 kV

### Connection capacity

Connection method	Push-in spring connection
pluggable	Yes
Conductor cross section solid	0.2 mm <sup>2</sup> ... 1.5 mm <sup>2</sup>
Conductor cross section flexible	0.2 mm <sup>2</sup> ... 1.5 mm <sup>2</sup>
Conductor cross section AWG / kcmil	24 ... 16
Conductor cross section flexible, with ferrule without plastic sleeve	0.25 mm <sup>2</sup> ... 0.75 mm <sup>2</sup>
Conductor cross section, flexible, with ferrule, with plastic sleeve	0.25 mm <sup>2</sup> ... 0.75 mm <sup>2</sup>
Stripping length	10 mm

### Material data - contact

Note	WEEE/RoHS-compliant, free of whiskers according to IEC 60068-2-82/ JEDEC JESD 201
Contact material	Cu alloy
Surface characteristics	Tin-plated
Metal surface terminal point (top layer)	Tin (5 - 7 µm Sn)
Metal surface terminal point (middle layer)	Nickel (2 - 3 µm Ni)
Metal surface soldering area (top layer)	Tin (5 - 7 µm Sn)
Metal surface soldering area (middle layer)	Nickel (2 - 3 µm Ni)

### Material data - housing

Housing color	green (6021)
Insulating material	PA
Insulating material group	I
CTI according to IEC 60112	600
Flammability rating according to UL 94	V0
Glow wire flammability index GWFI according to EN 60695-2-12	850
Glow wire ignition temperature GWIT according to EN 60695-2-13	775
Temperature for the ball pressure test according to EN 60695-10-2	125 °C

### Dimensions for the product

Length [ l ]	13.65 mm
--------------	----------

# PCB terminal block - FFKDSA1/H1-5,08- 8 - 1890358

## Technical data

### Dimensions for the product

Width [ w ]	43.18 mm
Height [ h ]	16.15 mm
Pitch	5.08 mm
Height (without solder pin)	12.75 mm
Solder pin [P]	3.4 mm
Pin spacing	7.62 mm
Pin dimensions	0.5 x 1 mm

### Dimensions for PCB design

Hole diameter	1.3 mm
Pin spacing	7.62 mm

### Packaging information

Type of packaging	packed in cardboard
Pieces per package	50
Denomination packing units	Pcs.

### Electrical tests

Rated current	15 A
Conductor cross section	1.5 mm <sup>2</sup>
Rated voltage (III/2)	400 V
Rated surge voltage (III/2)	4 kV

### Air clearances and creepage distances

Clearances and creepage distances	IEC 60947-1:2007-06 + A1:2010-12 + A2:2014-09
Specification	IEC 60947-1:2007-06 + A1:2010-12 + A2:2014-09
Minimum clearance - inhomogeneous field (III/3)	3 mm
Minimum clearance - inhomogeneous field (III/2)	3 mm
Minimum clearance - inhomogeneous field (II/2)	3 mm
Minimum creepage distance value (III/3)	3.2 mm
Minimum creepage distance value (III/2)	3 mm
Minimum creepage distance value (II/2)	3.2 mm

### Standards and Regulations

Connection in acc. with standard	EN-VDE
	CUL

### Environmental Product Compliance

China RoHS	Environmentally friendly use period: unlimited = EFUP-e
	No hazardous substances above threshold values

## Drawings

# PCB terminal block - FFKDSA1/H1-5,08- 8 - 1890358

Drilling diagram

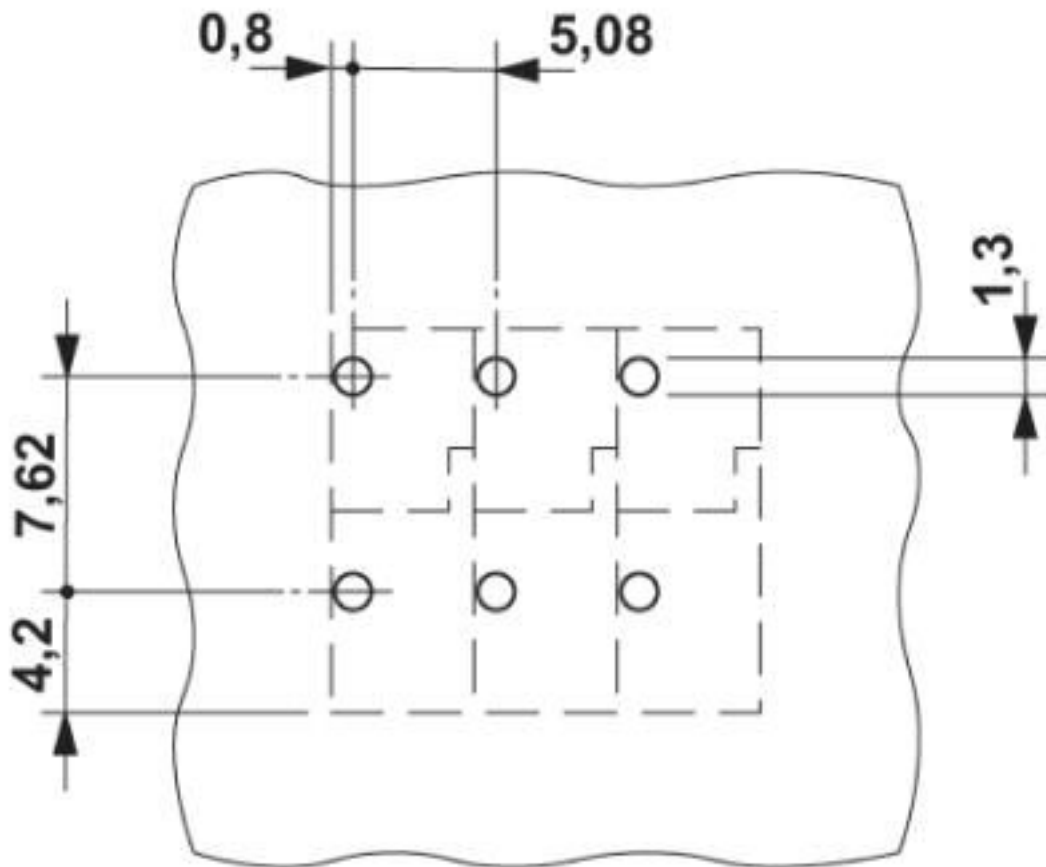

Dimensional drawing

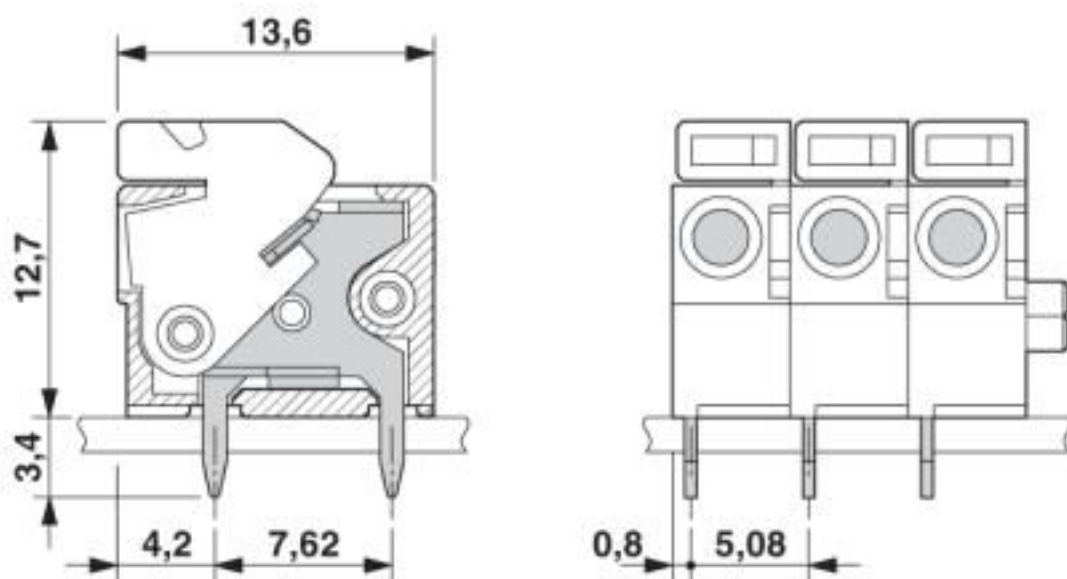

# PCB terminal block - FFKDSA1/H1-5,08- 8 - 1890358

## Classifications

### eCl@ss

eCl@ss 10.0.1	27440401
eCl@ss 4.0	27141100
eCl@ss 4.1	27141100
eCl@ss 5.0	27141100
eCl@ss 5.1	27261100
eCl@ss 6.0	27261100
eCl@ss 7.0	27440401
eCl@ss 8.0	27440401
eCl@ss 9.0	27440401

### ETIM

ETIM 3.0	EC001121
ETIM 4.0	EC002643
ETIM 5.0	EC002643
ETIM 6.0	EC002643
ETIM 7.0	EC002643

### UNSPSC

UNSPSC 6.01	30211801
UNSPSC 7.0901	39121432
UNSPSC 11	39121432
UNSPSC 12.01	39121432
UNSPSC 13.2	39121432
UNSPSC 18.0	39121432
UNSPSC 19.0	39121432
UNSPSC 20.0	39121432
UNSPSC 21.0	39121432

## Approvals

### Approvals

---

Approvals

EAC / cULus Recognized

---

Ex Approvals

---

### Approval details

# PCB terminal block - FFKDSA1/H1-5,08- 8 - 1890358

## Approvals

EAC		B.01687
-----	--	---------

cULus Recognized		<a href="http://database.ul.com/cgi-bin/XYV/template/LISEXT/1FRAME/index.htm">http://database.ul.com/cgi-bin/XYV/template/LISEXT/1FRAME/index.htm</a>	E60425-19870330
	B	D	
Nominal voltage UN	300 V	300 V	
Nominal current IN	10 A	10 A	
mm <sup>2</sup> /AWG/kcmil	24-16	24-16	

## Accessories

### Accessories

#### Labeled terminal marker

Marker card - SK 5,08/3,8:FORTL.ZAHLEN - 0804293



Marker card, Card, white, labeled, horizontal: consecutive numbers 1 ... 10, 11 ... 20, etc. up to 91 ... (99)100, mounting type: adhesive, for terminal block width: 5.08 mm, lettering field size: 5.08 x 3.8 mm

### Screwdriver tools

Screwdriver - SZF 1-0,6X3,5 - 1204517



Actuation tool, for ST terminal blocks, also suitable for use as a bladed screwdriver, size: 0.6 x 3.5 x 100 mm, 2-component grip, with non-slip grip

Phoenix Contact 2020 © - all rights reserved  
<http://www.phoenixcontact.com>

PHOENIX CONTACT GmbH & Co. KG  
Flachsmarktstr. 8  
32825 Blomberg  
Germany  
Tel. +49 5235 300  
Fax +49 5235 3 41200  
<http://www.phoenixcontact.com>

## X-ON Electronics

Largest Supplier of Electrical and Electronic Components

*Click to view similar products for [Fixed Terminal Blocks](#) category:*

*Click to view products by [Phoenix Contact](#) manufacturer:*

Other Similar products are found below :

[MBE-1512](#) [MBE-154](#) [MBE-156](#) [MBES-153](#) [MBES-156](#) [MH-2512](#) [MHE-132](#) [MHE-163](#) [MI-254 \(35\)](#) [MI-272](#) [880507](#) [MPT-275](#)  
[15602-04-08-21](#) [BA311TU](#) [BA411SU](#) [MV-152](#) [MV-252-D](#) [MV-253/NCNOC](#) [MV-254-D](#) [MV-255](#) [MV-462](#) [MV-493](#) [MVE-252](#) [MVE-253](#)  
[MVE-273](#) [MVEB-153](#) [1700096](#) [1705142](#) [1712417](#) [1713020](#) [1713088](#) [1745195](#) [1760594](#) [1776118-2](#) [1790852](#) [1-796689-8](#) [1-796692-6](#)  
[1800001](#) [1800114](#) [1995279](#) [20020314-C121B01LF](#) [CB2-12](#) [KP03215000J0G](#) [KP04215000J0G](#) [S451](#) [282802-2](#) [29.007](#) [29.116](#) [30.103](#)  
[30.106](#)