

PCB terminal block - MK3DS 3/ 3-5,08 BK - 1891373

Please be informed that the data shown in this PDF Document is generated from our Online Catalog. Please find the complete data in the user's documentation. Our General Terms of Use for Downloads are valid (<http://phoenixcontact.com/download>)

PCB terminal block, pitch: 5.08 mm, number of positions: 3, color: black, Pin layout: Linear pinning, Solder pin [P]: 5 mm. The article can be aligned to create different nos. of positions!



Key Commercial Data

Packing unit	1 pc
Minimum order quantity	50 pc
GTIN	 4 017918 414023
GTIN	4017918414023
Weight per Piece (excluding packing)	24.400 g
Custom tariff number	85369010
Country of origin	China

Technical data

Item properties

Number of positions	3
Drive form screw head	Slotted (L)
Screw thread	M3
Pin layout	Linear pinning

Material data - housing

Housing color	black (9005)
---------------	--------------

Dimensions for the product

Length [l]	33.6 mm
Width [w]	17.78 mm
Height [h]	49.8 mm
Pitch	5.08 mm
Height (without solder pin)	44.8 mm
Solder pin [P]	5 mm

Dimensions for PCB design

PCB terminal block - MK3DS 3/ 3-5,08 BK - 1891373

Technical data

Dimensions for PCB design

Hole diameter	1.3 mm
---------------	--------

Packaging information

Type of packaging	packed in cardboard
Pieces per package	50
Denomination packing units	Pcs.

Standards and Regulations

Connection in acc. with standard	EN-VDE
	CSA
Flammability rating according to UL 94	V0

Environmental Product Compliance

REACH SVHC	Lead 7439-92-1
China RoHS	Environmentally Friendly Use Period = 50 years
	For details about hazardous substances go to tab "Downloads", Category "Manufacturer's declaration"

Drawings

PCB terminal block - MK3DS 3/ 3-5,08 BK - 1891373

Drilling diagram

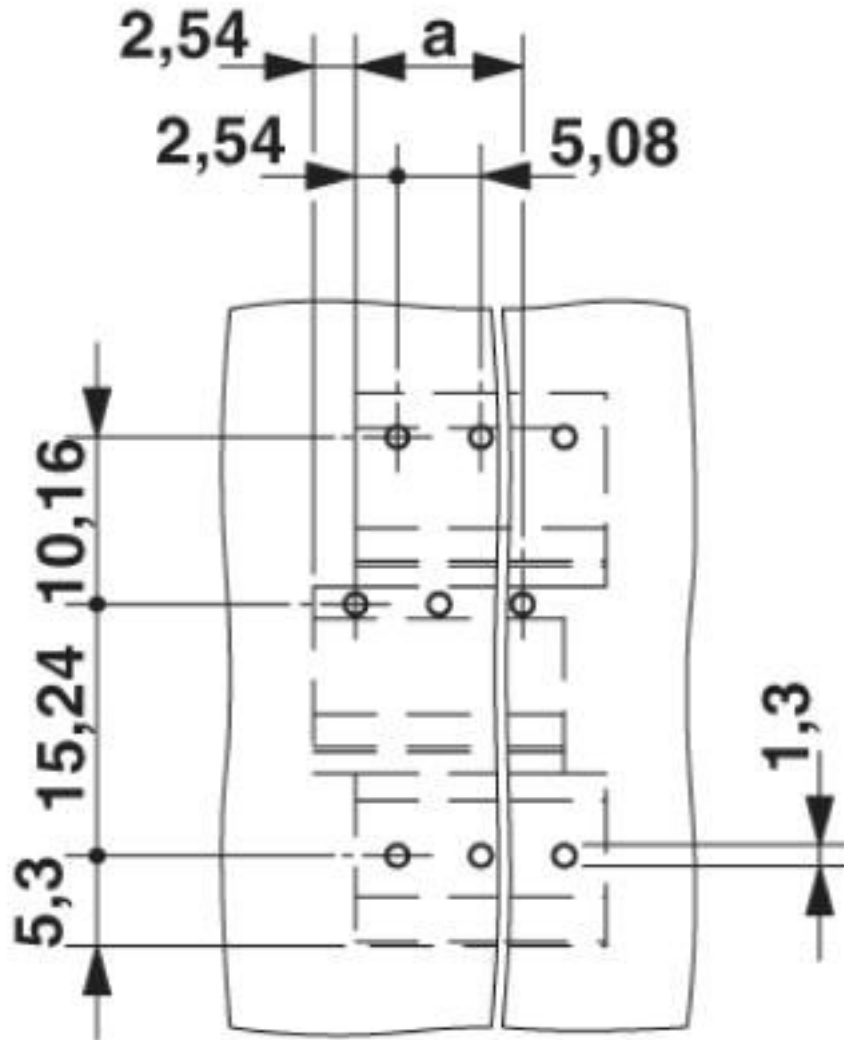

PCB terminal block - MK3DS 3/ 3-5,08 BK - 1891373

Dimensional drawing

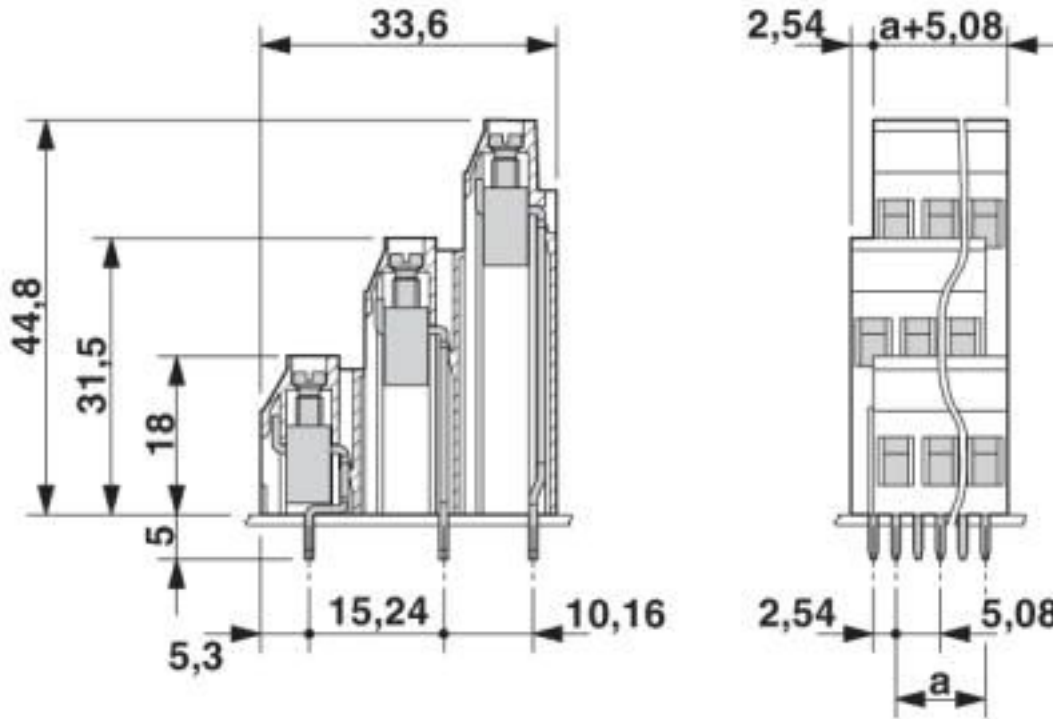

Classifications

eCl@ss

eCl@ss 10.0.1	27440401
eCl@ss 4.0	27141100
eCl@ss 4.1	27141100
eCl@ss 5.0	27141100
eCl@ss 5.1	27261100
eCl@ss 6.0	27261100
eCl@ss 7.0	27440401
eCl@ss 8.0	27440401
eCl@ss 9.0	27440401

ETIM

ETIM 3.0	EC001121
ETIM 4.0	EC002643
ETIM 5.0	EC002643
ETIM 6.0	EC002643
ETIM 7.0	EC002643

PCB terminal block - MK3DS 3/ 3-5,08 BK - 1891373

Classifications

UNSPSC

UNSPSC 6.01	30211801
UNSPSC 7.0901	39121432
UNSPSC 11	39121432
UNSPSC 12.01	39121432
UNSPSC 13.2	39121432
UNSPSC 18.0	39121432
UNSPSC 19.0	39121432
UNSPSC 20.0	39121432
UNSPSC 21.0	39121432

Approvals

Approvals

Approvals

CSA / UL Recognized / cUL Recognized / IECCEB Scheme / SEV / EAC / cULus Recognized

Ex Approvals

Approval details

CSA		http://www.csagroup.org/services-industries/product-listing/	13631
	B	D	
Nominal voltage UN	300 V	300 V	
Nominal current IN	10 A	10 A	
mm ² /AWG/kcmil	28-12	28-12	

UL Recognized		http://database.ul.com/cgi-bin/XYV/template/LISEXT/1FRAME/index.htm	FILE E 60425
	B	D	
Nominal voltage UN	125 V	300 V	
Nominal current IN	20 A	10 A	
mm ² /AWG/kcmil	30-12	30-12	

PCB terminal block - MK3DS 3/ 3-5,08 BK - 1891373

Approvals

cUL Recognized		http://database.ul.com/cgi-bin/XYV/template/LISEXT/1FRAME/index.htm	FILE E 60425
	B	D	
Nominal voltage UN	125 V	300 V	
Nominal current IN	20 A	10 A	
mm ² /AWG/kcmil	30-12	30-12	

IECEE CB Scheme		http://www.iecee.org/	CH-10724-A1
Nominal voltage UN	250 V		
Nominal current IN	24 A		
mm ² /AWG/kcmil	4		

SEV		https://www.eurofins.ch/de/	IK-4486-A1
Nominal voltage UN	250 V		
Nominal current IN	24 A		
mm ² /AWG/kcmil	4		

EAC		B.01687
-----	---	---------

cULus Recognized	
------------------	---

Accessories

Accessories

Bridge

PCB terminal block - MK3DS 3/ 3-5,08 BK - 1891373

Accessories

Insertion bridge - EBP 2- 5 - 1733169



Insertion bridge for connectors with 5.0 mm or 5.08 mm pitch

Insertion bridge - EBP 3- 5 - 1733172



Insertion bridge for connectors with 5.0 mm or 5.08 mm pitch

Cover

Cover - EA-MKDS - 1711408



Single cover for single and multi-level MKDS 3 PCB terminal blocks, for covering individual terminal positions, color: orange, transparent

Labeled terminal marker

Marker card - SK 5,08/3,8:FORTL.ZAHLEN - 0804293



Marker card, Card, white, labeled, horizontal: consecutive numbers 1 ... 10, 11 ... 20, etc. up to 91 ... (99)100, mounting type: adhesive, for terminal block width: 5.08 mm, lettering field size: 5.08 x 3.8 mm

Marker for terminal blocks - SK 5,08/3,8: 0-9 - 0804303



Marker for terminal blocks, Card, white, labeled, horizontal: consecutive numbers 0 ... 9, mounting type: adhesive, for terminal block width: 5.08 mm, lettering field size: 5.08 x 3.8 mm

PCB terminal block - MK3DS 3/ 3-5,08 BK - 1891373

Accessories

Marker pen

Marker pen - B-STIFT - 1051993



Marker pen, for manual labeling of unprinted Zack strips, smear-proof and waterproof, line thickness 0.5 mm

Screwdriver tools

Screwdriver - SZS 0,6X3,5 - 1205053



Actuation tool, for ST terminal blocks, insulated, also suitable for use as a bladed screwdriver, size: 0.6 x 3.5 x 100 mm, 2-component grip, with non-slip grip

Terminal marking

Marker card - SK 5,08/3,8:UNBEDRUCKT - 0805412



Marker card, Card, white, unlabeled, can be labeled with: Marker pen, mounting type: adhesive, for terminal block width: 5.08 mm, lettering field size: 5.08 x 3.8 mm

X-ON Electronics

Largest Supplier of Electrical and Electronic Components

Click to view similar products for [Fixed Terminal Blocks](#) category:

Click to view products by [Phoenix Contact](#) manufacturer:

Other Similar products are found below :

[00175550202](#) [MBE-1512](#) [MBE-1520](#) [MBE-154](#) [MBE-156](#) [MBES-1510](#) [MBES-153](#) [MBES-156](#) [MH-2512](#) [MHE-132](#) [MHE-133](#) [MHE-163](#)
[MI-254 \(35\)](#) [MI-272](#) [8739](#) [880507](#) [880508](#) [MPT-275](#) [1546551-6](#) [ELM023100](#) [ELM10110G](#) [ELVD12100](#) [BA311TU](#) [BA411SU](#) [MV-152](#)
[MV-253/NCNOC](#) [MV-254-D](#) [MV-255](#) [MV-462](#) [MV-472](#) [MV-493](#) [MVE-252](#) [MVE-253](#) [MVE-258](#) [MVE-273](#) [MVEB-153](#) [1700096](#)
[1702246](#) [1705142](#) [1712417](#) [1713020](#) [1713088](#) [1776118-2](#) [1790852](#) [1-796689-8](#) [1-796692-6](#) [1800001](#) [1800114](#) [1823215](#) [1838462](#)