

Feed-through header - EMC 1,5/ 2-GF-3,5 - 1897241

Please be informed that the data shown in this PDF Document is generated from our Online Catalog. Please find the complete data in the user's documentation. Our General Terms of Use for Downloads are valid (<http://phoenixcontact.com/download>)

PCB headers, nominal current: 8 A, rated voltage (III/2): 160 V, nominal cross section: 1.5 mm², number of positions: 2, pitch: 3.5 mm, color: green, contact surface: Tin, mounting: Press-in technology, pin layout: Linear pinning, solder pin [P]: 3.5 mm



The figure shows a 10-position version of the product

Your advantages

- Long-term stable press-in connection ensures high holding force without thermal load
- Screwable flange for superior mechanical stability
- Maximum flexibility when it comes to device design – one header for connectors with different connection technologies



Key Commercial Data

Packing unit	50 pc
GTIN	
GTIN	4017918165932

Technical data

Item properties

Brief article description	Feed-through header
Plug-in system	MINI COMBICON
Type of contact	Male connector
Range of articles	EMC 1,5/...-GF
Pitch	3.5 mm
Number of positions	2
Mounting type	Press-in technology
Pin layout	Linear pinning
Locking	Threaded flange
Number of levels	1
Number of connections	2
Number of potentials	2

Feed-through header - EMC 1,5/ 2-GF-3,5 - 1897241

Technical data

Electrical parameters

Nominal current	8 A
Nom. voltage	160 V
Rated voltage	160 V
Rated voltage (III/2)	160 V
Rated voltage (II/2)	250 V
Rated surge voltage (III/3)	2.5 kV
Rated surge voltage (III/2)	2.5 kV
Rated surge voltage (II/2)	2.5 kV

Material data - contact

Note	WEEE/RoHS-compliant, free of whiskers according to IEC 60068-2-82/ JEDEC JESD 201
Contact material	Cu alloy
Metal surface contact area (top layer)	Tin (1 - 2 µm Sn)
Metal surface contact area (middle layer)	Nickel (2 - 3 µm Ni),
Metal surface soldering area (top layer)	Tin (1 - 2 µm Sn)
Metal surface soldering area (middle layer)	Nickel (2 - 3 µm Ni)

Material data - housing

Housing color	green (6021)
Insulating material	PBT
Insulating material group	IIIa
CTI according to IEC 60112	225
Flammability rating according to UL 94	V0

Dimensions for the product

Length [L]	10.7 mm
Pitch	3.5 mm
Height (without solder pin)	7 mm
Solder pin [P]	3.5 mm
Pin dimensions	0.8 x 0.8 mm

Dimensions for PCB design

Hole diameter	1.45 mm
---------------	---------

Packaging information

Type of packaging	packed in cardboard
Pieces per package	50
Denomination packing units	Pcs.

Standards and Regulations

Connection in acc. with standard	EN-VDE
	CUL
Flammability rating according to UL 94	V0

Feed-through header - EMC 1,5/ 2-GF-3,5 - 1897241

Technical data

Environmental Product Compliance

REACH SVHC	Lead 7439-92-1
China RoHS	Environmentally Friendly Use Period = 50 years
	For details about hazardous substances go to tab "Downloads", Category "Manufacturer's declaration"

Drawings

Drilling diagram

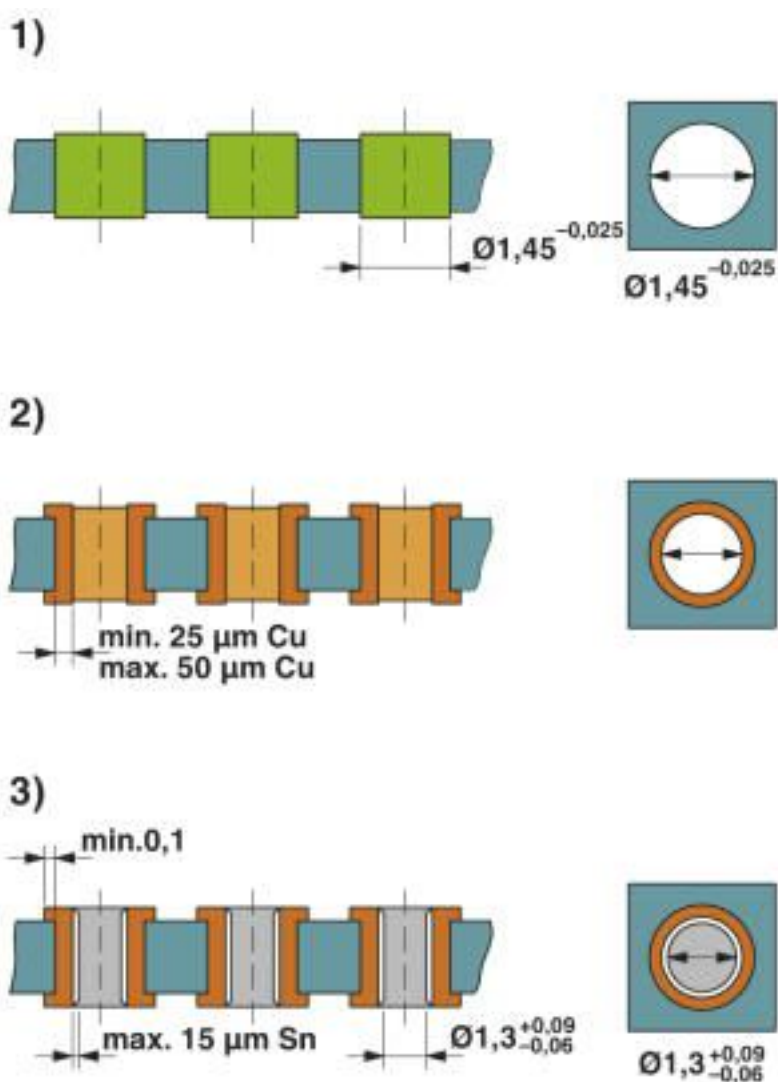

Drill hole layout in FR4 or EP-GC basic material

Feed-through header - EMC 1,5/ 2-GF-3,5 - 1897241

Drilling diagram

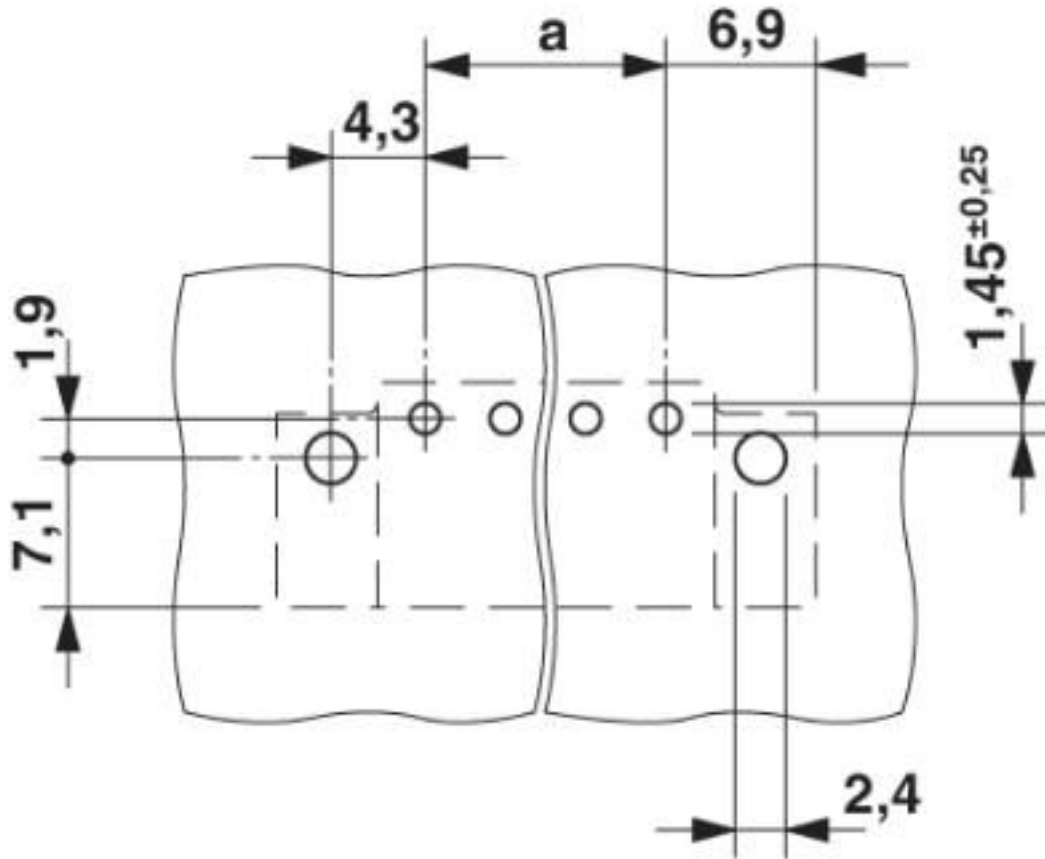

Dimensional drawing

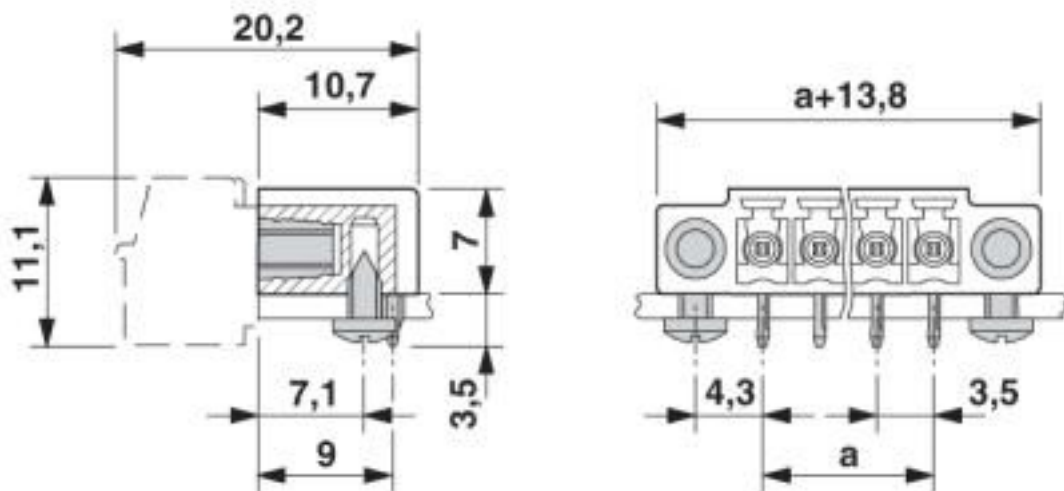

Feed-through header - EMC 1,5/ 2-GF-3,5 - 1897241

Classifications

eCl@ss

eCl@ss 4.0	27260700
eCl@ss 4.1	27260700
eCl@ss 5.0	27260700
eCl@ss 5.1	27260700
eCl@ss 6.0	27260700
eCl@ss 7.0	27440402
eCl@ss 8.0	27440402
eCl@ss 9.0	27440402

ETIM

ETIM 3.0	EC001121
ETIM 4.0	EC002637
ETIM 5.0	EC002637
ETIM 6.0	EC002637
ETIM 7.0	EC002637

UNSPSC

UNSPSC 6.01	30211810
UNSPSC 7.0901	39121409
UNSPSC 11	39121409
UNSPSC 12.01	39121409
UNSPSC 13.2	39121409
UNSPSC 19.0	39121409

Approvals

Approvals

Approvals

EAC / cULus Recognized

Ex Approvals

Approval details

EAC		B.01687
-----	---	---------

Feed-through header - EMC 1,5/ 2-GF-3,5 - 1897241

Approvals

cULus Recognized		http://database.ul.com/cgi-bin/XYV/template/LISEXT/1FRAME/index.htm	E60425-20110128
	B	D	
Nominal voltage UN	300 V	300 V	
Nominal current IN	8 A	8 A	

Accessories

Accessories

Coding element

Coding profile - CP-MSTB - 1734634



Coding profile, is inserted into the slot on the plug or inverted header, red insulating material

Labeled terminal marker

Marker card - SK 3,5/2,8:FORTL.ZAHLEN - 0804073



Marker card, Card, white, labeled, horizontal: consecutive numbers 1 ... 10, 11 ... 20, etc. up to 91 ... 99, mounting type: adhesive, for terminal block width: 3.5 mm, lettering field size: 3.5 x 2.8 mm

Assembly adapters - EMC 1,5-SH - 1877258



Stamp holder, for upper and lower stamp

Additional products

Feed-through header - EMC 1,5/ 2-GF-3,5 - 1897241

Accessories

Printed-circuit board connector - TFMC 1,5/ 2-STF-3,5 - 1772702



PCB connector, nominal current: 8 A, rated voltage (III/2): 160 V, nominal cross section: 1.5 mm², number of positions: 2, pitch: 3.5 mm, connection method: Push-in spring connection, color: green, contact surface: Tin

Printed-circuit board connector - MC 1,5/ 2-STF-3,5 - 1847055



PCB connector, nominal current: 8 A, rated voltage (III/2): 160 V, nominal cross section: 1.5 mm², number of positions: 2, pitch: 3.5 mm, connection method: Screw connection with tension sleeve, color: green, contact surface: Tin

Printed-circuit board connector - MCVW 1,5/ 2-STF-3,5 - 1863000



PCB connector, nominal current: 8 A, rated voltage (III/2): 160 V, nominal cross section: 1.5 mm², number of positions: 2, pitch: 3.5 mm, connection method: Screw connection with tension sleeve, color: green, contact surface: Tin

Printed-circuit board connector - MCVR 1,5/ 2-STF-3,5 - 1863301



PCB connector, nominal current: 8 A, rated voltage (III/2): 160 V, nominal cross section: 1.5 mm², number of positions: 2, pitch: 3.5 mm, connection method: Screw connection with tension sleeve, color: green, contact surface: Tin

Printed-circuit board connector - FK-MCP 1,5/ 2-STF-3,5 - 1940091



PCB connector, nominal current: 8 A, rated voltage (III/2): 160 V, nominal cross section: 1.5 mm², number of positions: 2, pitch: 3.5 mm, connection method: Push-in spring connection, color: green, contact surface: Tin

Feed-through header - EMC 1,5/ 2-GF-3,5 - 1897241

Accessories

Printed-circuit board connector - FMC 1,5/ 2-STF-3,5 - 1966091

PCB connector, nominal current: 8 A, rated voltage (III/2): 160 V, nominal cross section: 1.5 mm², number of positions: 2, pitch: 3.5 mm, connection method: Push-in spring connection, color: green, contact surface: Tin



Phoenix Contact 2020 © - all rights reserved
<http://www.phoenixcontact.com>

PHOENIX CONTACT GmbH & Co. KG
Flachsmarktstr. 8
32825 Blomberg
Germany
Tel. +49 5235 300
Fax +49 5235 3 41200
<http://www.phoenixcontact.com>

X-ON Electronics

Largest Supplier of Electrical and Electronic Components

Click to view similar products for [Pluggable Terminal Blocks](#) category:

Click to view products by [Phoenix Contact](#) manufacturer:

Other Similar products are found below :

[57.510.0053](#) [MC 1.5/ 6-ST-3.5 GY AU](#) [734-104](#) [734-302](#) [8-141-P](#) [8426620000](#) [860505](#) [860810](#) [GBPACX-12](#) [93.731.4953.0](#) [PV05-5,08-K](#)
[PVP02-5,00](#) [PVP03-3,50](#) [PVP04-3,50](#) [PVS02-5,00](#) [1-1986160-3](#) [1377680000](#) [1531000000](#) [1546228-5](#) [ELFH16150](#) [ELFP03110](#)
[ELFP10210](#) [ELFT06250](#) [ELVP03100](#) [1700101](#) [1700410](#) [1700425](#) [1702246](#) [1705229](#) [1710175](#) [1714537](#) [1717806](#) [1719600](#) [1728941](#)
[1734692](#) [1734795](#) [1736036](#) [1740194](#) [1740291](#) [1740628](#) [1740990](#) [1746952](#) [1750207](#) [1752441](#) [1752865](#) [1754115](#) [1754144](#) [1756913](#)
[1760051](#) [1760336](#)