

Printed-circuit board connector - FKCVW 2,5/14-ST - 1910157

Please be informed that the data shown in this PDF Document is generated from our Online Catalog. Please find the complete data in the user's documentation. Our General Terms of Use for Downloads are valid (<http://phoenixcontact.com/download>)

PCB connector, nominal current: 12 A, rated voltage (III/2): 320 V, nominal cross section: 2.5 mm², number of positions: 14, pitch: 5 mm, connection method: Push-in spring connection, color: green, contact surface: Tin



The figure shows a 10-position version of the product

Your advantages

- Time saving push-in connection, tools not required
- Intuitive use through colour coded actuation lever
- Quick and convenient testing using integrated test option
- Can be combined with the MSTB 2,5 range



Key Commercial Data

| | |
|--------------|---|
| Packing unit | 50 pc |
| GTIN |  4 017918 174934 |
| GTIN | 4017918174934 |

Technical data

Item properties

| | |
|---------------------------|---------------------------------|
| Brief article description | Printed-circuit board connector |
| Plug-in system | CLASSIC COMBICON |
| Type of contact | Female connector |
| Range of articles | FKCVW 2,5/...-ST |
| Pitch | 5 mm |
| Number of positions | 14 |
| Connection method | Push-in spring connection |
| Locking | without |
| Number of levels | 1 |
| Number of connections | 14 |
| Number of potentials | 14 |

Printed-circuit board connector - FKCVW 2,5/14-ST - 1910157

Technical data

Electrical parameters

| | |
|-----------------------------|-------|
| Nominal current | 12 A |
| Nom. voltage | 320 V |
| Rated voltage | 250 V |
| Rated voltage (III/2) | 320 V |
| Rated voltage (II/2) | 630 V |
| Rated surge voltage (III/3) | 4 kV |
| Rated surge voltage (III/2) | 4 kV |
| Rated surge voltage (II/2) | 4 kV |

Connection capacity

| | |
|---|--|
| Connection method | Push-in spring connection |
| pluggable | Yes |
| Conductor cross section solid | 0.2 mm ² ... 2.5 mm ² |
| Conductor cross section flexible | 0.2 mm ² ... 2.5 mm ² |
| Conductor cross section AWG / kcmil | 24 ... 12 |
| Conductor cross section flexible, with ferrule without plastic sleeve | 0.25 mm ² ... 2.5 mm ² |
| Conductor cross section, flexible, with ferrule, with plastic sleeve | 0.25 mm ² ... 2.5 mm ² |
| 2 conductors with the same cross section, flexible, with TWIN ferrule with plastic sleeve | 0.5 mm ² ... 1.5 mm ² |
| Stripping length | 10 mm |

Material data - contact

| | |
|--|---|
| Note | WEEE/RoHS-compliant, free of whiskers according to IEC 60068-2-82/ JEDEC JESD 201 |
| Contact material | Cu alloy |
| Surface characteristics | hot-dip tin-plated |
| Metal surface terminal point (top layer) | Tin (4 - 8 µm Sn) |
| Metal surface contact area (top layer) | Tin (4 - 8 µm Sn) |

Material data - housing

| | |
|---|--------------|
| Housing color | green (6021) |
| Insulating material | PA |
| Insulating material group | I |
| CTI according to IEC 60112 | 600 |
| Flammability rating according to UL 94 | V0 |
| Glow wire flammability index GWFI according to EN 60695-2-12 | 850 |
| Glow wire ignition temperature GWIT according to EN 60695-2-13 | 775 |
| Temperature for the ball pressure test according to EN 60695-10-2 | 125 °C |

Material data – actuating element

| | |
|--|-----|
| Insulating material | PBT |
| CTI according to IEC 60112 | 600 |
| Flammability rating according to UL 94 | V0 |

Printed-circuit board connector - FKCVW 2,5/14-ST - 1910157

Technical data

Dimensions for the product

| | |
|-----------------------------|---------|
| Length [l] | 26.6 mm |
| Width [w] | 70.1 mm |
| Height [h] | 19.2 mm |
| Pitch | 5 mm |
| Height (without solder pin) | 19.2 mm |

Packaging information

| | |
|----------------------------|---------------------|
| Type of packaging | packed in cardboard |
| Pieces per package | 50 |
| Denomination packing units | Pcs. |

General product information

| | |
|------|--|
| Note | In accordance with IEC 61984, COMBICON connectors have no switching power (COC). During designated use, they must not be plugged in or disconnected when carrying voltage or under load. |
|------|--|

Ambient conditions

| | |
|---|---|
| Ambient temperature (storage/transport) | -40 °C ... 70 °C |
| Ambient temperature (assembly) | -5 °C ... 100 °C |
| Ambient temperature (operation) | -40 °C ... 100 °C (dependent on the derating curve) |

Termination and connection method

| | |
|--|---------------------|
| Test – repeated connection and release | IEC 60999-1:1999-11 |
| | Test passed |
| Test for conductor damage and slackening | IEC 60999-1:1999-11 |
| | Test passed |

Pull-out test

| | |
|--|---|
| Pull-out test | IEC 60999-1:1999-11 |
| | Test passed |
| Conductor cross section / conductor type / tensile force | 0.2 mm ² / solid / > 10 N |
| | 0.2 mm ² / flexible / > 10 N |
| | 2.5 mm ² / solid / > 50 N |
| | 2.5 mm ² / flexible / > 50 N |

Mechanical tests according to standard

| | |
|-------------------------------------|------------------------|
| Test specification | IEC 61984 |
| Visual inspection | IEC 60512-1-1:2002-02 |
| Dimension check | IEC 60512-1-2:2002-02 |
| Resistance of inscriptions | IEC 60068-2-70:1995-12 |
| Insertion and withdrawal force | IEC 60512-13-2:2006-02 |
| No. of cycles | 25 |
| Insertion strength per pos. approx. | 8 N |
| Withdraw strength per pos. approx. | 6 N |
| Polarization and coding | IEC 60512-13-5:2006-02 |

Printed-circuit board connector - FKCVW 2,5/14-ST - 1910157

Technical data

Mechanical tests according to standard

| | |
|--------------------------|------------------------|
| Contact holder in insert | IEC 60512-15-1:2008-05 |
| Test force per pos. | 35 N |

Air clearances and creepage distances

| | |
|---|---------------------|
| Clearances and creepage distances | IEC 60664-1:2007-04 |
| Specification | IEC 60664-1:2007-04 |
| Minimum clearance - inhomogeneous field (III/3) | 3 mm |
| Minimum clearance - inhomogeneous field (III/2) | 3 mm |
| Minimum clearance - inhomogeneous field (II/2) | 3 mm |
| Minimum creepage distance value (III/3) | 3.2 mm |
| Minimum creepage distance value (III/2) | 1.6 mm |
| Minimum creepage distance value (II/2) | 3.2 mm |

Current carrying capacity / derating curves

| | |
|------------------|--|
| Caption | Type: FKCV(W/R) 2,5/...-ST with MSTB 2,5/...-G |
| Specification | IEC 61984:2008-10 |
| Reduction factor | 0.8 |
| Note | Representation based on IEC 60512-5-2:2002-02 |
| | For number of positions, see diagram |

Mechanical tests (A)

| | |
|--|-------------|
| Test specification | IEC 61984 |
| Insertion strength per pos. approx. | 8 N |
| Withdraw strength per pos. approx. | 6 N |
| Polarization when inserted requirement >20 N | Test passed |
| Contact holder in insert requirements >20 N | Test passed |

Durability tests (B)

| | |
|--|-----------------------|
| Specification | IEC 60512-9-1:2010-03 |
| Contact resistance R ₁ | 1 mΩ |
| Insertion/withdrawal cycles | 25 |
| Contact resistance R ₂ | 1.2 mΩ |
| Impulse withstand voltage at sea level | 4.8 kV |
| Power-frequency withstand voltage | 2.21 kV |
| Insulation resistance, neighboring positions | > 10 GΩ |

Thermal tests (C)

| | |
|---|-----------------------|
| Specification | IEC 60512-5-1:2002-02 |
| Number of positions | 18 |
| Conductor cross section | 2.5 mm ² |
| Test current | 12 A |
| Upper limiting temperature requirements <100 °C | Test passed |

Climatic tests (D)

Printed-circuit board connector - FKCVW 2,5/14-ST - 1910157

Technical data

Climatic tests (D)

| | |
|--|---|
| Specification | ISO 6988:1985-02 |
| Cold stress | -40 °C/2 h |
| Thermal stress | 100 °C/168 h |
| Corrosive stress | 0.2 dm ³ SO ₂ on 300 dm ³ /40 °C/1 cycle |
| Impulse withstand voltage at sea level | 4.8 kV |
| Power-frequency withstand voltage | 2.21 kV |

Environmental and durability tests (E)

| | |
|---------------------------------------|-------------------------------------|
| Specification | IEC 61984:2008-10 |
| Result, degree of protection, IP code | Finger safety with IP20 test finger |

Environmental Product Compliance

| | |
|------------|---|
| China RoHS | Environmentally friendly use period: unlimited = EFUP-e |
| | No hazardous substances above threshold values |

Drawings

Diagram

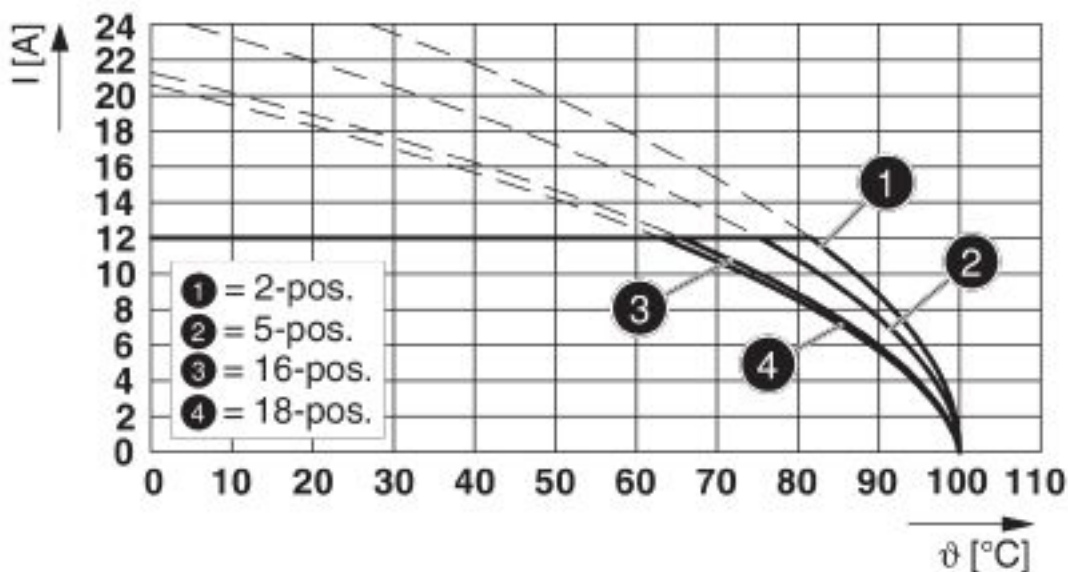

Type: FKCV(W/R) 2,5/...-ST with MSTB 2,5/...-G

Printed-circuit board connector - FKCVW 2,5/14-ST - 1910157

Diagram

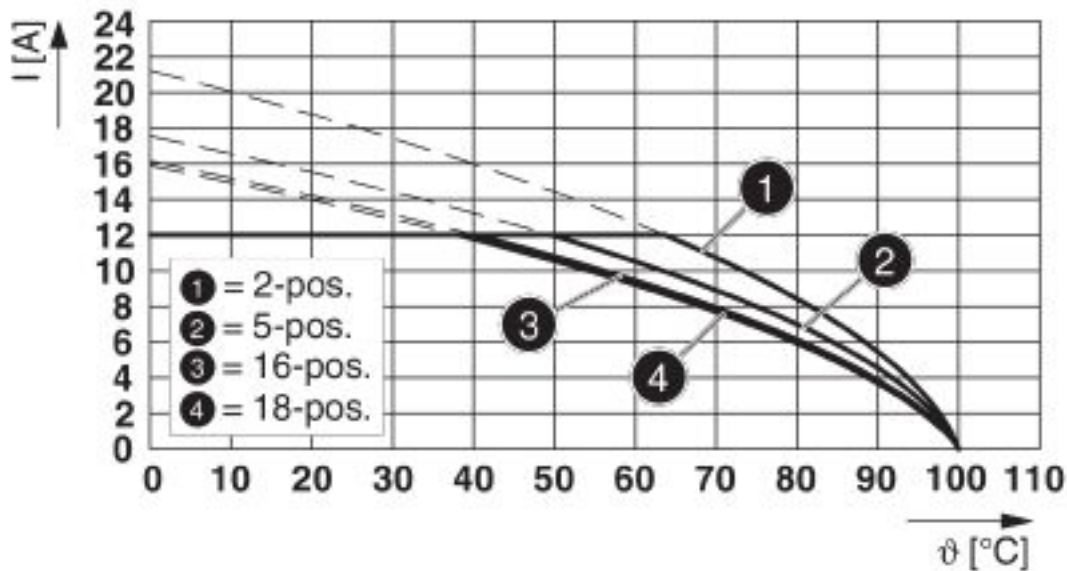

Type: FKCV(W/R) 2,5/...-ST with MSTBV 2,5/...-G

Diagram

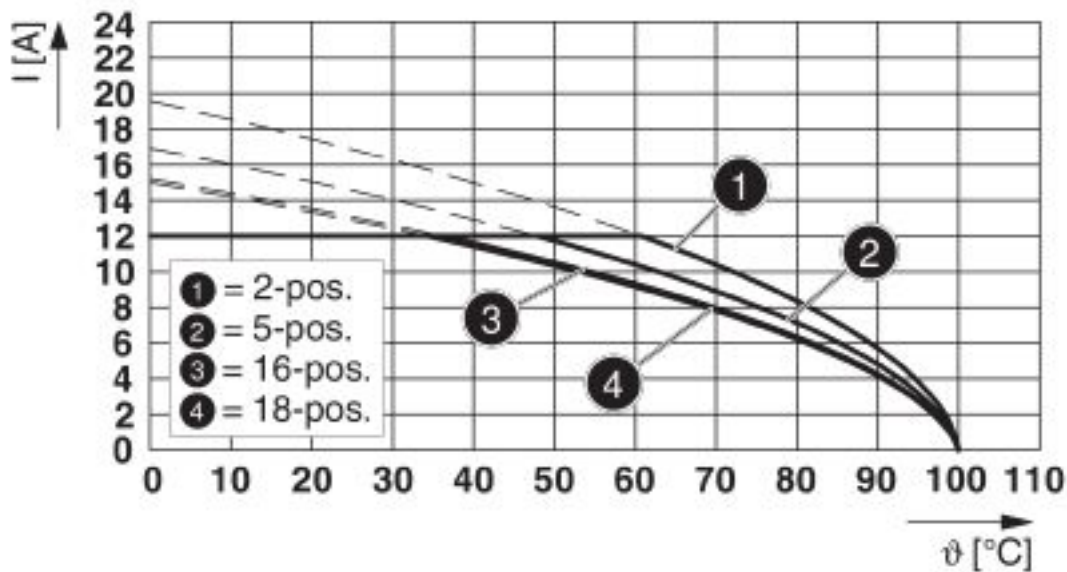

Type: FKCV(W/R) 2,5/...-ST with MSTBVA 2,5/...-G

Printed-circuit board connector - FKCVW 2,5/14-ST - 1910157

Diagram

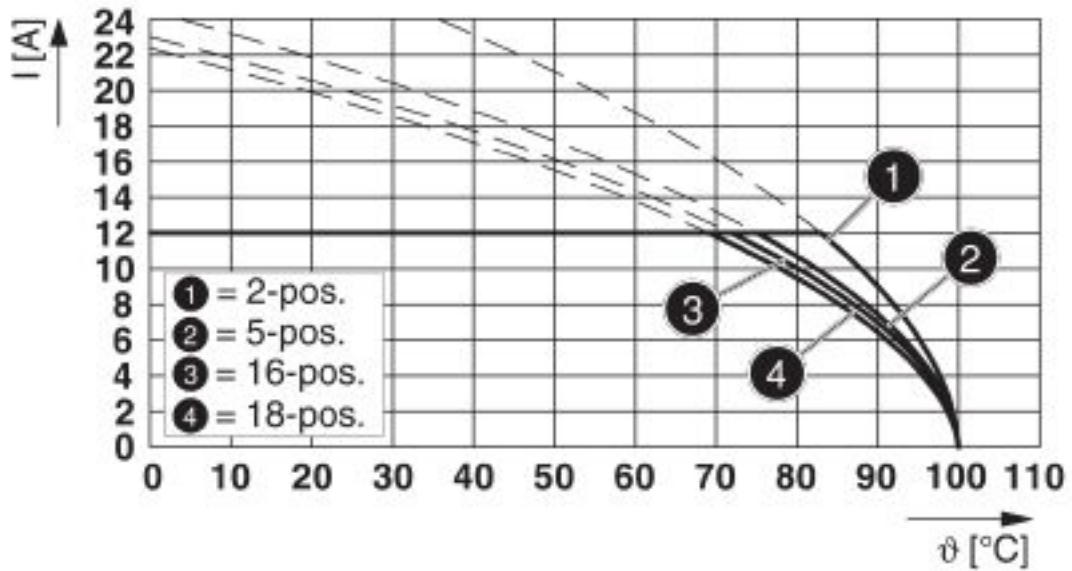

Type: FKCV(W/R) 2,5/...-ST with SMSTBA 2,5/...-G

Diagram

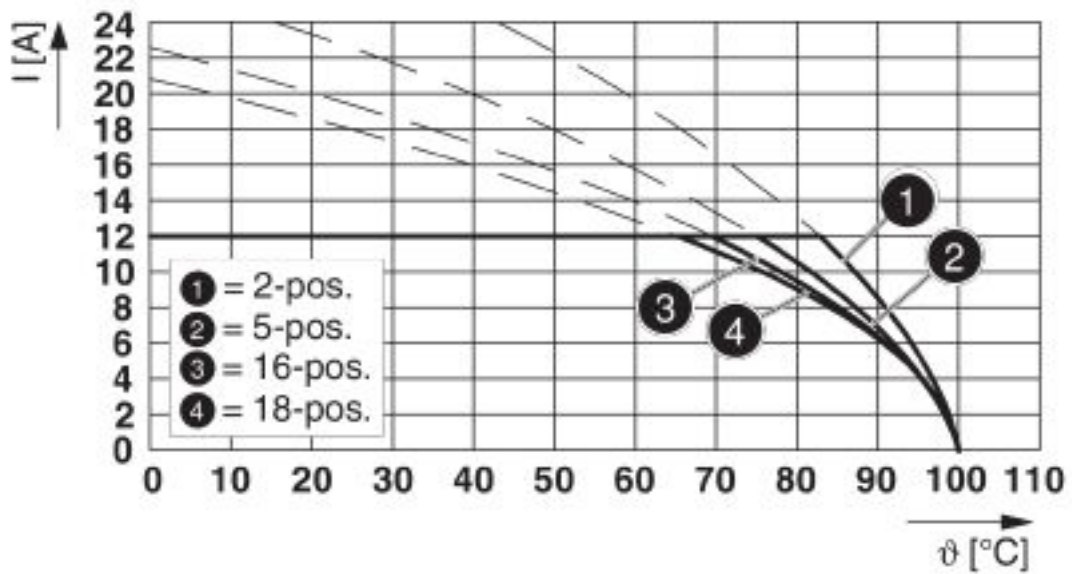

Type: FKCV(W/R) 2,5/...-ST with MSTBW 2,5/...-G

Printed-circuit board connector - FKCVW 2,5/14-ST - 1910157

Diagram

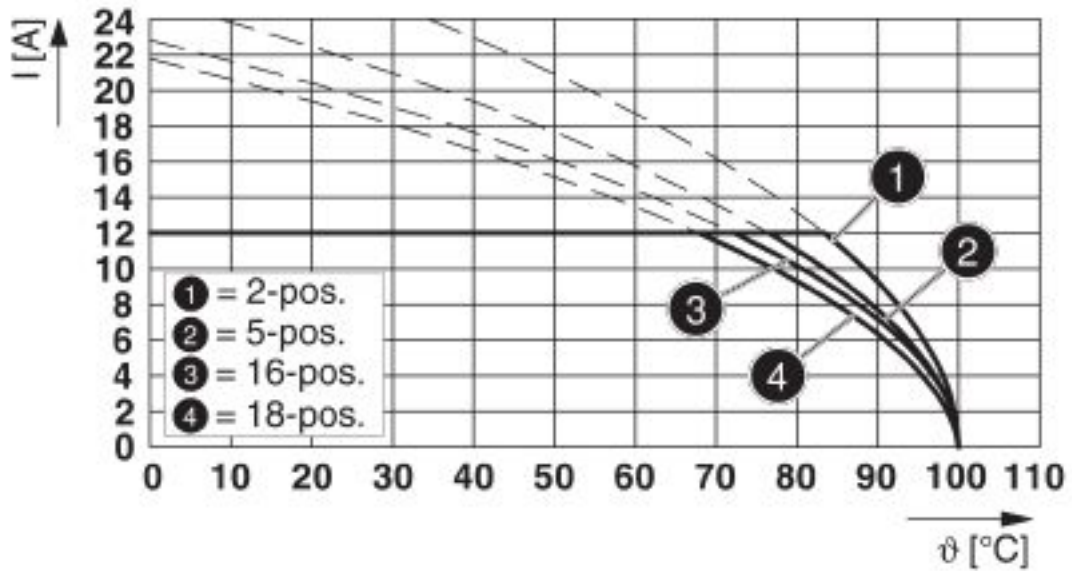

Type: FKCV(W/R) 2,5/...-ST with SMSTB 2,5/...-G

Diagram

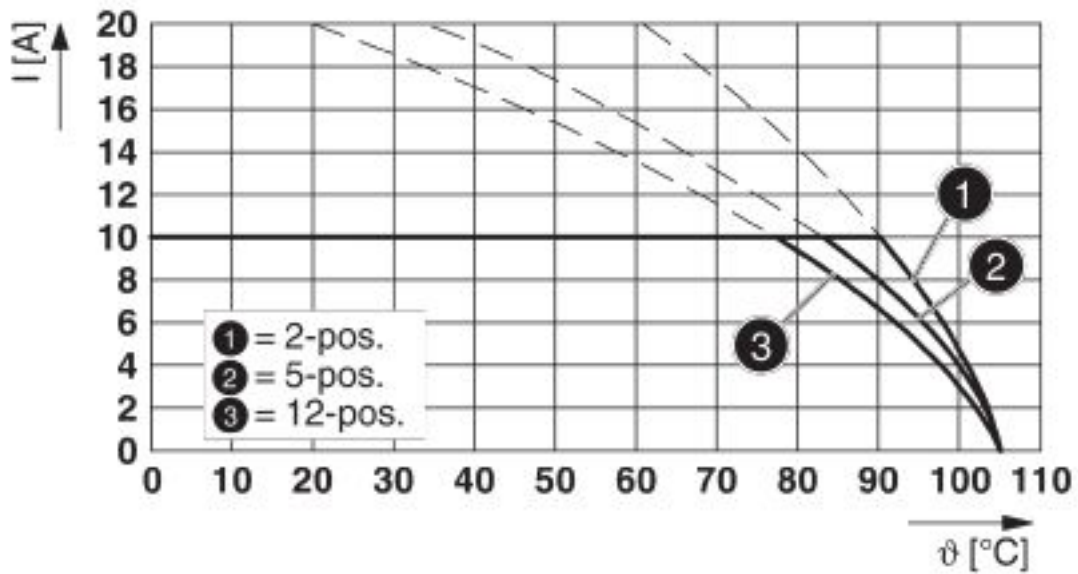

Type: FKCVW 2,5/...-ST with MDSTB 2,5/...-G

Printed-circuit board connector - FKCVW 2,5/14-ST - 1910157

Diagram

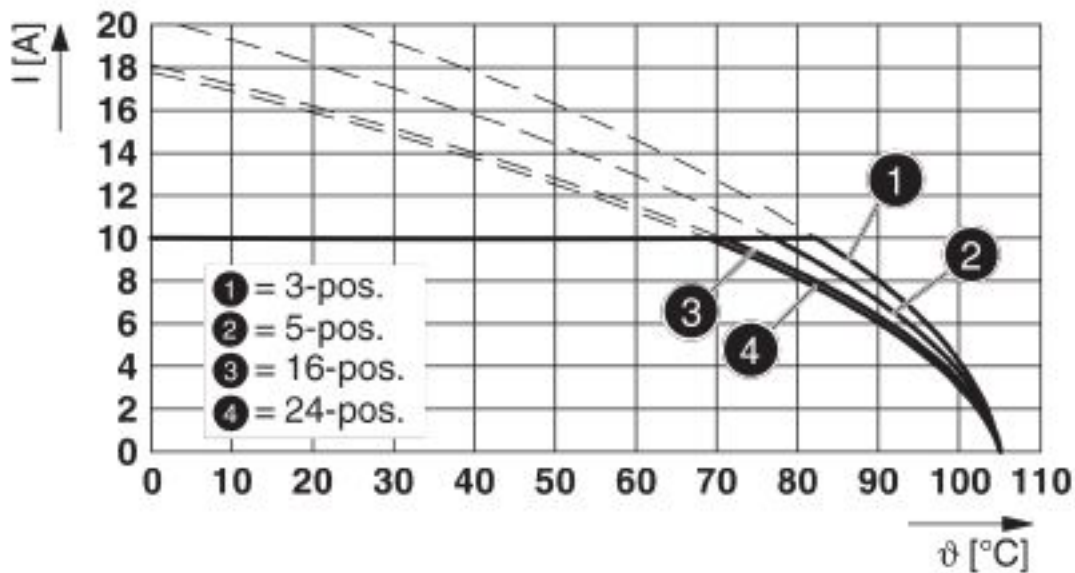

Type: FKCVW 2,5/...-ST with MDSTB 2,5/...-G1

Diagram

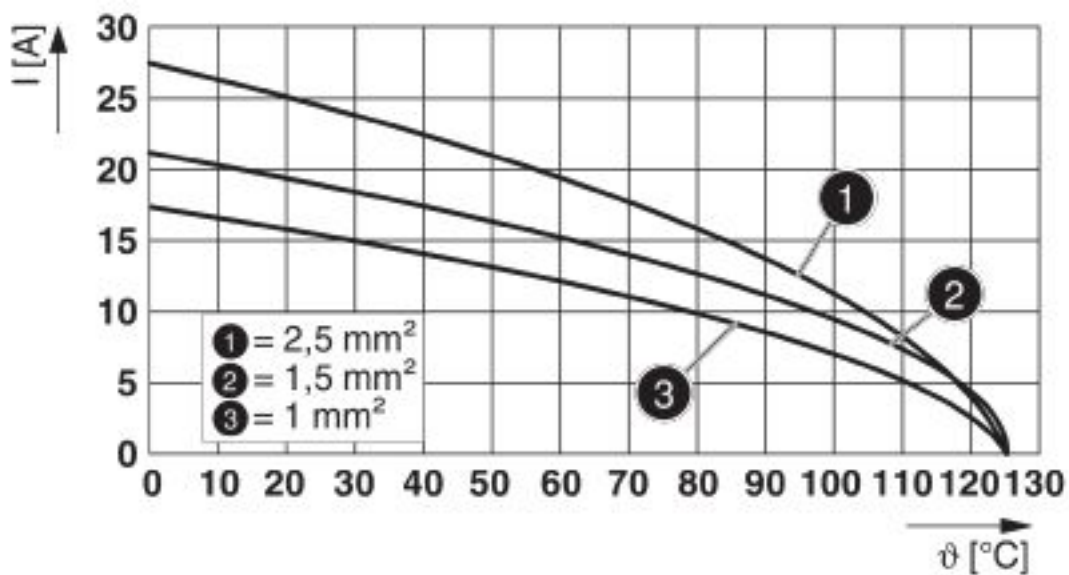

Type: FKCVW 2,5/...-ST with MDSTBA 2,5/...-G

Printed-circuit board connector - FKCVW 2,5/14-ST - 1910157

Diagram

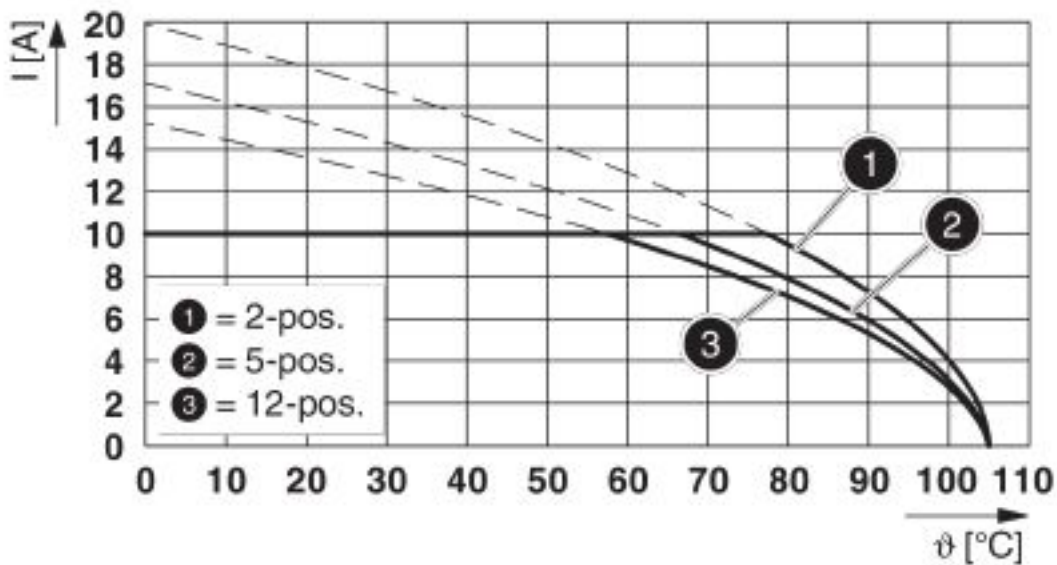

Type: FKCVW 2,5/...-ST with MDSTBV 2,5/...-G

Diagram

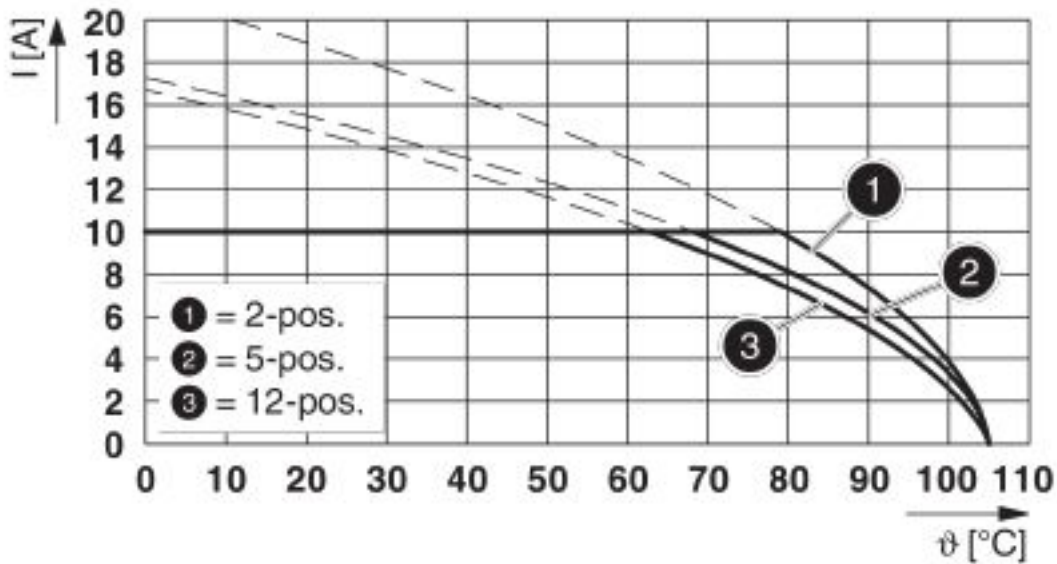

Type: FKCVW 2,5/...-ST with MDSTBVA 2,5/...-G

Printed-circuit board connector - FKCVW 2,5/14-ST - 1910157

Diagram

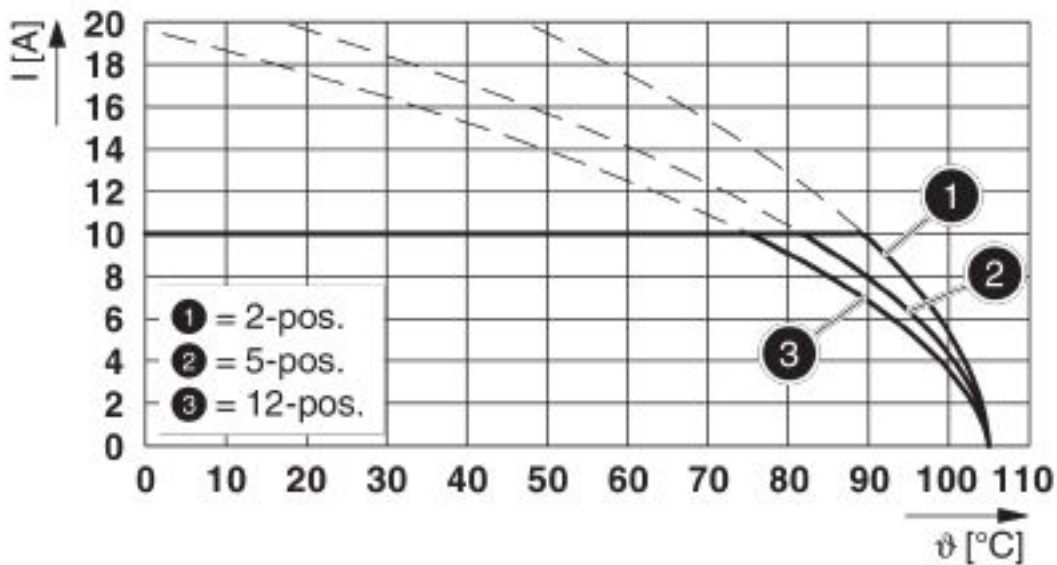

Type: FKCVW 2,5/...-ST with MDSTBW 2,5/...-G

Dimensional drawing

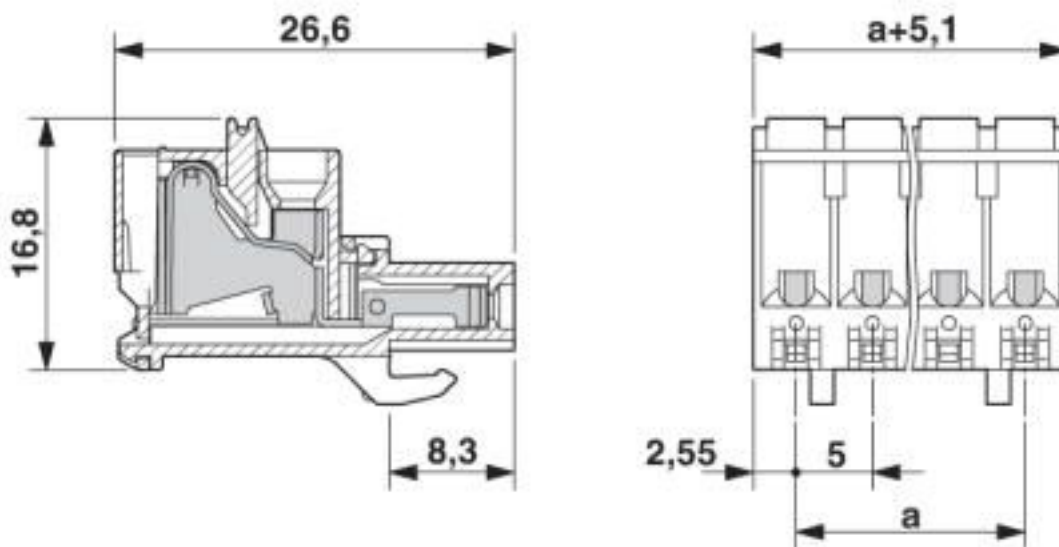

Classifications

eCl@ss

| | |
|---------------|----------|
| eCl@ss 10.0.1 | 27440309 |
| eCl@ss 4.0 | 27260700 |
| eCl@ss 4.1 | 27260700 |
| eCl@ss 5.0 | 27260700 |
| eCl@ss 5.1 | 27260700 |

Printed-circuit board connector - FKCVW 2,5/14-ST - 1910157

Classifications

eCl@ss

| | |
|------------|----------|
| eCl@ss 6.0 | 27260700 |
| eCl@ss 7.0 | 27440309 |
| eCl@ss 8.0 | 27440309 |
| eCl@ss 9.0 | 27440309 |

ETIM

| | |
|----------|----------|
| ETIM 3.0 | EC001121 |
| ETIM 4.0 | EC002638 |
| ETIM 5.0 | EC002638 |
| ETIM 6.0 | EC002638 |
| ETIM 7.0 | EC002638 |

UNSPSC

| | |
|---------------|----------|
| UNSPSC 6.01 | 30211810 |
| UNSPSC 7.0901 | 39121409 |
| UNSPSC 11 | 39121409 |
| UNSPSC 12.01 | 39121409 |
| UNSPSC 13.2 | 39121409 |
| UNSPSC 18.0 | 39121409 |
| UNSPSC 19.0 | 39121409 |
| UNSPSC 20.0 | 39121409 |
| UNSPSC 21.0 | 39121409 |

Approvals

Approvals

Approvals

IECEE CB Scheme / EAC / cULus Recognized / VDE Zeichengenehmigung

Ex Approvals

Approval details

| | | | |
|--------------------|---|---|----------------|
| IECEE CB Scheme |  | http://www.iecee.org/ | DE1-60988-B1B2 |
| Nominal voltage UN | 250 V | | |
| Nominal current IN | 12 A | | |

Printed-circuit board connector - FKCVW 2,5/14-ST - 1910157

Approvals

| | |
|---------------|---------|
| mm²/AWG/kcmil | 0.2-2.5 |
|---------------|---------|

| | | |
|-----|--|---------|
| EAC | | B.01687 |
|-----|--|---------|

| | | | |
|------------------|--|---|-----------------|
| cULus Recognized | | http://database.ul.com/cgi-bin/XYV/template/LISEXT/1FRAME/index.htm | E60425-19931011 |
|------------------|--|---|-----------------|

| | B | D |
|--------------------|-------|-------|
| Nominal voltage UN | 300 V | 300 V |
| Nominal current IN | 10 A | 10 A |
| mm²/AWG/kcmil | 26-12 | 26-12 |

| | | | |
|------------------------|--|---|----------|
| VDE Zeichengenehmigung | | http://www2.vde.com/de/Institut/Online-Service/VDE-gepruefteProdukte/Seiten/Online-Suche.aspx | 40004701 |
|------------------------|--|---|----------|

| | |
|--------------------|---------|
| Nominal voltage UN | 250 V |
| Nominal current IN | 12 A |
| mm²/AWG/kcmil | 0.2-2.5 |

Accessories

Accessories

Coding element

Coding profile - CP-MSTB - 1734634

Coding profile, is inserted into the slot on the plug or inverted header, red insulating material



Labeled terminal marker

Marker card - SK 5/3,8:FORTL.ZAHLEN - 0804183

Marker card, Card, white, labeled, horizontal: consecutive numbers 1 ... 10, 11 ... 20, etc. up to 91 ... (99)100, mounting type: adhesive, for terminal block width: 5 mm, lettering field size: 5 x 3.8 mm



Printed-circuit board connector - FKCVW 2,5/14-ST - 1910157

Accessories

Screwdriver tools

Screwdriver - SZS 0,6X3,5 - 1205053



Actuation tool, for ST terminal blocks, insulated, also suitable for use as a bladed screwdriver, size: 0.6 x 3.5 x 100 mm, 2-component grip, with non-slip grip

Strain relief

Strain relief - STZ 4-FKC-5,08 - 1876877



Strain relief for snapping into the latching chambers of the plugs, 4-pos.

Strain relief - STZ 8-FKC-5,08 - 1876880



Strain relief for snapping into the latching chambers of the plug components, 8-pos.

Test plug terminal block

Test plugs - MPS-MT - 0201744



Test plugs, with solder connection up to 1 mm² conductor cross section, color: gray

Reducing plug - RPS - 0201647



Reducing plug, color: gray

Additional products

Printed-circuit board connector - FKCVW 2,5/14-ST - 1910157

Accessories

Feed-through header - MSTBW 2,5/14-G - 1735992

PCB headers, nominal current: 12 A, rated voltage (III/2): 320 V, nominal cross section: 2.5 mm², number of positions: 14, pitch: 5 mm, color: green, contact surface: Tin, mounting: Wave soldering, pin layout: Linear pinning, solder pin [P]: 3.5 mm



Feed-through header - MSTBV 2,5/14-G - 1753673

PCB headers, nominal current: 12 A, rated voltage (III/2): 320 V, nominal cross section: 2.5 mm², number of positions: 14, pitch: 5 mm, color: green, contact surface: Tin, mounting: Wave soldering, pin layout: Linear pinning, solder pin [P]: 3.9 mm



Feed-through header - MSTB 2,5/14-G - 1754672

PCB headers, nominal current: 12 A, rated voltage (III/2): 320 V, nominal cross section: 2.5 mm², number of positions: 14, pitch: 5 mm, color: green, contact surface: Tin, mounting: Wave soldering, pin layout: Linear pinning, solder pin [P]: 3.5 mm



Printed-circuit board connector - MSTBVA 2,5/14-G - 1755626

PCB headers, nominal current: 12 A, rated voltage (III/2): 320 V, nominal cross section: 2.5 mm², number of positions: 14, pitch: 5 mm, color: green, contact surface: Tin, mounting: Wave soldering, pin layout: Linear pinning, solder pin [P]: 3.9 mm



Printed-circuit board connector - MSTBA 2,5/14-G - 1757585

PCB headers, nominal current: 12 A, rated voltage (III/2): 320 V, nominal cross section: 2.5 mm², number of positions: 14, pitch: 5 mm, color: green, contact surface: Tin, mounting: Wave soldering, pin layout: Linear pinning, solder pin [P]: 3.5 mm



Printed-circuit board connector - FKCVW 2,5/14-ST - 1910157

Accessories

Feed-through header - MDSTB 2,5/14-G1 - 1762813



PCB headers, nominal current: 10 A, rated voltage (III/2): 320 V, nominal cross section: 2.5 mm², number of positions: 14, pitch: 5 mm, color: green, contact surface: Tin, mounting: Wave soldering, pin layout: Linear pinning, solder pin [P]: 3.5 mm. In combination with MVSTB or FKCV plug components, both an MVSTBW (or FKCVW) and an MVSTBR plug (or FKCVR) must be used. Combination with TMSTBP plug components is not possible!

Feed-through header - MDSTBV 2,5/14-G1 - 1762965



PCB headers, nominal current: 10 A, rated voltage (III/2): 320 V, nominal cross section: 2.5 mm², number of positions: 14, pitch: 5 mm, color: green, contact surface: Tin, mounting: Wave soldering, pin layout: Linear pinning, solder pin [P]: 3.9 mm. In combination with MVSTB or FKCV plug components, both an MVSTBW (or FKCVW) and an MVSTBR plug (or FKCVR) must be used. Combination with TMSTBP plug components is not possible!

Feed-through header - MSTB 2,5/14-G-LA - 1768309



PCB headers, nominal current: 12 A, rated voltage (III/2): 320 V, nominal cross section: 2.5 mm², number of positions: 14, pitch: 5 mm, color: green, contact surface: Tin, mounting: Wave soldering, pin layout: Linear pinning, solder pin [P]: 3.5 mm

Printed-circuit board connector - SMSTB 2,5/14-G - 1769353



PCB headers, nominal current: 12 A, rated voltage (III/2): 320 V, nominal cross section: 2.5 mm², number of positions: 14, pitch: 5 mm, color: green, contact surface: Tin, mounting: Wave soldering, pin layout: Linear pinning, solder pin [P]: 3.5 mm

Feed-through header - SMSTBA 2,5/14-G - 1769926



PCB headers, nominal current: 12 A, rated voltage (III/2): 320 V, nominal cross section: 2.5 mm², number of positions: 14, pitch: 5 mm, color: green, contact surface: Tin, mounting: Wave soldering, pin layout: Linear pinning, solder pin [P]: 3.5 mm

Printed-circuit board connector - FKCVW 2,5/14-ST - 1910157

Accessories

Feed-through header - MSTBA 2,5/14-G-LA - 1770601



PCB headers, nominal current: 12 A, rated voltage (III/2): 320 V, nominal cross section: 2.5 mm², number of positions: 14, pitch: 5 mm, color: green, contact surface: Tin, mounting: Wave soldering, pin layout: Linear pinning, solder pin [P]: 3.2 mm

Phoenix Contact 2020 © - all rights reserved
<http://www.phoenixcontact.com>

PHOENIX CONTACT GmbH & Co. KG
Flachsmarktstr. 8
32825 Blomberg
Germany
Tel. +49 5235 300
Fax +49 5235 3 41200
<http://www.phoenixcontact.com>

X-ON Electronics

Largest Supplier of Electrical and Electronic Components

Click to view similar products for [Pluggable Terminal Blocks](#) category:

Click to view products by [Phoenix Contact](#) manufacturer:

Other Similar products are found below :

[57.510.0053](#) [MC 1.5/ 6-ST-3.5 GY AU](#) [734-104](#) [734-302](#) [8-141-P](#) [8426620000](#) [860505](#) [860810](#) [GBPACX-12](#) [93.731.4953.0](#) [PV05-5,08-K](#)
[PVP02-5,00](#) [PVP03-3,50](#) [PVP04-3,50](#) [PVS02-5,00](#) [1-1986160-3](#) [1377680000](#) [1531000000](#) [1546228-5](#) [ELFH16150](#) [ELFP03110](#)
[ELFP10210](#) [ELFT06250](#) [ELVP03100](#) [1700101](#) [1700410](#) [1700425](#) [1702246](#) [1705229](#) [1710175](#) [1714537](#) [1717806](#) [1719600](#) [1728941](#)
[1734692](#) [1734795](#) [1736036](#) [1740194](#) [1740291](#) [1740628](#) [1740990](#) [1746952](#) [1750207](#) [1752441](#) [1752865](#) [1754115](#) [1754144](#) [1756913](#)
[1760051](#) [1760336](#)