

# PCB connector - ZEC 1,0/ 8-LPV-3,5 C1 - 1915712

Please be informed that the data shown in this PDF Document is generated from our Online Catalog. Please find the complete data in the user's documentation. Our General Terms of Use for Downloads are valid (<http://phoenixcontact.com/download>)

PCB connector, nominal current: 8 A, rated voltage (III/2): 200 V, nominal cross section: 1 mm<sup>2</sup>, number of positions: 8, pitch: 3.5 mm, color: green, contact surface: Tin, mounting: Direct plug-in method



The figure shows a 10-position version of the product

## Your advantages

- Easy component connection
- Inexpensive direct plug-in connection with just one component



## Key Commercial Data

Packing unit	50 pc
GTIN	 4 017918 181468
GTIN	4017918181468

## Technical data

### Dimensions

Length	22.9 mm
Height	7 mm
Width	29.4 mm
Pitch	3.5 mm
Dimension a	28 mm

### General

Range of articles	ZEC 1,0/..-LPV
Insulating material group	I
Rated surge voltage (III/3)	2.5 kV
Rated surge voltage (III/2)	2.5 kV
Rated surge voltage (II/2)	2.5 kV
Rated voltage (III/2)	200 V

## PCB connector - ZEC 1,0/ 8-LPV-3,5 C1 - 1915712

### Technical data

#### General

Rated voltage (II/2)	320 V
Connection in acc. with standard	EN-VDE
Nominal current I <sub>N</sub>	8 A
Nominal voltage U <sub>N</sub>	160 V
Nominal cross section	1 mm <sup>2</sup>
Maximum load current	8 A
Insulating material	PA
Flammability rating according to UL 94	V0
Number of positions	8

#### Standards and Regulations

Connection in acc. with standard	EN-VDE
	CUL
Flammability rating according to UL 94	V0

#### Environmental Product Compliance

China RoHS	Environmentally friendly use period: unlimited = EFUP-e
	No hazardous substances above threshold values

### Drawings

# PCB connector - ZEC 1,0/ 8-LPV-3,5 C1 - 1915712

Drilling diagram

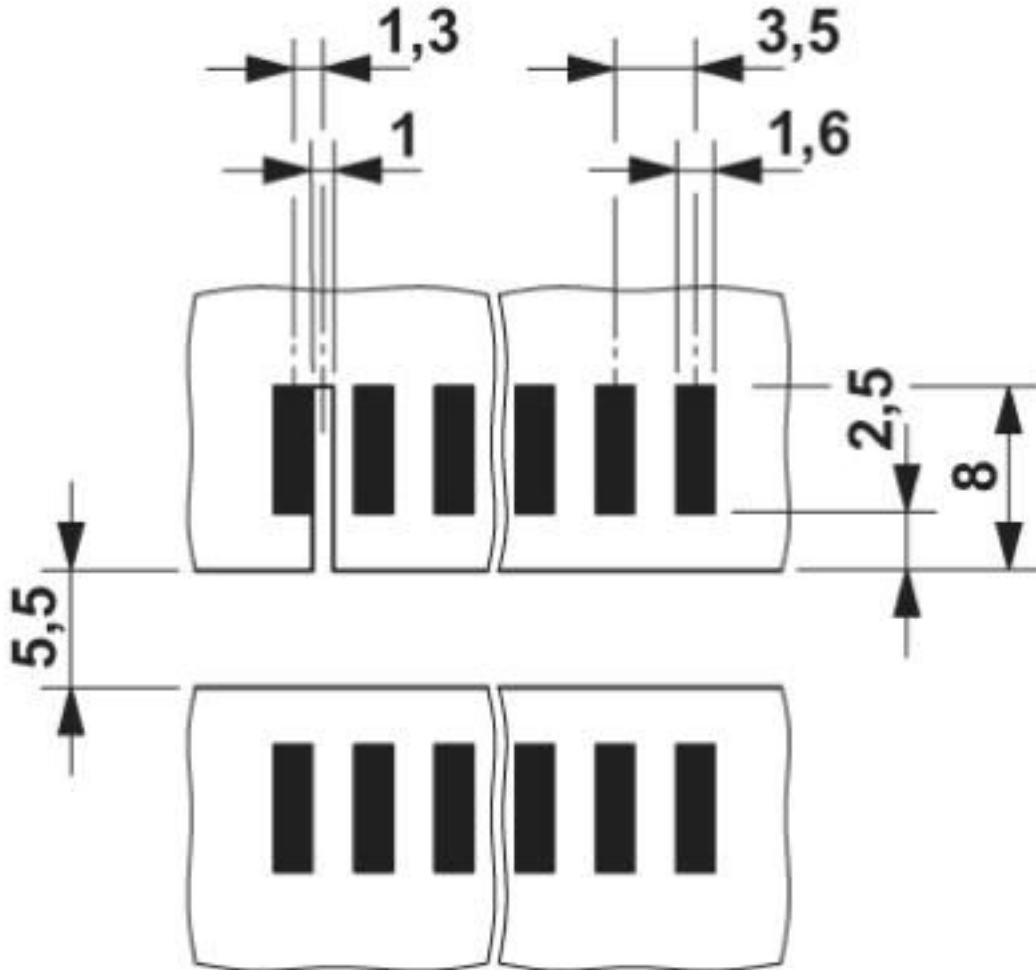

Size of the PCB:  $1.6 \pm 0.2$  mm

Dimensional drawing

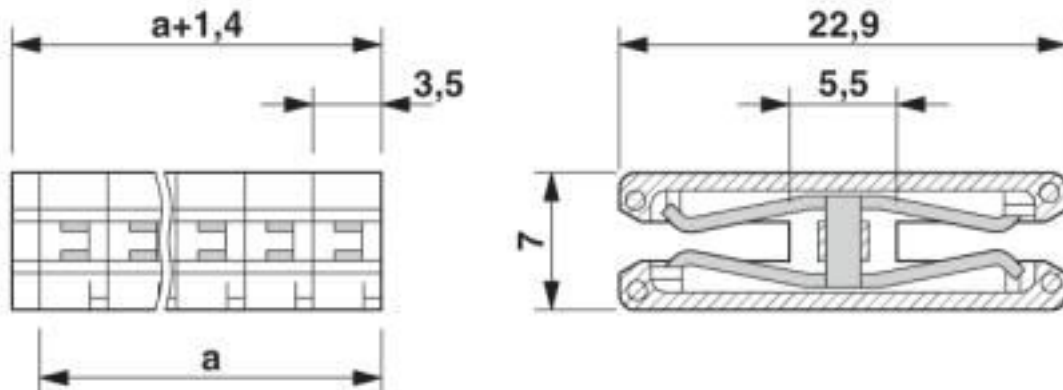

# PCB connector - ZEC 1,0/ 8-LPV-3,5 C1 - 1915712

## Classifications

### eCl@ss

eCl@ss 10.0.1	27440402
eCl@ss 4.0	27260700
eCl@ss 4.1	27260700
eCl@ss 5.0	27260700
eCl@ss 5.1	27260700
eCl@ss 6.0	27260700
eCl@ss 7.0	27440402
eCl@ss 8.0	27440402
eCl@ss 9.0	27440402

### ETIM

ETIM 3.0	EC001121
ETIM 4.0	EC002643
ETIM 5.0	EC002637
ETIM 6.0	EC002637
ETIM 7.0	EC002637

### UNSPSC

UNSPSC 6.01	30211810
UNSPSC 7.0901	39121409
UNSPSC 11	39121409
UNSPSC 12.01	39121409
UNSPSC 13.2	39121409
UNSPSC 18.0	39121409
UNSPSC 19.0	39121409
UNSPSC 20.0	39121409
UNSPSC 21.0	39121409

## Approvals

### Approvals

---

#### Approvals

CCA / IECCEB Scheme / VDE Gutachten mit Fertigungsüberwachung / EAC / cULus Recognized

---

#### Ex Approvals

---

### Approval details

# PCB connector - ZEC 1,0/ 8-LPV-3,5 C1 - 1915712

## Approvals

CCA	DE1 34215
Nominal voltage UN	1000 V
Nominal current IN	10 A

IECEE CB Scheme		<a href="http://www.iecee.org/">http://www.iecee.org/</a>	DE1-51128
Nominal voltage UN	1000 V		
Nominal current IN	10 A		

VDE Gutachten mit Fertigungsüberwachung		<a href="http://www2.vde.com/de/Institut/Online-Service/VDE-gepruefteProdukte/Seiten/Online-Suche.aspx">http://www2.vde.com/de/Institut/Online-Service/ VDE-gepruefteProdukte/Seiten/Online-Suche.aspx</a>	40020343
Nominal voltage UN	160 V		
Nominal current IN	8 A		

EAC		B.01687
-----	---	---------

cULus Recognized		<a href="http://database.ul.com/cgi-bin/XYV/template/LISEXT/1FRAME/index.htm">http://database.ul.com/cgi-bin/XYV/template/LISEXT/1FRAME/index.htm</a>	E60425-19941110
Nominal voltage UN	150 V		
Nominal current IN	8 A		

Phoenix Contact 2020 © - all rights reserved  
<http://www.phoenixcontact.com>

PHOENIX CONTACT GmbH & Co. KG  
 Flachsmarktstr. 8  
 32825 Blomberg  
 Germany  
 Tel. +49 5235 300  
 Fax +49 5235 3 41200  
<http://www.phoenixcontact.com>

## X-ON Electronics

Largest Supplier of Electrical and Electronic Components

*Click to view similar products for [Pluggable Terminal Blocks](#) category:*

*Click to view products by [Phoenix Contact](#) manufacturer:*

Other Similar products are found below :

[57.510.0053](#) [MC 1.5/ 6-ST-3.5 GY AU](#) [734-104](#) [734-302](#) [8-141-P](#) [8426620000](#) [860505](#) [860810](#) [GBPACX-12](#) [93.731.4953.0](#) [PV05-5,08-K](#)  
[PVP02-5,00](#) [PVP03-3,50](#) [PVP04-3,50](#) [PVS02-5,00](#) [1-1986160-3](#) [1377680000](#) [1531000000](#) [1546228-5](#) [ELFH16150](#) [ELFP03110](#)  
[ELFP10210](#) [ELFT06250](#) [ELVP03100](#) [1700101](#) [1700410](#) [1700425](#) [1702246](#) [1705229](#) [1710175](#) [1714537](#) [1717806](#) [1719600](#) [1728941](#)  
[1734692](#) [1734795](#) [1736036](#) [1740194](#) [1740291](#) [1740628](#) [1740990](#) [1746952](#) [1750207](#) [1752441](#) [1752865](#) [1754115](#) [1754144](#) [1756913](#)  
[1760051](#) [1760336](#)