

## Feed-through header - MSTBA 2,5 HC/ 5-G - 1923788

Please be informed that the data shown in this PDF Document is generated from our Online Catalog. Please find the complete data in the user's documentation. Our General Terms of Use for Downloads are valid (<http://phoenixcontact.com/download>)

PCB headers, nominal current: 16 A, rated voltage (III/2): 320 V, nominal cross section: 2.5 mm<sup>2</sup>, number of positions: 5, pitch: 5 mm, color: green, contact surface: Tin, mounting: Wave soldering, pin layout: Linear pinning, solder pin [P]: 3.5 mm



The figure shows a 10-position version of the product

### Your advantages

- Well-known mounting principle allows worldwide use
- Plug-in direction parallel to the PCB



### Key Commercial Data

Packing unit	50 pc
GTIN	 4 017918 599973
GTIN	4017918599973

### Technical data

#### Item properties

Brief article description	Feed-through header
Plug-in system	POWER COMBICON 2,5
Type of contact	Male connector
Range of articles	MSTBA 2,5 HC/...-G
Pitch	5 mm
Number of positions	5
Mounting type	Wave soldering
Pin layout	Linear pinning
Locking	without
Number of levels	1
Number of connections	5
Number of potentials	5

# Feed-through header - MSTBA 2,5 HC/ 5-G - 1923788

## Technical data

### Electrical parameters

Nominal current	16 A
Nom. voltage	320 V
Rated voltage	320 V
Rated voltage (III/2)	320 V
Rated voltage (II/2)	630 V
Rated surge voltage (III/3)	4 kV
Rated surge voltage (III/2)	4 kV
Rated surge voltage (II/2)	4 kV

### Material data - contact

Note	WEEE/RoHS-compliant, free of whiskers according to IEC 60068-2-82/ JEDEC JESD 201
Contact material	Cu alloy
Surface characteristics	Tin-plated
Metal surface contact area (top layer)	Tin (3 - 5 µm Sn)
Metal surface contact area (middle layer)	Nickel (1 - 3 µm Ni),
Metal surface soldering area (top layer)	Tin (3 - 5 µm Sn)
Metal surface soldering area (middle layer)	Nickel (1 - 3 µm Ni)

### Material data - housing

Housing color	green (6021)
Insulating material	PA
Insulating material group	I
CTI according to IEC 60112	600
Flammability rating according to UL 94	V0
Glow wire flammability index GWFI according to EN 60695-2-12	850
Glow wire ignition temperature GWIT according to EN 60695-2-13	775
Temperature for the ball pressure test according to EN 60695-10-2	125 °C

### Dimensions for the product

Length [ l ]	12 mm
Width [ w ]	27 mm
Height [ h ]	12.1 mm
Pitch	5 mm
Height (without solder pin)	8.6 mm
Solder pin [ P ]	3.5 mm
Pin spacing	5.00 mm
Pin dimensions	1 x 1 mm

### Dimensions for PCB design

Hole diameter	1.6 mm
Pin spacing	5.00 mm

### Packaging information

# Feed-through header - MSTBA 2,5 HC/ 5-G - 1923788

## Technical data

### Packaging information

Type of packaging	packed in cardboard
Pieces per package	50
Denomination packing units	Pcs.

### General product information

Note	In accordance with IEC 61984, COMBICON connectors have no switching power (COC). During designated use, they must not be plugged in or disconnected when carrying voltage or under load.
	In accordance with IEC 61984, COMBICON connectors have no switching power (COC). During designated use, they must not be plugged in or disconnected when carrying voltage or under load.

### Ambient conditions

Ambient temperature (storage/transport)	-40 °C ... 70 °C
Ambient temperature (assembly)	-5 °C ... 100 °C
Ambient temperature (operation)	-40 °C ... 100 °C (dependent on the derating curve)

### Air clearances and creepage distances

Clearances and creepage distances	IEC 60664-1:2007-04
Specification	IEC 60664-1:2007-04
Minimum clearance - inhomogeneous field (III/3)	3 mm
Minimum clearance - inhomogeneous field (III/2)	3 mm
Minimum clearance - inhomogeneous field (II/2)	3 mm
Minimum creepage distance value (III/3)	4 mm
Minimum creepage distance value (III/2)	1.6 mm
Minimum creepage distance value (II/2)	3.2 mm

### Mechanical tests (A)

Test specification	IEC 61984
Insertion strength per pos. approx.	6 N
Withdraw strength per pos. approx.	5 N
Polarization when inserted requirement >20 N	Test passed
Contact holder in insert requirements >20 N	Test passed

### Durability tests (B)

Specification	IEC 60512-9-1:2010-03
Contact resistance R <sub>1</sub>	1.1 mΩ
Insertion/withdrawal cycles	50
Contact resistance R <sub>2</sub>	1.2 mΩ
Impulse withstand voltage at sea level	4.8 kV
Power-frequency withstand voltage	2.21 kV
Insulation resistance, neighboring positions	15 TΩ

### Thermal tests (C)

Specification	IEC 60512-5-1:2002-02
---------------	-----------------------

## Feed-through header - MSTBA 2,5 HC/ 5-G - 1923788

### Technical data

#### Thermal tests (C)

Number of positions	12
Conductor cross section	2.5 mm <sup>2</sup>
Test current	16 A
Upper limiting temperature requirements <100 °C	Test passed

#### Climatic tests (D)

Specification	ISO 6988:1985-02
Cold stress	-40 °C/2 h
Thermal stress	100 °C/168 h
Corrosive stress	0.2 dm <sup>3</sup> SO <sub>2</sub> on 300 dm <sup>3</sup> /40 °C/1 cycle
Impulse withstand voltage at sea level	4.8 kV
Power-frequency withstand voltage	2.21 kV

#### Environmental and durability tests (E)

Specification	IEC 61984:2008-10
Result, degree of protection, IP code	Finger safety with IP20 test finger

#### Vibration test

Specification	IEC 60068-2-6:2007-12
Result	Test passed
Frequency	10 - 150 - 10 Hz
Sweep speed	1 octave/min
Amplitude	0.35 mm (10 - 60.1 Hz)
Acceleration	5 g (60.1 - 150 Hz)
Test duration per axis	2.5 h

#### Standards and Regulations

Connection in acc. with standard	EN-VDE
	CUL
Flammability rating according to UL 94	V0

#### Environmental Product Compliance

China RoHS	Environmentally friendly use period: unlimited = EFUP-e
	No hazardous substances above threshold values

### Drawings

# Feed-through header - MSTBA 2,5 HC/ 5-G - 1923788

Drilling diagram

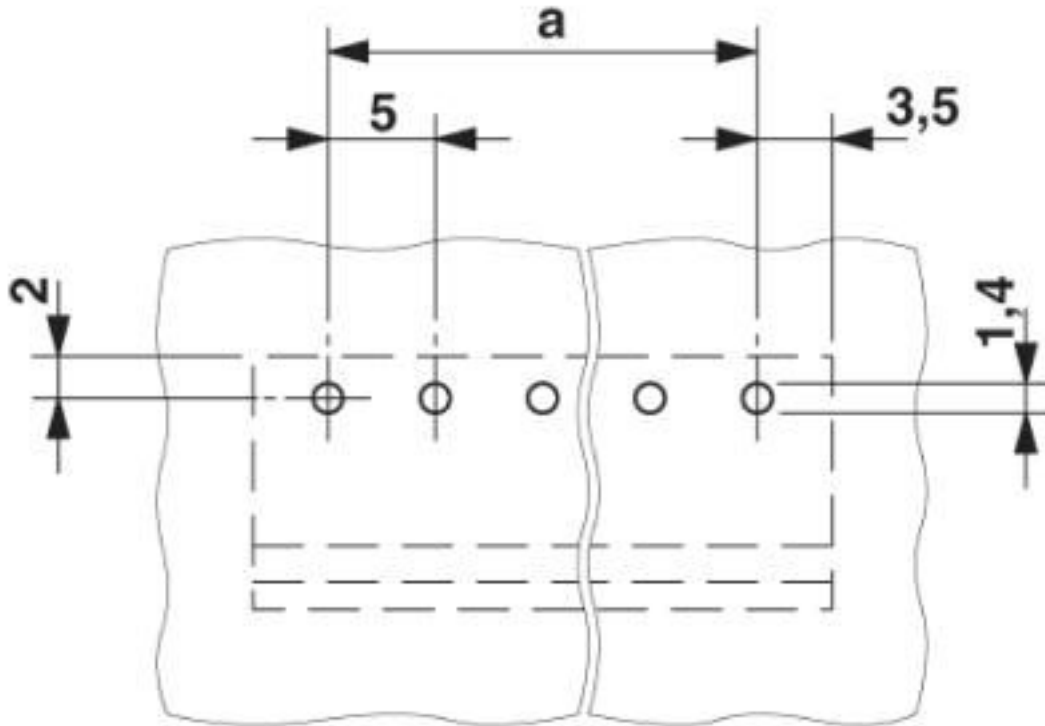

Diagram

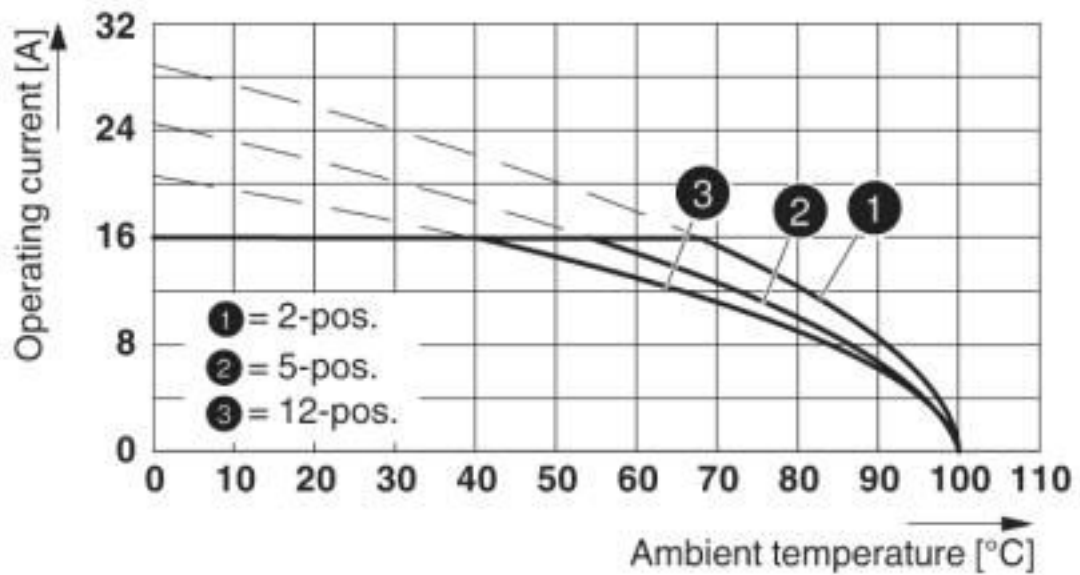

Derating curve for: FK 2,5 HC/...-ST with MSTBA 2,5 HC/...-G

# Feed-through header - MSTBA 2,5 HC/ 5-G - 1923788

Diagram

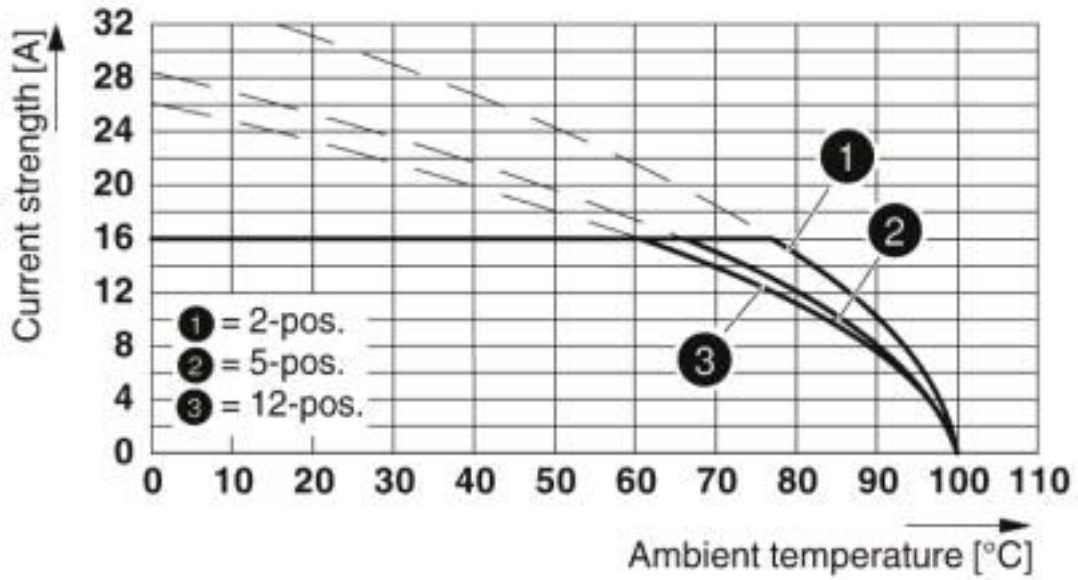

Type: MSTBT 2,5 HC/...-ST with MSTBA 2,5 HC/...-G

Diagram

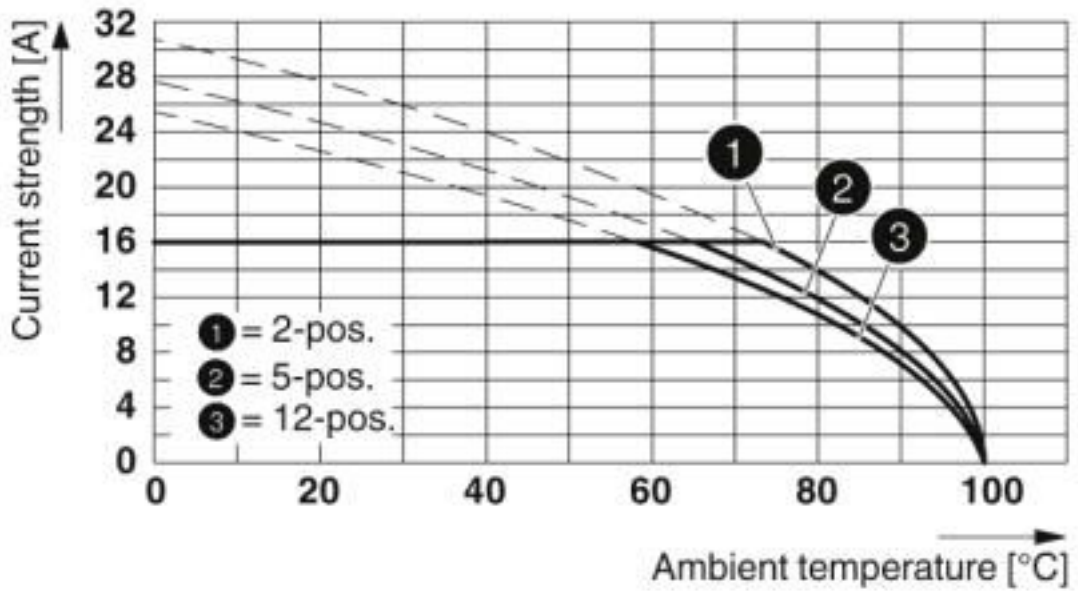

Type: MVSTBR 2,5 HC/...-ST with MSTBA 2,5 HC/...-G

# Feed-through header - MSTBA 2,5 HC/ 5-G - 1923788

Dimensional drawing

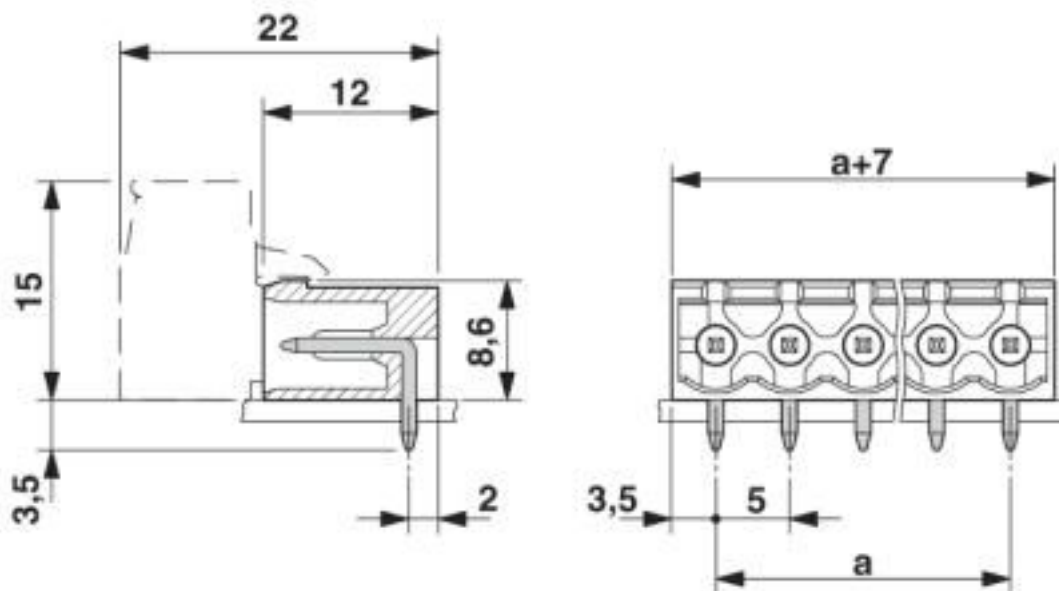

## Classifications

eCl@ss

eCl@ss 10.0.1	27440402
eCl@ss 4.0	27260700
eCl@ss 4.1	27260700
eCl@ss 5.0	27260700
eCl@ss 5.1	27260700
eCl@ss 6.0	27260700
eCl@ss 7.0	27440402
eCl@ss 8.0	27440402
eCl@ss 9.0	27440402

ETIM

ETIM 3.0	EC001121
ETIM 4.0	EC002637
ETIM 5.0	EC002637
ETIM 6.0	EC002637
ETIM 7.0	EC002637

UNSPSC

UNSPSC 6.01	30211810
UNSPSC 7.0901	39121409
UNSPSC 11	39121409
UNSPSC 12.01	39121409
UNSPSC 13.2	39121409

# Feed-through header - MSTBA 2,5 HC/ 5-G - 1923788

## Classifications

### UNSPSC

UNSPSC 18.0	39121409
UNSPSC 19.0	39121409
UNSPSC 20.0	39121409
UNSPSC 21.0	39121409

## Approvals

### Approvals

#### Approvals

IECEE CB Scheme / EAC / cULus Recognized / VDE Zeichengenehmigung

#### Ex Approvals

### Approval details

IECEE CB Scheme		<a href="http://www.iecee.org/">http://www.iecee.org/</a>	DE1-60988-B1B2
Nominal voltage UN	250 V		
Nominal current IN	16 A		

EAC		B.01687
-----	---	---------

cULus Recognized		<a href="http://database.ul.com/cgi-bin/XYV/template/LISEXT/1FRAME/index.htm">http://database.ul.com/cgi-bin/XYV/template/LISEXT/1FRAME/index.htm</a>	E60425-19931011
Nominal voltage UN	B	D	
Nominal current IN	300 V	300 V	
	16 A	10 A	

VDE Zeichengenehmigung		<a href="http://www2.vde.com/de/Institut/Online-Service/VDE-gepruefteProdukte/Seiten/Online-Suche.aspx">http://www2.vde.com/de/Institut/Online-Service/VDE-gepruefteProdukte/Seiten/Online-Suche.aspx</a>	40050079
Nominal voltage UN	250 V		
Nominal current IN	16 A		



## Feed-through header - MSTBA 2,5 HC/ 5-G - 1923788

### Accessories

Accessories

Coding element

Coding section - CR-MSTB - 1734401



Coding section, inserted into the recess in the header or the inverted plug, red insulating material

---

### Filler plug

Accessories - MSTB-BL - 1755477



Keying cap, for forming sections, plugs onto header pin, green insulating material

---

### Labeled terminal marker

Marker card - SK 5/3,8:FORTL.ZAHLEN - 0804183



Marker card, Card, white, labeled, horizontal: consecutive numbers 1 ... 10, 11 ... 20, etc. up to 91 ... (99)100, mounting type: adhesive, for terminal block width: 5 mm, lettering field size: 5 x 3.8 mm

---

### Additional products

Printed-circuit board connector - MSTB 2,5 HC/ 5-ST - 1911884



PCB connector, nominal current: 16 A, rated voltage (III/2): 320 V, nominal cross section: 2.5 mm<sup>2</sup>, number of positions: 5, pitch: 5 mm, connection method: Screw connection with tension sleeve, color: green, contact surface: Tin

---

Printed-circuit board connector - MVSTBR 2,5 HC/ 5-ST - 1912320



PCB connector, nominal current: 16 A, rated voltage (III/2): 320 V, nominal cross section: 2.5 mm<sup>2</sup>, number of positions: 5, pitch: 5 mm, connection method: Screw connection with tension sleeve, color: green, contact surface: Tin

## Feed-through header - MSTBA 2,5 HC/ 5-G - 1923788

### Accessories

---

#### Printed-circuit board connector - MVSTBW 2,5 HC/ 5-ST - 1912760



PCB connector, nominal current: 16 A, rated voltage (III/2): 320 V, nominal cross section: 2.5 mm<sup>2</sup>, number of positions: 5, pitch: 5 mm, connection method: Screw connection with tension sleeve, color: green, contact surface: Tin

---

#### Printed-circuit board connector - MSTBT 2,5 HC/ 5-ST - 1926264



PCB connector, nominal current: 16 A, rated voltage (III/2): 320 V, nominal cross section: 2.5 mm<sup>2</sup>, number of positions: 5, pitch: 5 mm, connection method: Screw connection with tension sleeve, color: green, contact surface: Tin, The T-shape of the MSTBT plug distributes the height uniformly over the upper and lower sides of the printed circuit board

---

#### Printed-circuit board connector - FKC 2,5 HC/ 5-ST - 1942183



PCB connector, nominal current: 16 A, rated voltage (III/2): 320 V, nominal cross section: 2.5 mm<sup>2</sup>, number of positions: 5, pitch: 5 mm, connection method: Push-in spring connection, color: green, contact surface: Tin, COMBICON connectors may only be activated under no load conditions. If for operating reasons small loads must be switched, experimental values are available upon request.

---

Phoenix Contact 2020 © - all rights reserved  
<http://www.phoenixcontact.com>

PHOENIX CONTACT GmbH & Co. KG  
Flachsmarktstr. 8  
32825 Blomberg  
Germany  
Tel. +49 5235 300  
Fax +49 5235 3 41200  
<http://www.phoenixcontact.com>

## X-ON Electronics

Largest Supplier of Electrical and Electronic Components

*Click to view similar products for [Pluggable Terminal Blocks](#) category:*

*Click to view products by [Phoenix Contact](#) manufacturer:*

Other Similar products are found below :

[57.510.0053](#) [MC 1.5/ 6-ST-3.5 GY AU](#) [734-104](#) [734-302](#) [8-141-P](#) [8426620000](#) [860505](#) [860810](#) [GBPACX-12](#) [93.731.4953.0](#) [PV05-5,08-K](#)  
[PVP02-5,00](#) [PVP03-3,50](#) [PVP04-3,50](#) [PVS02-5,00](#) [1-1986160-3](#) [1377680000](#) [1531000000](#) [1546228-5](#) [ELFH16150](#) [ELFP03110](#)  
[ELFP10210](#) [ELFT06250](#) [ELVP03100](#) [1700101](#) [1700410](#) [1700425](#) [1702246](#) [1705229](#) [1710175](#) [1714537](#) [1717806](#) [1719600](#) [1728941](#)  
[1734692](#) [1734795](#) [1736036](#) [1740194](#) [1740291](#) [1740628](#) [1740990](#) [1746952](#) [1750207](#) [1752441](#) [1752865](#) [1754115](#) [1754144](#) [1756913](#)  
[1760051](#) [1760336](#)