

Feed-through header - FK-MPT 0,5/ 9-ICVA-3,5 - 1930548

Please be informed that the data shown in this PDF Document is generated from our Online Catalog. Please find the complete data in the user's documentation. Our General Terms of Use for Downloads are valid (<http://phoenixcontact.com/download>)

PCB headers, nominal current: 3 A, rated voltage (III/2): 250 V, nominal cross section: 0.5 mm², number of positions: 9, pitch: 3.5 mm, color: black, contact surface: Tin, mounting: THR soldering, pin layout: Linear pinning, solder pin [P]: 3.6 mm, The touch-protected basic strip, serves to accommodate the FK-MPT 0,5 PCB terminal block.



The figure shows a 10-position version of the product

Your advantages

- Suitable for wave and reflow soldering processes
- Protection against mismatching thanks to asymmetrical arrangement of sockets
- Vertical connection enables multi-row arrangement on the PCB
- Easy PCB replacement thanks to plug-in modules



Key Commercial Data

Packing unit	50 pc
GTIN	
GTIN	4017918823368

Technical data

Dimensions

Length [l]	9.1 mm
Width	34 mm
Pitch	3.5 mm
Dimension a	28 mm
Width [w]	34 mm
Height [h]	13.6 mm
Installed height	8.8 mm
Length of the solder pin	3.6 mm
Pin dimensions	0.3 x 0.9 mm
Length	9.1 mm

General

Feed-through header - FK-MPT 0,5/ 9-ICVA-3,5 - 1930548

Technical data

General

Range of articles	FK-MPT 0,5/...-ICVA
Insulating material group	IIIa
Rated surge voltage (III/3)	2.5 kV
Rated surge voltage (III/2)	2.5 kV
Rated surge voltage (II/2)	2.5 kV
Rated voltage (III/3)	160 V
Rated voltage (III/2)	250 V
Rated voltage (II/2)	250 V
Connection in acc. with standard	EN-VDE
Nominal current I_N	3 A
Maximum load current	3 A
Insulating material	PA
Flammability rating according to UL 94	V0
Color	black
Number of positions	9

Standards and Regulations

Connection in acc. with standard	EN-VDE
	CUL
Flammability rating according to UL 94	V0

Environmental Product Compliance

China RoHS	Environmentally friendly use period: unlimited = EFUP-e
	No hazardous substances above threshold values

Drawings

Feed-through header - FK-MPT 0,5/ 9-ICVA-3,5 - 1930548

Drilling diagram

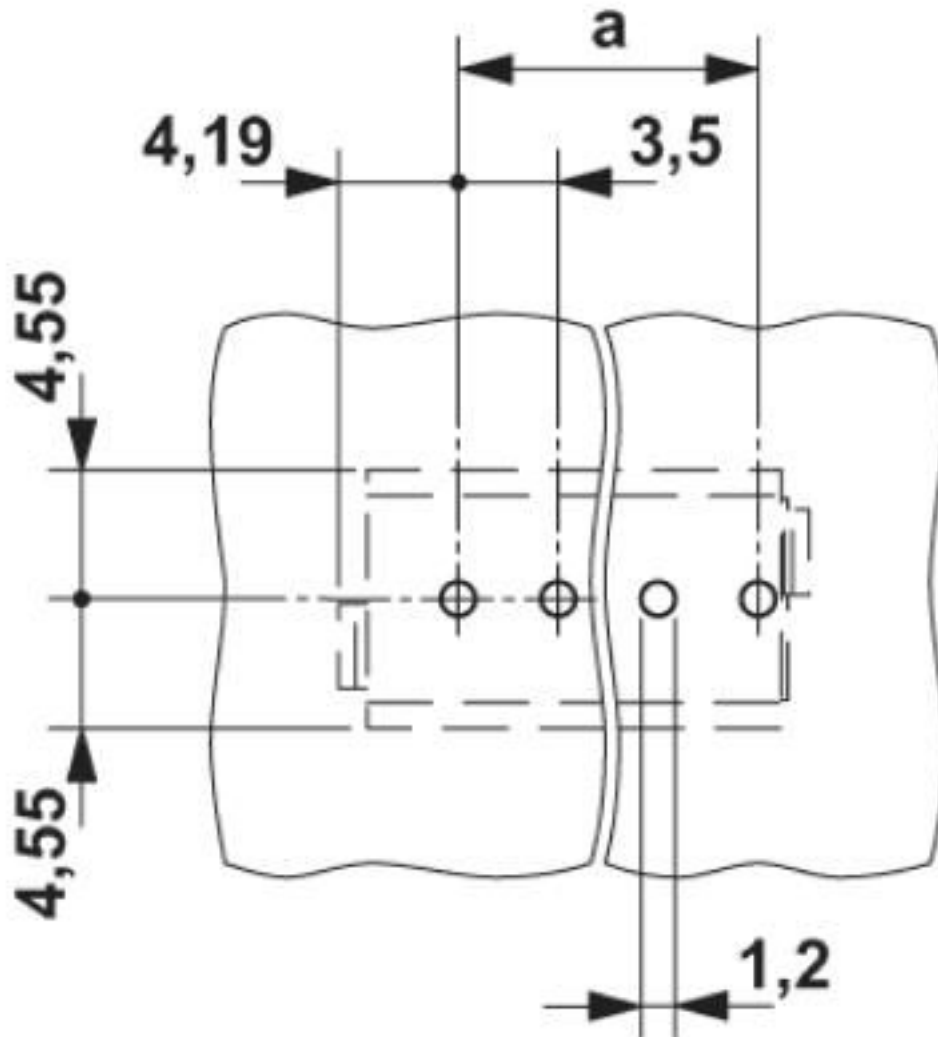

Feed-through header - FK-MPT 0,5/ 9-ICVA-3,5 - 1930548

Dimensional drawing

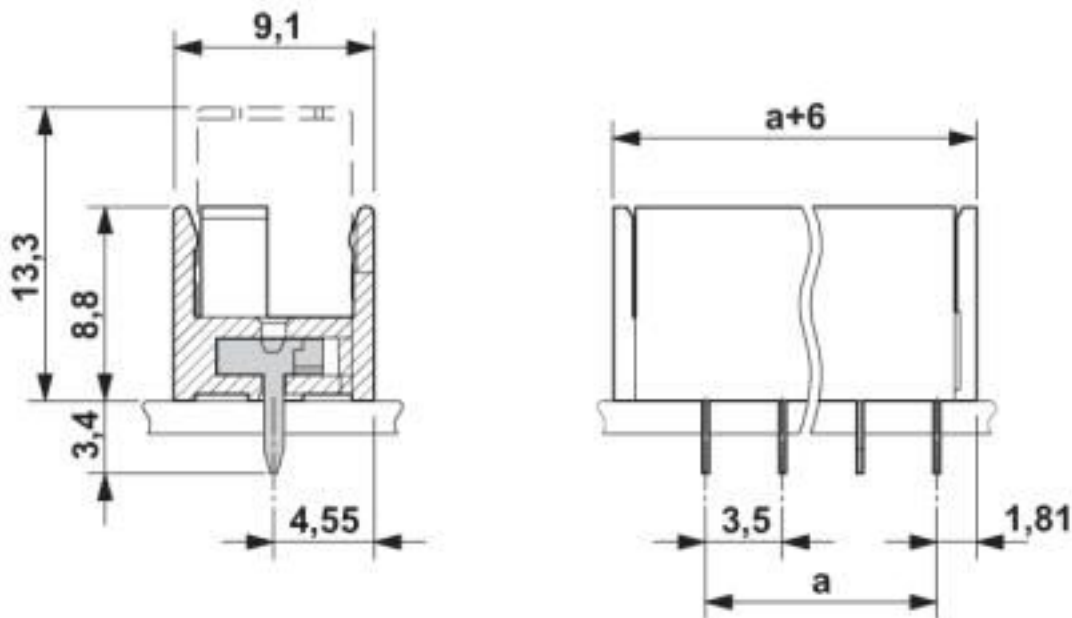

Classifications

eCl@ss

eCl@ss 10.0.1	27440402
eCl@ss 4.0	27260700
eCl@ss 4.1	27260700
eCl@ss 5.0	27260700
eCl@ss 5.1	27260700
eCl@ss 6.0	27260700
eCl@ss 7.0	27440402
eCl@ss 8.0	27440402
eCl@ss 9.0	27440402

ETIM

ETIM 3.0	EC001121
ETIM 4.0	EC002637
ETIM 5.0	EC002637
ETIM 6.0	EC002637
ETIM 7.0	EC002637

UNSPSC

UNSPSC 6.01	30211801
UNSPSC 7.0901	39121432
UNSPSC 11	34131203
UNSPSC 12.01	39121432

Feed-through header - FK-MPT 0,5/ 9-ICVA-3,5 - 1930548

Classifications

UNSPSC

UNSPSC 13.2	39121409
UNSPSC 18.0	39121409
UNSPSC 19.0	39121409
UNSPSC 20.0	39121409
UNSPSC 21.0	39121409

Approvals

Approvals

Approvals

UL Recognized / cUL Recognized / EAC / cULus Recognized

Ex Approvals

Approval details

UL Recognized		http://database.ul.com/cgi-bin/XYV/template/LISEXT/1FRAME/index.htm	FILE E 60425
	B	D	
Nominal voltage UN	300 V	300 V	
Nominal current IN	4 A	4 A	

cUL Recognized		http://database.ul.com/cgi-bin/XYV/template/LISEXT/1FRAME/index.htm	FILE E 60425
	B	D	
Nominal voltage UN	300 V	300 V	
Nominal current IN	4 A	4 A	

EAC		B.01687
-----	--	---------

cULus Recognized	
------------------	--

Phoenix Contact 2020 © - all rights reserved
<http://www.phoenixcontact.com>

PHOENIX CONTACT GmbH & Co. KG
Flachmarktstr. 8
32825 Blomberg
Germany
Tel. +49 5235 300
Fax +49 5235 3 41200
<http://www.phoenixcontact.com>

X-ON Electronics

Largest Supplier of Electrical and Electronic Components

Click to view similar products for [Fixed Terminal Blocks](#) category:

Click to view products by [Phoenix Contact](#) manufacturer:

Other Similar products are found below :

[MBE-1512](#) [MBE-154](#) [MBE-156](#) [MBES-153](#) [MBES-156](#) [MH-2512](#) [MHE-132](#) [MHE-163](#) [MI-254 \(35\)](#) [MI-272](#) [880507](#) [MPT-275](#)
[15602-04-08-21](#) [BA311TU](#) [BA411SU](#) [MV-152](#) [MV-252-D](#) [MV-253/NCNOC](#) [MV-254-D](#) [MV-255](#) [MV-462](#) [MV-493](#) [MVE-252](#) [MVE-253](#)
[MVE-273](#) [MVEB-153](#) [1700096](#) [1705142](#) [1712417](#) [1713020](#) [1713088](#) [1745195](#) [1760594](#) [1776118-2](#) [1790852](#) [1-796689-8](#) [1-796692-6](#)
[1800001](#) [1800114](#) [1995279](#) [20020314-C121B01LF](#) [CB2-12](#) [KP03215000J0G](#) [KP04215000J0G](#) [S451](#) [282802-2](#) [29.007](#) [29.116](#) [30.103](#)
[30.106](#)