

Feed-through header - IC 2,5 HC/ 4-GF-5,08 - 1943441

Please be informed that the data shown in this PDF Document is generated from our Online Catalog. Please find the complete data in the user's documentation. Our General Terms of Use for Downloads are valid (<http://phoenixcontact.com/download>)

PCB headers, nominal current: 16 A, rated voltage (III/2): 320 V, nominal cross section: 2.5 mm², number of positions: 4, pitch: 5.08 mm, color: green, contact surface: Tin, mounting: Wave soldering, pin layout: Linear pinning, solder pin [P]: 3.5 mm, COMBICON connectors may only be activated under no load conditions. If for operating reasons small loads must be switched, experimental values are available upon request.



The figure shows a 10-position version of the product

Your advantages

- Well-known mounting principle allows worldwide use
- Inverted header with socket contacts for touch-proof device outputs or PCB/PCB connections
- Screwable flange for superior mechanical stability
- Integrated double steel spring provides additional safety in the event of temperature and power fluctuations



Key Commercial Data

Packing unit	50 pc
GTIN	
GTIN	4017918878573

Technical data

Item properties

Brief article description	Feed-through header
Plug-in system	POWER COMBICON 2,5
Type of contact	Female connector
Range of articles	IC 2,5 HC/...-GF
Pitch	5.08 mm
Number of positions	4
Mounting type	Wave soldering
Pin layout	Linear pinning
Locking	Threaded flange
Number of levels	1
Number of connections	4

Feed-through header - IC 2,5 HC/ 4-GF-5,08 - 1943441

Technical data

Item properties

Number of potentials	4
----------------------	---

Electrical parameters

Nominal current	16 A
Nom. voltage	320 V
Rated voltage	320 V
Rated voltage (III/2)	320 V
Rated voltage (II/2)	630 V
Rated surge voltage (III/3)	4 kV
Rated surge voltage (III/2)	4 kV
Rated surge voltage (II/2)	4 kV

Material data - contact

Note	WEEE/RoHS-compliant, free of whiskers according to IEC 60068-2-82/ JEDEC JESD 201
Contact material	Cu alloy
Metal surface contact area (top layer)	Tin (4 - 8 µm Sn)
Metal surface contact area (middle layer)	Nickel (2 - 3 µm Ni),
Metal surface soldering area (top layer)	Tin (5 - 7 µm Sn)
Metal surface soldering area (middle layer)	Nickel (2 - 3 µm Ni)

Material data - housing

Housing color	green (6021)
Insulating material	PA
Insulating material group	I
CTI according to IEC 60112	600
Flammability rating according to UL 94	V0
Glow wire flammability index GWFI according to EN 60695-2-12	850
Glow wire ignition temperature GWIT according to EN 60695-2-13	775
Temperature for the ball pressure test according to EN 60695-10-2	125 °C

Dimensions for the product

Length [l]	19 mm
Width [w]	30.44 mm
Height [h]	13.7 mm
Pitch	5.08 mm
Height (without solder pin)	10.2 mm
Solder pin [P]	3.5 mm
Pin spacing	5.08 mm
Pin dimensions	0.48 x 1.14 mm

Dimensions for PCB design

Hole diameter	1.4 mm
Pin spacing	5.08 mm

Feed-through header - IC 2,5 HC/ 4-GF-5,08 - 1943441

Technical data

Packaging information

Type of packaging	packed in cardboard
Pieces per package	50
Denomination packing units	Pcs.

Standards and Regulations

Connection in acc. with standard	EN-VDE
	CUL
Flammability rating according to UL 94	V0

Environmental Product Compliance

REACH SVHC	Lead 7439-92-1
China RoHS	Environmentally Friendly Use Period = 50 years
	For details about hazardous substances go to tab "Downloads", Category "Manufacturer's declaration"

Drawings

Feed-through header - IC 2,5 HC/ 4-GF-5,08 - 1943441

Drilling diagram

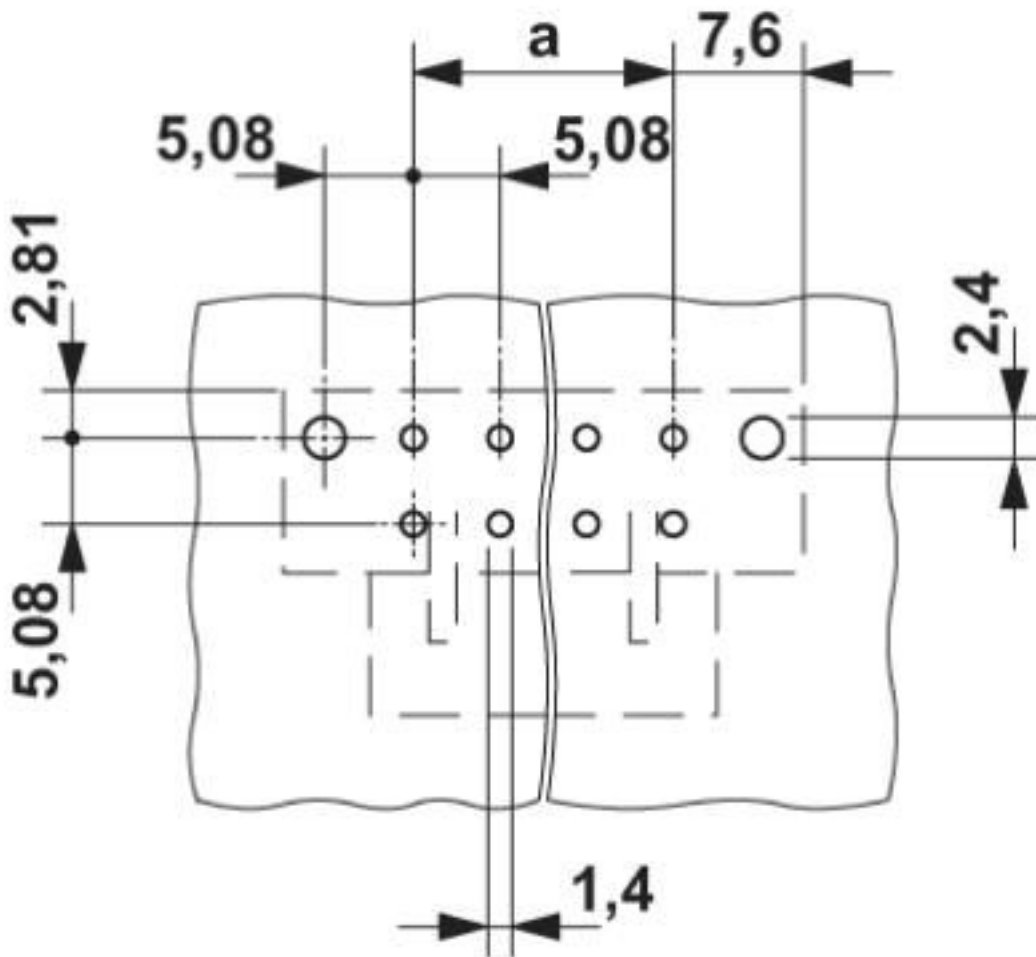

Dimensional drawing

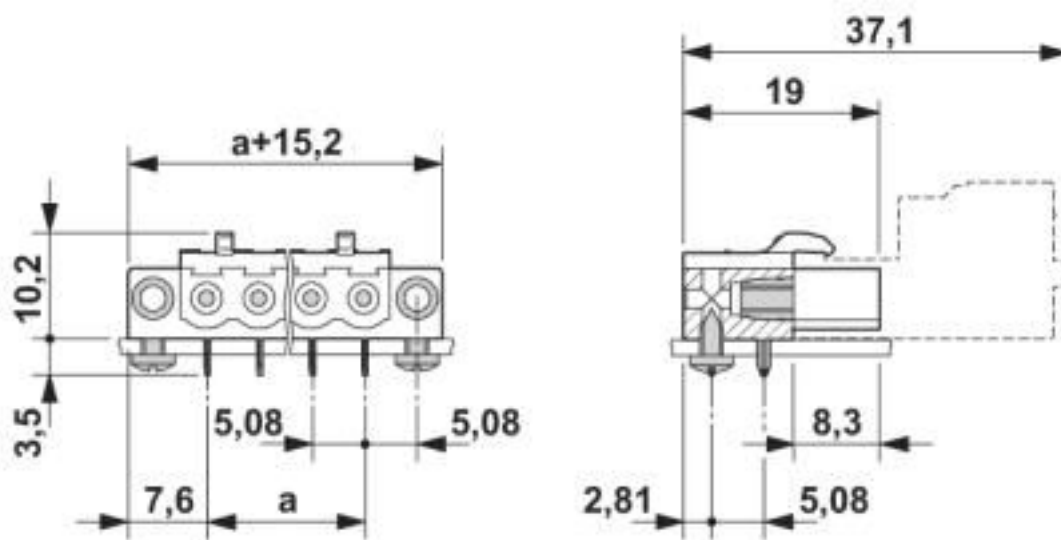

Feed-through header - IC 2,5 HC/ 4-GF-5,08 - 1943441

Classifications

eCl@ss

eCl@ss 10.0.1	27440402
eCl@ss 4.0	27260700
eCl@ss 4.1	27260700
eCl@ss 5.0	27260700
eCl@ss 5.1	27260700
eCl@ss 6.0	27260700
eCl@ss 7.0	27440402
eCl@ss 8.0	27440402
eCl@ss 9.0	27440402

ETIM

ETIM 3.0	EC001121
ETIM 4.0	EC002637
ETIM 5.0	EC002637
ETIM 6.0	EC002637
ETIM 7.0	EC002637

UNSPSC

UNSPSC 6.01	30211810
UNSPSC 7.0901	39121409
UNSPSC 11	39121409
UNSPSC 12.01	39121409
UNSPSC 13.2	39121409
UNSPSC 18.0	39121409
UNSPSC 19.0	39121409
UNSPSC 20.0	39121409
UNSPSC 21.0	39121409

Approvals

Approvals

Approvals

IECEE CB Scheme / EAC / cULus Recognized / VDE Zeichengenehmigung

Ex Approvals

Approval details

Feed-through header - IC 2,5 HC/ 4-GF-5,08 - 1943441

Approvals

IECEE CB Scheme	CB scheme	http://www.iecee.org/	DE1-60988-B1B2
Nominal voltage UN		250 V	
Nominal current IN		16 A	

EAC	EAC	B.01687
-----	------------	---------

cULus Recognized	cULus	http://database.ul.com/cgi-bin/XYV/template/LISEXT/1FRAME/index.htm	E60425-19931014
		B	D
Nominal voltage UN		250 V	300 V
Nominal current IN		16 A	10 A

VDE Zeichengenehmigung		http://www2.vde.com/de/Institut/Online-Service/VDE-gepruefteProdukte/Seiten/Online-Suche.aspx	40050079
Nominal voltage UN		250 V	
Nominal current IN		16 A	

Accessories

Accessories

Coding element

Coding profile - CP-MSTB - 1734634

Coding profile, is inserted into the slot on the plug or inverted header, red insulating material



Insulating sleeve

Feed-through header - IC 2,5 HC/ 4-GF-5,08 - 1943441

Accessories

Insulating sleeve - MPS-IH WH - 0201663

Insulating sleeve, color: white



Insulating sleeve - MPS-IH RD - 0201676

Insulating sleeve, color: red



Insulating sleeve - MPS-IH BU - 0201689

Insulating sleeve, color: blue



Insulating sleeve - MPS-IH YE - 0201692

Insulating sleeve, color: yellow



Insulating sleeve - MPS-IH GN - 0201702

Insulating sleeve, color: green



Feed-through header - IC 2,5 HC/ 4-GF-5,08 - 1943441

Accessories

Insulating sleeve - MPS-IH BK - 0201731

Insulating sleeve, color: black



Test plug terminal block

Reducing plug - RPS - 0201647



Reducing plug, color: gray

Test plugs - MPS-MT - 0201744



Test plugs, with solder connection up to 1 mm² conductor cross section, color: gray

Additional products

Printed-circuit board connector - FKIC 2,5 HC/ 4-STF-5,08 - 1942727



PCB connector, nominal current: 16 A, rated voltage (III/2): 320 V, nominal cross section: 2.5 mm², number of positions: 4, pitch: 5.08 mm, connection method: Push-in spring connection, color: green, contact surface: Tin

X-ON Electronics

Largest Supplier of Electrical and Electronic Components

Click to view similar products for [Pluggable Terminal Blocks](#) category:

Click to view products by [Phoenix Contact](#) manufacturer:

Other Similar products are found below :

[57.510.0053](#) [MC 1.5/ 6-ST-3.5 GY AU](#) [734-104](#) [734-302](#) [8-141-P](#) [8426620000](#) [860505](#) [860516](#) [860810](#) [GBPACX-12](#) [93.731.4953.0](#) [PV05-5,08-K](#) [PVP02-5,00](#) [PVP03-3,50](#) [PVP04-3,50](#) [PVS02-5,00](#) [1-1986160-3](#) [1377680000](#) [1531000000](#) [1546228-5](#) [ELFH16150](#) [ELFP03110](#) [ELFP10210](#) [ELFT06250](#) [ELVP03100](#) [1700101](#) [1700410](#) [1700425](#) [1702246](#) [1705229](#) [1710175](#) [1714537](#) [1717806](#) [1719600](#) [1728941](#) [1734692](#) [1734795](#) [1736036](#) [1740194](#) [1740291](#) [1740628](#) [1740990](#) [1746952](#) [1750207](#) [1752441](#) [1752865](#) [1754115](#) [1754144](#) [1756913](#) [1760051](#)