

Printed-circuit board connector - ICV 2,5 HC/11-G-5,08 - 1943629

Please be informed that the data shown in this PDF Document is generated from our Online Catalog. Please find the complete data in the user's documentation. Our General Terms of Use for Downloads are valid (<http://phoenixcontact.com/download>)



PCB headers, nominal current: 16 A, rated voltage (III/2): 320 V, nominal cross section: 2.5 mm², number of positions: 11, pitch: 5.08 mm, color: green, contact surface: Tin, mounting: Wave soldering, pin layout: Linear pinning, solder pin [P]: 3.6 mm, COMBICON connectors may only be activated under no load conditions. If for operating reasons small loads must be switched, experimental values are available upon request.

The figure shows a 10-position version of the product

Your advantages

- Well-known mounting principle allows worldwide use
- Inverted header with socket contacts for touch-proof device outputs or PCB/PCB connections
- Integrated double steel spring provides additional safety in the event of temperature and power fluctuations



Key Commercial Data

Packing unit	50 pc
GTIN	 4 017918 878702
GTIN	4017918878702

Technical data

Item properties

Brief article description	Feed-through header
Plug-in system	POWER COMBICON 2,5
Type of contact	Female connector
Range of articles	ICV 2,5 HC/..-G
Pitch	5.08 mm
Number of positions	11
Mounting type	Wave soldering
Pin layout	Linear pinning
Locking	without
Number of levels	1
Number of connections	11
Number of potentials	11

Printed-circuit board connector - ICV 2,5 HC/11-G-5,08 - 1943629

Technical data

Electrical parameters

Nominal current	16 A
Nom. voltage	320 V
Rated voltage	320 V
Rated voltage (III/2)	320 V
Rated voltage (II/2)	630 V
Rated surge voltage (III/3)	4 kV
Rated surge voltage (III/2)	4 kV
Rated surge voltage (II/2)	4 kV

Material data - contact

Note	WEEE/RoHS-compliant, free of whiskers according to IEC 60068-2-82/ JEDEC JESD 201
Contact material	Cu alloy
Surface characteristics	hot-dip tin-plated
Metal surface contact area (top layer)	Tin (4 - 8 µm Sn)
Metal surface soldering area (top layer)	Tin (4 - 8 µm Sn)

Material data - housing

Housing color	green (6021)
Insulating material	PA
Insulating material group	I
CTI according to IEC 60112	600
Flammability rating according to UL 94	V0
Glow wire flammability index GWFI according to EN 60695-2-12	850
Glow wire ignition temperature GWIT according to EN 60695-2-13	775
Temperature for the ball pressure test according to EN 60695-10-2	125 °C

Dimensions for the product

Length [l]	10.2 mm
Width [w]	57.88 mm
Height [h]	22.6 mm
Pitch	5.08 mm
Height (without solder pin)	19 mm
Solder pin [P]	3.6 mm
Pin dimensions	1.2 x 0.5 mm

Dimensions for PCB design

Hole diameter	1.4 mm
---------------	--------

Packaging information

Type of packaging	packed in cardboard
Pieces per package	50
Denomination packing units	Pcs.

Printed-circuit board connector - ICV 2,5 HC/11-G-5,08 - 1943629

Technical data

Ambient conditions

Ambient temperature (storage/transport)	-40 °C ... 70 °C
Ambient temperature (assembly)	-5 °C ... 100 °C
Ambient temperature (operation)	-40 °C ... 100 °C (dependent on the derating curve)

Air clearances and creepage distances

Clearances and creepage distances	IEC 60664-1:2007-04
Specification	IEC 60664-1:2007-04
Minimum clearance - inhomogeneous field (III/3)	3 mm
Minimum clearance - inhomogeneous field (III/2)	3 mm
Minimum clearance - inhomogeneous field (II/2)	3 mm
Minimum creepage distance value (III/3)	4 mm
Minimum creepage distance value (III/2)	3 mm
Minimum creepage distance value (II/2)	3.2 mm

Mechanical tests (A)

Test specification	IEC 61984
Insertion strength per pos. approx.	12 N
Withdraw strength per pos. approx.	10 N
Polarization when inserted requirement >20 N	Test passed
Contact holder in insert requirements >20 N	Test passed

Durability tests (B)

Specification	IEC 60512-9-1:2010-03
Contact resistance R ₁	1.5 mΩ
Insertion/withdrawal cycles	25
Contact resistance R ₂	1.6 mΩ
Impulse withstand voltage at sea level	4.8 kV
Power-frequency withstand voltage	2.21 kV
Insulation resistance, neighboring positions	> 0.1 TΩ

Thermal tests (C)

Specification	IEC 60512-5-1:2002-02
Number of positions	12
Conductor cross section	2.5 mm ²
Test current	16 A
Upper limiting temperature requirements <100 °C	Test passed

Climatic tests (D)

Specification	ISO 6988:1985-02
Cold stress	-40 °C/2 h
Thermal stress	100 °C/168 h
Corrosive stress	0.2 dm ³ SO ₂ on 300 dm ³ /40 °C/1 cycle
Impulse withstand voltage at sea level	4.8 kV

Printed-circuit board connector - ICV 2,5 HC/11-G-5,08 - 1943629

Technical data

Climatic tests (D)

Power-frequency withstand voltage	2.21 kV
-----------------------------------	---------

Environmental and durability tests (E)

Specification	IEC 61984:2008-10
Result, degree of protection, IP code	Finger safety with IP20 test finger

Vibration test

Specification	IEC 60068-2-6:2007-12
Result	Test passed
Frequency	10 - 150 - 10 Hz
Sweep speed	1 octave/min
Amplitude	0.35 mm (10 - 60.1 Hz)
Acceleration	5 g (60.1 - 150 Hz)
Test duration per axis	2.5 h

Standards and Regulations

Connection in acc. with standard	EN-VDE
	CUL
Flammability rating according to UL 94	V0

Environmental Product Compliance

China RoHS	Environmentally friendly use period: unlimited = EFUP-e
	No hazardous substances above threshold values

Drawings

Printed-circuit board connector - ICV 2,5 HC/11-G-5,08 - 1943629

Drilling diagram

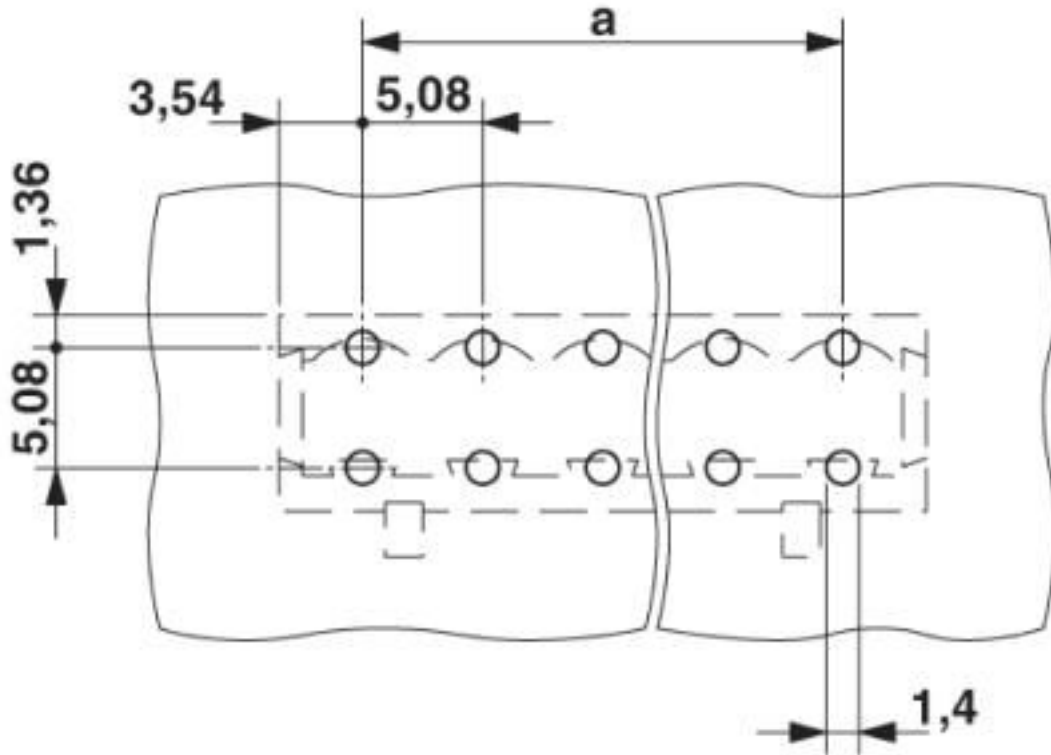

Diagram

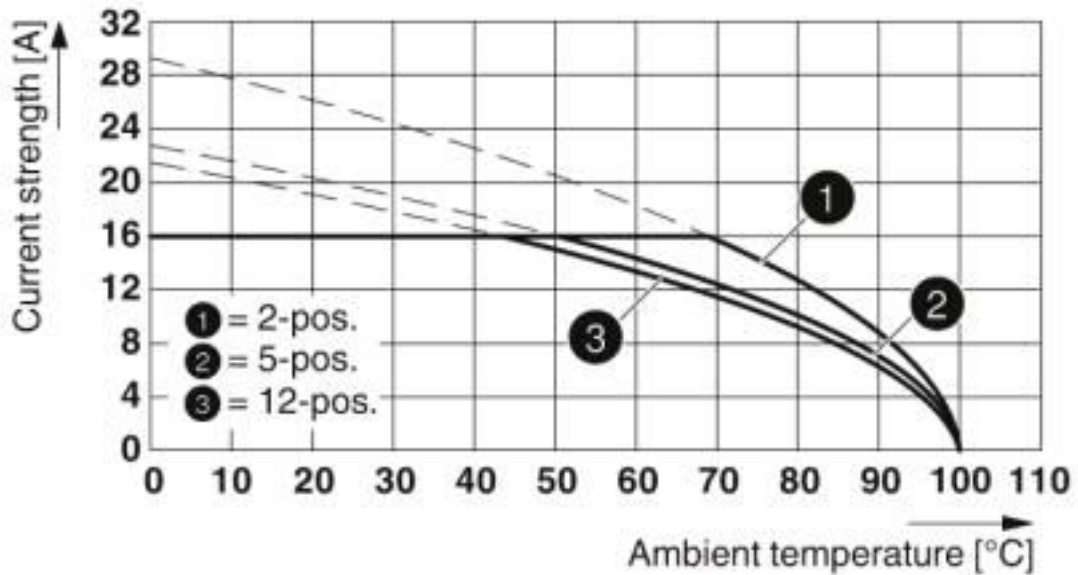

Type: FKIC 2,5 HC/...-ST- 5,08 with ICV 2,5 HC/...-G-5,08

Printed-circuit board connector - ICV 2,5 HC/11-G-5,08 - 1943629

Dimensional drawing

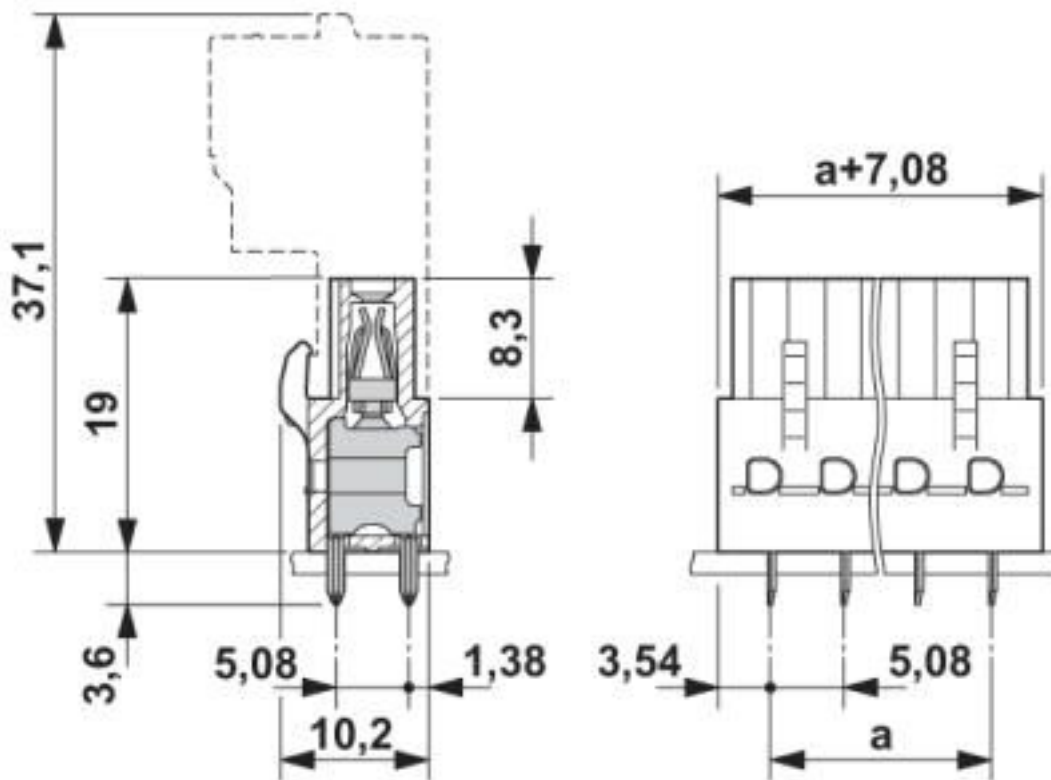

Classifications

eCl@ss

eCl@ss 10.0.1	27440402
eCl@ss 4.0	27260700
eCl@ss 4.1	27260700
eCl@ss 5.0	27260700
eCl@ss 5.1	27260700
eCl@ss 6.0	27260700
eCl@ss 7.0	27440402
eCl@ss 8.0	27440402
eCl@ss 9.0	27440402

ETIM

ETIM 3.0	EC001121
ETIM 4.0	EC002637
ETIM 5.0	EC002637
ETIM 6.0	EC002637
ETIM 7.0	EC002637

Printed-circuit board connector - ICV 2,5 HC/11-G-5,08 - 1943629

Classifications

UNSPSC

UNSPSC 6.01	30211810
UNSPSC 7.0901	39121409
UNSPSC 11	39121409
UNSPSC 12.01	39121409
UNSPSC 13.2	39121409
UNSPSC 18.0	39121409
UNSPSC 19.0	39121409
UNSPSC 20.0	39121409
UNSPSC 21.0	39121409

Approvals

Approvals

Approvals

IECEE CB Scheme / EAC / cULus Recognized / VDE Zeichengenehmigung

Ex Approvals

Approval details

IECEE CB Scheme		http://www.iecee.org/	DE1-60988-B1B2
Nominal voltage UN	250 V		
Nominal current IN	16 A		

EAC		B.01687
-----	---	---------

cULus Recognized		http://database.ul.com/cgi-bin/XYV/template/LISEXT/1FRAME/index.htm	E60425-19931014
	B	D	
Nominal voltage UN	250 V	300 V	
Nominal current IN	16 A	10 A	

Printed-circuit board connector - ICV 2,5 HC/11-G-5,08 - 1943629

Approvals

VDE Zeichengenehmigung		http://www2.vde.com/de/Institut/Online-Service/VDE-gepruefteProdukte/Seiten/Online-Suche.aspx	40050079
Nominal voltage UN		250 V	
Nominal current IN		16 A	

Accessories

Accessories

Coding element

Coding profile - CP-MSTB - 1734634

Coding profile, is inserted into the slot on the plug or inverted header, red insulating material



Insulating sleeve

Insulating sleeve - MPS-IH WH - 0201663

Insulating sleeve, color: white



Insulating sleeve - MPS-IH RD - 0201676

Insulating sleeve, color: red



Insulating sleeve - MPS-IH BU - 0201689

Insulating sleeve, color: blue



Printed-circuit board connector - ICV 2,5 HC/11-G-5,08 - 1943629

Accessories

Insulating sleeve - MPS-IH YE - 0201692

Insulating sleeve, color: yellow



Insulating sleeve - MPS-IH GN - 0201702

Insulating sleeve, color: green



Insulating sleeve - MPS-IH BK - 0201731

Insulating sleeve, color: black



Test plug terminal block

Reducing plug - RPS - 0201647



Reducing plug, color: gray

Test plugs - MPS-MT - 0201744



Test plugs, with solder connection up to 1 mm² conductor cross section, color: gray

Additional products

Printed-circuit board connector - ICV 2,5 HC/11-G-5,08 - 1943629

Accessories

Feed-through header - MSTBA 2,5 HC/11-G-5,08 - 1923953

PCB headers, nominal current: 16 A, rated voltage (III/2): 320 V, nominal cross section: 2.5 mm², number of positions: 11, pitch: 5.08 mm, color: green, contact surface: Tin, mounting: Wave soldering, pin layout: Linear pinning, solder pin [P]: 3.5 mm



Feed-through header - MSTBVA 2,5 HC/11-G-5,08 - 1924392

PCB headers, nominal current: 16 A, rated voltage (III/2): 320 V, nominal cross section: 2.5 mm², number of positions: 11, pitch: 5.08 mm, color: green, contact surface: Tin, mounting: Wave soldering, pin layout: Linear pinning, solder pin [P]: 3.9 mm



Printed-circuit board connector - FKIC 2,5 HC/11-ST-5,08 - 1942688

PCB connector, nominal current: 16 A, rated voltage (III/2): 320 V, nominal cross section: 2.5 mm², number of positions: 11, pitch: 5.08 mm, connection method: Push-in spring connection, color: green, contact surface: Tin



Phoenix Contact 2020 © - all rights reserved
<http://www.phoenixcontact.com>

PHOENIX CONTACT GmbH & Co. KG
Flachsmarktstr. 8
32825 Blomberg
Germany
Tel. +49 5235 300
Fax +49 5235 3 41200
<http://www.phoenixcontact.com>

X-ON Electronics

Largest Supplier of Electrical and Electronic Components

Click to view similar products for [Fixed Terminal Blocks](#) category:

Click to view products by [Phoenix Contact](#) manufacturer:

Other Similar products are found below :

[MBE-1512](#) [MBE-154](#) [MBE-156](#) [MBES-153](#) [MBES-156](#) [MH-2512](#) [MHE-132](#) [MHE-163](#) [MI-254 \(35\)](#) [MI-272](#) [880507](#) [MPT-275](#)
[15602-04-08-21](#) [BA311TU](#) [BA411SU](#) [MV-152](#) [MV-252-D](#) [MV-253/NCNOC](#) [MV-254-D](#) [MV-255](#) [MV-462](#) [MV-493](#) [MVE-252](#) [MVE-253](#)
[MVE-273](#) [MVEB-153](#) [1700096](#) [1705142](#) [1712417](#) [1713020](#) [1713088](#) [1745195](#) [1760594](#) [1776118-2](#) [1790852](#) [1-796689-8](#) [1-796692-6](#)
[1800001](#) [1800114](#) [1995279](#) [20020314-C121B01LF](#) [CB2-12](#) [KP03215000J0G](#) [KP04215000J0G](#) [S451](#) [282802-2](#) [29.007](#) [29.116](#) [30.103](#)
[30.106](#)